

Collar nut M42 DIN6331 Grade 10, crack tested, height: 1.5 x M

Artikel-Nr: 7991020

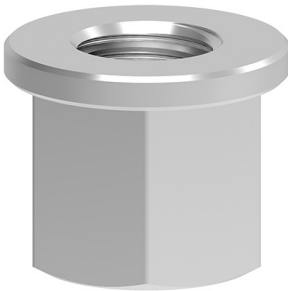

Collar nuts for attachment points that are frequently assembled and disassembled in through bolts.

- 100% crack tested
- Nut height: 1.5 x d
- Finish: galvanised/ zinc-flake coating

Collar nut M42 DIN6331 Grade 10, crack tested, height: 1.5 x M

Artikel-Nr: 7991020

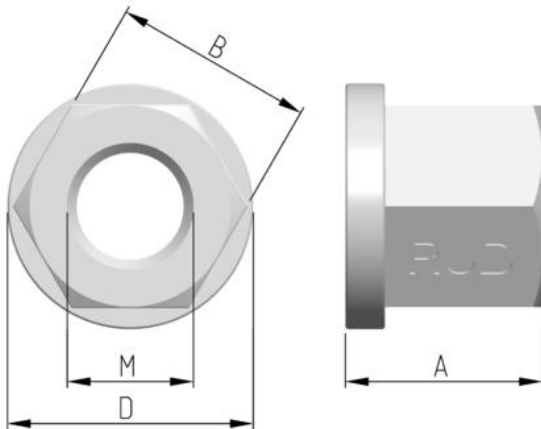

weight	1.34 kg	2.95 lbs
A	63 mm	2-15/32"
B	65 mm	2-9/16"
D	80 mm	3-1/8"
M	M42 mm	M42