



Industrial: Valves



Ball Valves

*Brass, Carbon Steel & Stainless Steel
Padlocking & Vented Options
Handle Options
Inch & Metric
UL Listed
90° Valves
Actuators*



Needle Valves

































*Fine Threaded for control and
positive seal
All Brass construction
Metal to Metal Seats*









































Ground Plug Shutoff / Drain Cocks

*External & Internal Seat
Metal to Metal Seats
Economical*

















Female Ports	XV500P Female-Female  p. K6	XV502P Panel Mount  p. K11	XV520P Economy Series  p. K17	XV533P 3 Way Diversion  p. K19	XV540P 4 Way  p. K19	XV600P 6 Port Diversion  p. K24
	XV633P 6 Port Diversion  p. K24	XV500CS Carbon Steel  p. K26	XV502CS Panel Mount Carbon Steel  p. K26	XV502SS Panel Mount Stainless  p. K34	MV709 Micro Valve  p. K47	MV200 Mini Valve  p. K52
PV609 Plug Valve  p. K54	Male-Female Ports	XV501P Male-Female  p. K9	XV590P 90° Valve  p. K21	XV590P-X-04 90° Valve  p. K21	XV501SS Stainless Steel  p. K32	MV708 Micro Valve  p. K47
MV608 Mini Valve  p. K52		PV608 Plug Valve  p. K54	Solder Ports	XV509P Solder - Solder  p. K14	Male-Male Ports	XV591P 90° Valve  p. K21
PV607 Plug Valve  p. K54	Straight Thread Ports	XV506P Female - Female  p. K13		XV510P Male - Female  p. K16		XV506CS Carbon Steel  p. K28
Female Ports-High Pressure		XV500HP Female Ports  p. K30	Female Ports-Padlocking-High Pressure	XVP500HP Female Ports-Padlocking  p. K30	Barb to Female Port	XV500HB Barb to Female Port  p. K22
	Padlocking	XVP500P Female Ports  p. K6		XVP501P Male - Female  p. K9		XVP502P Panel Mount  p. K11
XVP502SS Stainless Steel  p. K34		Straight Thread Ports-Padlocking-High Pressure	XVP506HP Straight Thread  p. K31	Vented	XVV500P Female Ports  p. K6	XVV501P Male-Female  p. K9

K

Vented-Padlocking	XVVP500P Female Ports  p. K6	XVVP501P Male-Female  p. K9	XVVP502P Panel Mount  p. K11	Tee Handle	XV500P-X-04 Female Ports  p. K7	XV501P-X-04 Male - Female  p. K9
	XV502P-X-04 Panel Mount  p. K11	XV510P-X-04 Straight Thread  p. K16	XV500CS-X-04 Carbon Steel  p. K26		Oval Handle	XV500P-X-21 Female Ports  p. K7
XV510P-X-21 Straight Thread  p. K16	XV500CS-X-21 Carbon Steel  p. K27	XV502CS-X-21 Panel Mount - Carbon Steel  p. K27	XV502SS-X-21 Oval Handle  p. K34	Short Handle		XV502SS-X-20 Panel Mount  p. K34
Metric Female Ports	BVGC Female Ports  p. K39	BVGC Female Ports  p. K39	BVGL Female Ports Long  p. K41		BVGL Female Ports Long  p. K41	MBVG Compact  p. K45
	Metric Padlocking	BVG4PLOCK Female Ports  p. K43	Needle Valves	NV101F Female - Male  p. K56	NV102F Flare  p. K56	NV103F Flare - Male Pipe  p. K56
NV105C-NV105CA Compression  p. K56		NV106C-NV106CA Compression - Pipe  p. K57		NV107P Pipe  p. K57	NV108P Female - Male  p. K57	NV109P Female  p. K57
Shutoff Valves	V203F Flare  p. K59	V204F Flare - Pipe  p. K59	V303C-V303CA Compression  p. K59	V304C-V304CA Compression - Pipe  p. K59	V401P Pipe  p. K59	V402P Female - Pipe  p. K59
	V403P Female  p. K59	V406P 3 Way  p. K59	V407P 4 Way  p. K59	DC601 Pipe  p. K59	Drain Cocks	DCR601 Internal Seal  p. K60



<p>DC603 Internal Seal</p>  <p>p. K60</p>	<p>DC604 External Seal</p>  <p>p. K60</p>	<p>DC606 External Seal</p>  <p>p. K60</p>	<p>DC607 Bib Drain</p>  <p>p. K60</p>	<p>Auxiliary</p>	<p>XV502P-X-ACT Actuator</p>  <p>p. K36</p>	<p>XV502SS-X-ACT Actuator</p>  <p>p. K36</p>
<p>XV502P-X-SUB Sub-Assembly</p>  <p>p. K37</p>	<p>XV502SS-X-SUB Sub-Assembly</p>  <p>p. K37</p>	<p>ACT-P-X-KIT Brass Actuator kit</p>  <p>p. K37</p>	<p>ACT-SS-X-KIT Stainless Actuator Kit</p>  <p>p. K37</p>	<p>STX-P Stem Extension</p>  <p>p. K50</p>	<p>PVMB-001 Mounting Bracket</p>  <p>p. K54</p>	<p>HV104C-KIT Humidifier Valve Kit</p>  <p>p. K56</p>
<p>SPV104C-KIT Self Piercing Kit</p>  <p>p. K56</p>	<p>HV104C Humidifier Valve</p>  <p>p. K56</p>					

K



Brass Ball Valves Series 500

MATERIALS OF CONSTRUCTION	
VALVE BODY:	FORGED BRASS
BALL:	CHROME PLATED BRASS
SEATS / SEALS:	PTFE
HANDLE:	STEEL

STYLE	TYPE	MATERIAL	SIZE	OPTIONS
V	500	P	-4	-00
STYLE	<ul style="list-style-type: none"> • V-VALVE* • VP-VALVE, PADLOCKING HANDLE* • VV-VALVE, VENTED • VVP-VALVE, VENTED, PADLOCKING HANDLE 			
TYPE	500-FEMALE/FEMALE PTF PORTS 500-FEMALE/FEMALE NPT PORTS*			
MATERIAL	P- BRASS* PN-NICKEL PLATED			
SIZE	4-1/4", 6-3/8", 8-1/2", 12-3/4", 16-1", 20-1 1/4", 24-1 1/2", 32-2"			
OPTIONS	<ul style="list-style-type: none"> • 01-STAINLESS STEEL BALL & STEM • 02-STAINLESS STEEL HANDLE & NUT* • 03-STAINLESS STEEL BALL, STEM, HANDLE & NUT • 04-TEE HANDLE* • 08-UNMARKED YELLOW VINYL HANDLE COVER* • 21-OVAL HANDLE 			



SPECIFICATIONS	
OPERATING INSTRUCTIONS:	QUARTER TURN IS "ON" OR "OFF". (PROVIDES POSITIVE STOP ACTION FOR FULL SHUTOFF.)
PRESSURE RANGE:	<ul style="list-style-type: none"> • 600 WOG, COLD NON-SHOCK • SATURATED STEAM UP TO 150 PSI • VACUUM SERVICE TO 29 INCHES HG. • VENTED UP TO 250 PSI
TEMPERATURE RANGES:	0° TO +350°F
NOTE:	PERIODICALLY CHECK THE ADJUSTABLE PACKING NUT AND TIGHTEN AS REQUIRED.

Parker's industrial ball valve product line is intended for general purpose use. Please be aware that ball valves are intended for use in the fully open or closed positions. Depending on application conditions, throttling of the valve may result in premature seal failure and/or inability to turn the valve handle.

For use as fuel line shutoffs for gasoline and diesel powered over the highway, off highway, and construction equipment vehicles. Water and air service lines on capital equipment and plant design plumbing that require total shutoff capability.

FLOW DATA	
VALVE SIZE	CV
1/4	4.0
3/8	5.8
1/2	12.0
3/4	25.0
1	35.0
1-1/4*	57.0
1-1/2*	92.0
2*	224.0

*For these part numbers only the * options are available.

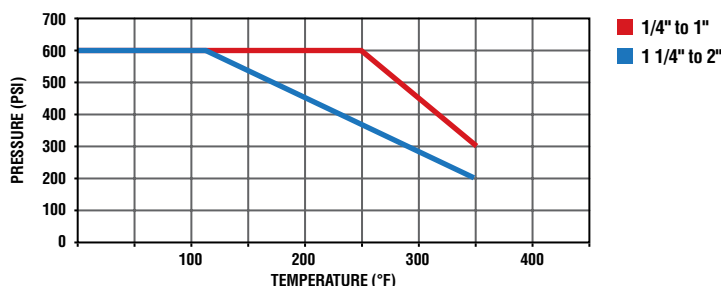

Female-Female Pipe Ends XV500P

PART NO.	PIPE THREAD	B HEX	C HEX	H	L	M	N	FLOW DIA. D
XV500P-4	1/4	15/16	15/16	3.96	4.90	2.03	2.47	.375
XV500P-6	3/8	15/16	15/16	3.96	4.90	2.03	2.47	.375
XV500P-8	1/2*	1-1/16	1-1/16	3.96	5.00	2.20	2.58	.500
XV500P-12	3/4**	1-1/4	1-5/16	3.96	5.25	2.42	2.81	.685
XV500P-16	1**	1-1/2	1-9/16	3.96	5.34	2.75	3.08	.875

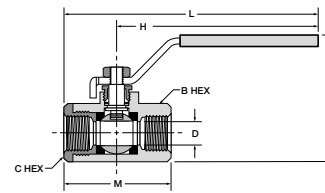

Female-Female Pipe Ends XV500P-20, XV500P-24, XV500P-32

PART NO.	PIPE THREAD [NPT]	OCTAGON	H	L	M	N	FLOW DIA. D
XV500P-20	1-1/4	1.93	6.22	8.05	3.66	3.01	1.18
XV500P-24	1-1/2	2.13	6.22	8.23	4.02	3.25	1.50
XV500P-32	2	2.69	6.22	8.58	4.76	3.52	1.89

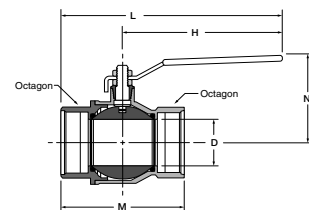

Vented, Female Pipe Ends XVV500P

PART NO.	PIPE THREAD	B HEX	C HEX	K	H	L	M	N	D FLOW Ø
XVV500P-4	1/4	15/16	15/16	1.11	3.96	4.90	2.03	2.47	.375
XVV500P-6	3/8	15/16	15/16	1.11	3.96	4.90	2.03	2.47	.375
XVV500P-8	1/2*	1-1/16	1-1/16	1.23	3.96	5.00	2.20	2.58	.500
XVV500P-12	3/4**	1-1/4	1-5/16	1.45	3.96	5.25	2.42	2.81	.685
XVV500P-16	1**	1-1/2	1-9/16	1.58	3.96	5.34	2.75	3.08	.875

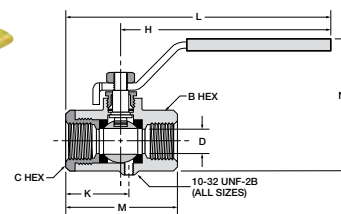

Locking Handle, Female Pipe Ends XVP500P

PART NO.	PIPE THREAD	B HEX	C HEX	H	L	M	N	D FLOW Ø
XVP500P-4	1/4	15/16	15/16	3.96	4.90	2.03	2.47	.375
XVP500P-6	3/8	15/16	15/16	3.96	4.90	2.03	2.47	.375
XVP500P-8	1/2*	1-1/16	1-1/16	3.96	5.00	2.20	2.58	.500
XVP500P-12	3/4**	1-1/4	1-5/16	3.96	5.25	2.42	2.81	.685
XVP500P-16	1**	1-1/2	1-9/16	3.96	5.34	2.75	3.08	.875
FOR USE WITH 5/16" Ø SHANK LOCK, .330								
XVP500P-20	1-1/4	1-15/16	1-15/16	6.22	8.05	3.66	4.04	1.180
XVP500P-24	1-1/2	2-1/8	2-1/8	6.22	8.23	4.02	4.52	1.500
XVP500P-32	2	2-11/16	2-11/16	6.22	8.60	4.76	5.07	1.890
FOR USE WITH 9/32" Ø SHANK LOCK, .310								

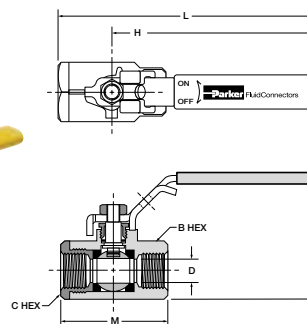

OSHA 29 CFR Part 1910 Vented, Locking Handle, Female Pipe Ends XVVP500P

PART NO.	PIPE THD	B HEX	C HEX	K	H	L	M	N	D FLOW Ø
XVVP500P-4	1/4	15/16	15/16	1.11	3.96	4.90	2.03	2.47	.375
XVVP500P-6	3/8	15/16	15/16	1.11	3.96	4.90	2.03	2.47	.375
XVVP500P-8	1/2*	1-1/16	1-1/16	1.23	3.96	5.00	2.20	2.58	.500
XVVP500P-12	3/4**	1-1/4	1-5/16	1.45	3.96	5.25	2.42	2.81	.685
XVVP500P-16	1**	1-1/2	1-9/16	1.58	3.96	5.34	2.75	3.08	.875
FOR USE WITH 5/16" Ø SHANK LOCK									

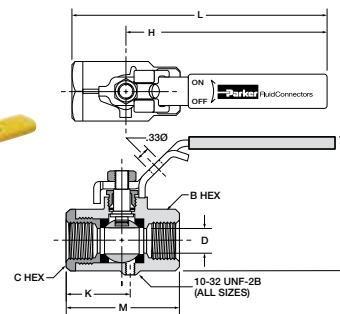

K

*PTF Special Short. **PTF Special Extra Short



Tee Handle, Female Pipe Ends XV500P-X-04

PART NO.	PIPE THREAD	B HEX	C HEX	H	L	M	N	D FLOW Ø
XV500P-4-04	1/4	15/16	15/16	1.25	2.50	2.03	1.87	.375
XV500P-6-04	3/8	15/16	15/16	1.25	2.50	2.03	1.87	.375
XV500P-8-04	1/2*	1-1/16	1-1/16	1.25	2.50	2.20	1.98	.500
XV500P-12-04	3/4**	1-1/4	1-5/16	1.25	2.50	2.42	2.20	.685
XV500P-16-04	1**	1-1/2	1-9/16	1.25	2.50	2.75	2.48	.875

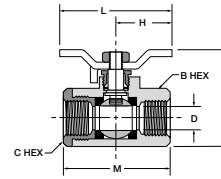

Oval Handle, Female Pipe Ends XV500P-X-21

PART NO.	PIPE THREAD	B HEX	C HEX	H	L	M	N	D FLOW Ø
XV500P-4-21	1/4	15/16	15/16	1.74	3.49	2.03	2.38	.375
XV500P-6-21	3/8	15/16	15/16	1.74	3.49	2.03	2.38	.375
XV500P-8-21	1/2*	1-1/16	1-1/16	1.74	3.49	2.20	2.49	.500
XV500P-12-21	3/4**	1-1/4	1-5/16	1.74	3.48	2.42	2.71	.685
XV500P-16-21	1**	1-1/2	1-9/16	1.74	3.48	2.75	2.99	.875

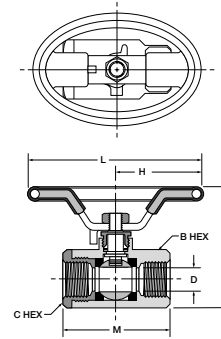

*PTF Special Short. **PTF Special Extra Short



Male /Female Brass Ball Valves Series 501

MATERIALS OF CONSTRUCTION	
VALVE BODY:	FORGED BRASS
BALL:	CHROME PLATED BRASS
SEATS / SEALS:	PTFE
HANDLE:	STEEL

STYLE	TYPE	MATERIAL	SIZE	OPTIONS
V	501	P	-4	-00
STYLE	<ul style="list-style-type: none"> • V-VALVE • VP-VALVE, PADLOCKING HANDLE • VV-VALVE, VENTED • VVP-VALVE, VENTED, PADLOCKING HANDLE 			
TYPE	501-MALE/FEMALE PTF PORTS			
MATERIAL	P- BRASS PN-NICKEL PLATED			
SIZE	4-1/4", 6-3/8", 8-1/2", 12-3/4", 16-1"			
OPTIONS	<ul style="list-style-type: none"> • 01-STAINLESS STEEL BALL & STEM • 02-STAINLESS STEEL HANDLE & NUT • 03-STAINLESS STEEL BALL, STEM, HANDLE & NUT • 04-TEE HANDLE • 08-UNMARKED YELLOW VINYL HANDLE COVER • 21-OVAL HANDLE 			



SPECIFICATIONS	
OPERATING INSTRUCTIONS:	QUARTER TURN IS "ON" OR "OFF". (PROVIDES POSITIVE STOP ACTION FOR FULL SHUTOFF.)
PRESSURE RANGE:	<ul style="list-style-type: none"> • 600 WOG, COLD NON-SHOCK • SATURATED STEAM UP TO 150 PSI • VACUUM SERVICE TO 29 INCHES HG. • VENTED UP TO 250 PSI
TEMPERATURE RANGES:	0° TO +350°F
NOTE:	PERIODICALLY CHECK THE ADJUSTABLE PACKING NUT AND TIGHTEN AS REQUIRED.

Parker's industrial ball valve product line is intended for general purpose use. Please be aware that ball valves are intended for use in the fully open or closed positions. Depending on application conditions, throttling of the valve may result in premature seal failure and/or inability to turn the valve handle.

For use as fuel line shutoffs for gasoline and diesel powered over highway, off highway, and construction equipment vehicles. Water and air service lines on capital equipment and plant design plumbing that require total shutoff capability.

FLOW DATA	
VALVE SIZE	CV
1/4	6.3
3/8	5.7
1/2	10.0
3/4	25.0
1	35.0

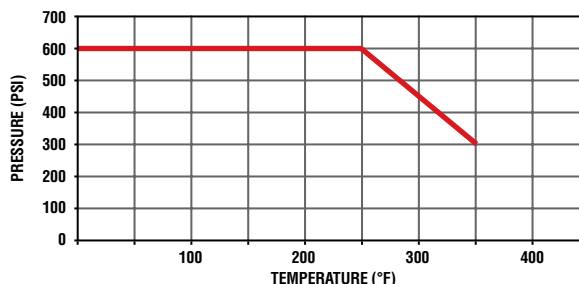

K

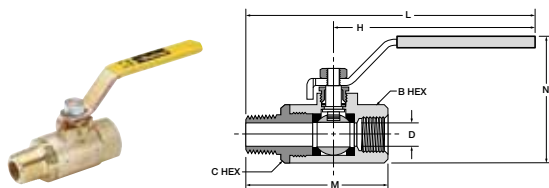

Male-Female Pipe Ends XV501P

PART NO.	FEMALE PIPE THRD [PTF]	MALE PIPE THRD [NPTF]	B HEX	C HEX	H	L	M	N	D FLOW Ø
XV501P-4	1/4	1/4	15/16	15/16	3.96	5.46	2.59	2.47	.344
XV501P-6	3/8	3/8	15/16	15/16	3.96	5.46	2.59	2.47	.375
XV501P-8	1/2*	1/2	1-1/16	1-1/16	3.96	5.75	2.94	2.58	.500
XV501P-12	3/4**	3/4*	1-1/4	1-5/16	3.96	5.83	3.00	2.81	.685
XV501P-16	1**	1*	1-1/2	1-9/16	3.96	6.19	3.60	3.08	.875

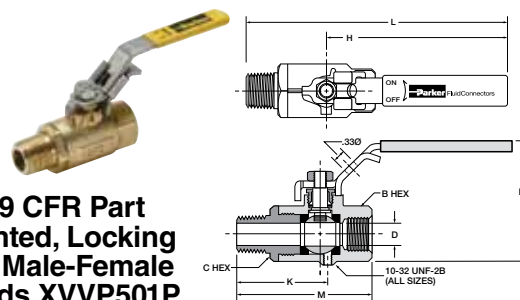

OSHA 29 CFR Part 1910 Vented, Locking Handle, Male-Female Pipe Ends XVVP501P

PART NO.	FEMALE PIPE THRD [PTF]	MALE PIPE THRD [NPTF]	B HEX	C HEX	K	H	L	M	N	D FLOW Ø
XVVP501P-4	1/4	1/4	15/16	15/16	1.67	3.96	5.46	2.59	2.47	.344
XVVP501P-6	3/8	3/8	15/16	15/16	1.67	3.96	5.46	2.59	2.47	.375
XVVP501P-8	1/2*	1/2	1-1/16	1-1/16	1.98	3.96	5.75	2.95	2.58	.500
XVVP501P-12	3/4**	3/4	1-1/4	1-5/16	2.03	3.96	5.83	3.00	2.81	.685
XVVP501P-16	1**	1	1-1/2	1-9/16	2.43	3.96	6.19	3.60	3.08	.875

For use with 5/16" Ø shank lock

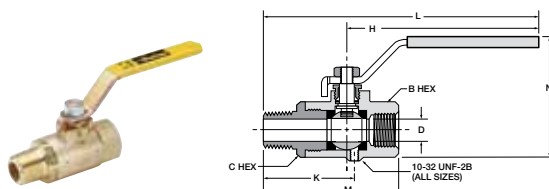

Vented, Male-Female Pipe Ends XVV501P

PART NO.	FEMALE PIPE THRD [PTF]	MALE PIPE THRD [NPTF]	B HEX	C HEX	K	H	L	M	N	D FLOW Ø
XVV501P-4	1/4	1/4	15/16	15/16	1.67	3.96	5.46	2.59	2.47	.344
XVV501P-6	3/8	3/8	15/16	15/16	1.67	3.96	5.46	2.59	2.47	.375
XVV501P-8	1/2*	1/2	1-1/16	1-1/16	1.98	3.96	5.75	2.95	2.58	.500
XVV501P-12	3/4**	3/4*	1-1/4	1-5/16	2.03	3.96	5.83	3.00	2.81	.685
XVV501P-16	1**	1*	1-1/2	1-9/16	2.43	3.96	6.19	3.60	3.08	.875

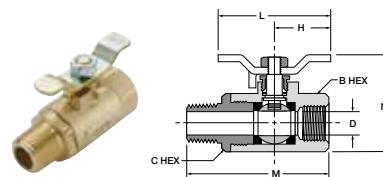

Tee Handle, Male-Female Pipe Ends XV501P-X-04

PART NO.	FEMALE PIPE THRD [PTF]	MALE PIPE THRD [NPTF]	B HEX	C HEX	H	L	M	N	D FLOW Ø
XV501P-4-04	1/4	1/4	15/16	15/16	1.25	2.50	2.59	1.87	.344
XV501P-6-04	3/8	3/8	15/16	15/16	1.25	2.50	2.59	1.87	.375
XV501P-8-04	1/2*	1/2	1-1/16	1-1/16	1.25	2.50	2.95	1.98	.500
XV501P-12-04	3/4**	3/4	1-1/4	1-5/16	1.25	2.50	3.00	2.20	.685
XV501P-16-04	1**	1	1-1/2	1-9/16	1.25	2.50	3.60	2.48	.875

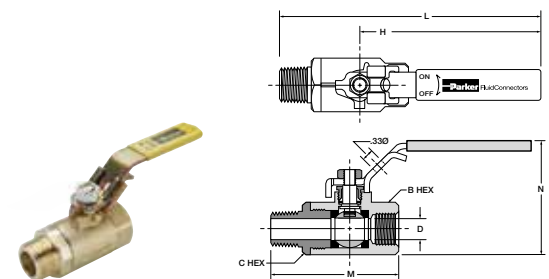

Locking Handle, Male-Female Pipe Ends XVP501P

PART NO.	FEMALE PIPE THRD [PTF]	MALE PIPE THRD [NPTF]	B HEX	C HEX	H	L	M	N	D FLOW Ø
XVP501P-4	1/4	1/4	15/16	15/16	3.96	5.46	2.59	2.47	.344
XVP501P-6	3/8	3/8	15/16	15/16	3.96	5.46	2.59	2.47	.375
XVP501P-8	1/2*	1/2	1-1/16	1-1/16	3.96	5.75	2.95	2.58	.500
XVP501P-12	3/4**	3/4*	1-1/4	1-5/16	3.96	5.83	3.00	2.81	.685
XVP501P-16	1**	1*	1-1/2	1-9/16	3.96	6.19	3.60	3.08	.875

For use with 5/16" Ø shank lock

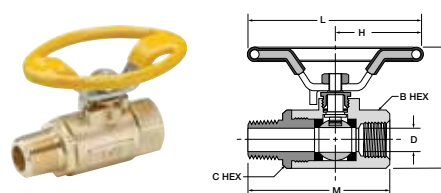

Oval Handle, Male-Female Pipe Ends XV501P-X-21

PART NO.	FEMALE PIPE THRD [PTF]	MALE PIPE THRD [NPTF]	B HEX	C HEX	H	L	M	N	D FLOW Ø
XV501P-4-21	1/4	1/4	15/16	15/16	1.74	3.49	2.59	2.38	.344
XV501P-6-21	3/8	3/8	15/16	15/16	1.74	3.49	2.59	2.38	.375
XV501P-8-21	1/2*	1/2	1-1/16	1-1/16	1.74	3.49	2.95	2.49	.500
XV501P-12-21	3/4**	3/4	1-1/4	1-5/16	1.74	3.48	3.00	2.71	.685
XV501P-16-21	1**	1	1-1/2	1-9/16	1.74	3.48	3.60	2.99	.875

*PTF Special Short. **PTF Special Extra Short





Panel Mount Ball Valves Series 502

MATERIALS OF CONSTRUCTION	
VALVE BODY:	FORGED BRASS
BALL:	CHROME PLATED BRASS
SEATS / SEALS:	PTFE
HANDLE:	STEEL

STYLE	TYPE	MATERIAL	SIZE	OPTIONS
V	502	P	-4	-00
STYLE	<ul style="list-style-type: none"> • V-VALVE • VP-VALVE, PADLOCKING HANDLE • VV-VALVE, VENTED • VVP-VALVE, VENTED, PADLOCKING HANDLE 			
TYPE	502-FEMALE/FEMALE PTF PORTS			
MATERIAL	P- BRASS PN-NICKEL PLATED			
SIZE	4-1/4", 6-3/8", 8-1/2", 12-3/4", 16-1"			
OPTIONS	<ul style="list-style-type: none"> • 01-STAINLESS STEEL BALL & STEM • 02-STAINLESS STEEL HANDLE & NUT • 03-STAINLESS STEEL BALL, STEM, HANDLE & NUT • 04-TEE HANDLE • 08-UNMARKED YELLOW VINYL HANDLE COVER • 21-OVAL HANDLE 			



SPECIFICATIONS	
OPERATING INSTRUCTIONS:	QUARTER TURN IS "ON" OR "OFF". (PROVIDES POSITIVE STOP ACTION FOR FULL SHUTOFF.)
PRESSURE RANGE:	<ul style="list-style-type: none"> • 600 WOG, COLD NON-SHOCK • SATURATED STEAM UP TO 150 PSI • VACUUM SERVICE TO 29 INCHES HG. • VENTED UP TO 250 PSI
TEMPERATURE RANGES:	0° TO +350°F
NOTE:	PERIODICALLY CHECK THE ADJUSTABLE PACKING NUT AND TIGHTEN AS REQUIRED.

Parker's industrial ball valve product line is intended for general purpose use. Please be aware that ball valves are intended for use in the fully open or closed positions. Depending on application conditions, throttling of the valve may result in premature seal failure and/or inability to turn the valve handle.

For use as fuel line shutoffs for gasoline and diesel powered over the highway, off highway, and construction equipment vehicles. Water and air service lines on capital equipment and plant design plumbing that require total shutoff capability.

FLOW DATA	
VALVE SIZE	CV
1/4	4.0
3/8	5.8
1/2	12.0
3/4	25.0
1	35.0

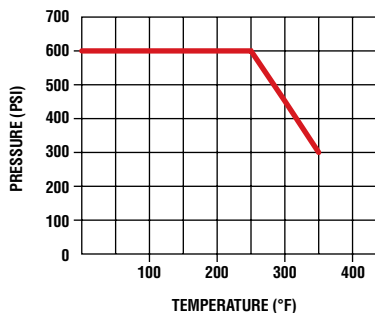

Mounting detail for all sizes

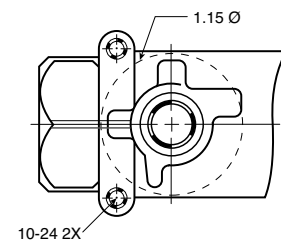

K

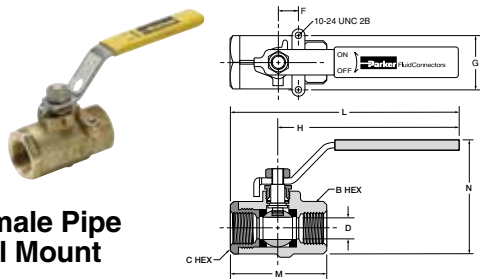

Female-Female Pipe Ends, Panel Mount XV502P

PART NO.	PIPE THD.	B HEX	C HEX	F	G	H	L	M	N	FLOW DIA. D
XV502P-4	1/4	15/16	15/16	.50	1.12	3.96	4.90	2.03	2.47	.375
XV502P-6	3/8	15/16	15/16	.50	1.12	3.96	4.90	2.03	2.47	.375
XV502P-8	1/2*	1-1/16	1-1/16	.50	1.12	3.96	5.00	2.20	2.58	.500
XV502P-12	3/4**	1-1/4	1-5/16	.87	1.37	3.96	5.25	2.42	2.81	.685
XV502P-16	1**	1-1/2	1-9/16	.87	1.37	3.96	5.34	2.75	3.08	.875

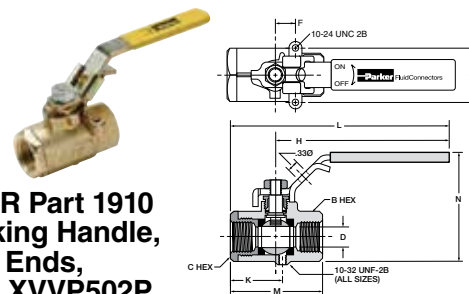

OSHA 29 CFR Part 1910 Vented, Locking Handle, Female Pipe Ends, Panel Mount XVVP502P

PART NO.	PIPE THD.	B HEX	C HEX	F	G	K	H	L	M	N	D FLOW Ø
XVVP502P-4	1/4	15/16	15/16	.50	1.12	1.11	3.96	4.90	2.03	2.47	.375
XVVP502P-6	3/8	15/16	15/16	.50	1.12	1.11	3.96	4.90	2.03	2.47	.375
XVVP502P-8	1/2*	1-1/16	1-1/16	.50	1.12	1.23	3.96	5.00	2.20	2.58	.500
XVVP502P-12	3/4**	1-1/4	1-5/16	.87	1.37	1.45	3.96	5.25	2.42	2.81	.685
XVVP502P-16	1**	1-1/2	1-9/16	.87	1.37	1.58	3.96	5.34	2.75	3.08	.875

For use with 5/16" Ø shank lock

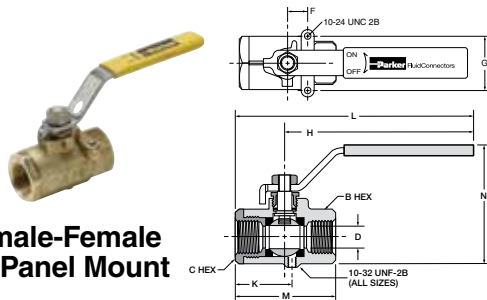

Vented, Female-Female Pipe Ends, Panel Mount XVV502P

PART NO.	PIPE THD.	B HEX	C HEX	F	G	K	H	L	M	N	D FLOW Ø
XVV502P-4	1/4	15/16	15/16	.50	1.12	1.11	3.96	4.90	2.03	2.47	.375
XVV502P-6	3/8	15/16	15/16	.50	1.12	1.11	3.96	4.90	2.03	2.47	.375
XVV502P-8	1/2*	1-1/16	1-1/16	.50	1.12	1.23	3.96	5.00	2.20	2.58	.500
XVV502P-12	3/4**	1-1/4	1-5/16	.87	1.37	1.45	3.96	5.25	2.42	2.81	.685
XVV502P-16	1**	1-1/2	1-9/16	.87	1.37	1.58	3.96	5.34	2.75	3.08	.875

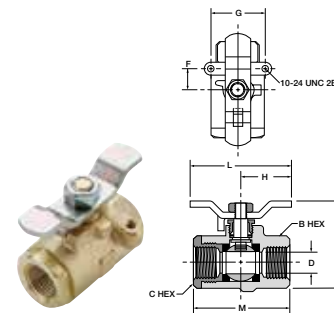

Tee Handle, Female Pipe Ends, Panel Mount XV502P-X-04

PART NO.	PIPE THD.	B HEX	C HEX	F	G	H	L	M	N	D FLOW Ø
XV502P-4-04	1/4	15/16	15/16	.50	1.12	1.25	2.50	2.03	1.87	.375
XV502P-6-04	3/8	15/16	15/16	.50	1.12	1.25	2.50	2.03	1.87	.375
XV502P-8-04	1/2*	1-1/16	1-1/16	.50	1.12	1.25	2.50	2.20	1.98	.500
XV502P-12-04	3/4**	1-1/4	1-5/16	.87	1.37	1.25	2.50	2.42	2.20	.685
XV502P-16-04	1**	1-1/2	1-9/16	.87	1.37	1.25	2.50	2.75	2.48	.875

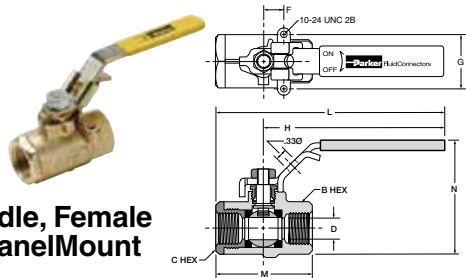

Locking Handle, Female Pipe Ends, Panel Mount XVP502P

PART NO.	PIPE THD.	B HEX	C HEX	F	G	H	L	M	N	D FLOW Ø
XVP502P-4	1/4	15/16	15/16	.50	1.12	3.96	4.90	2.03	2.47	.375
XVP502P-6	3/8	15/16	15/16	.50	1.12	3.96	4.90	2.03	2.47	.375
XVP502P-8	1/2*	1-1/16	1-1/16	.50	1.12	3.96	5.00	2.20	2.58	.500
XVP502P-12	3/4**	1-1/4	1-5/16	.87	1.37	3.96	5.25	2.42	2.81	.685
XVP502P-16	1**	1-1/2	1-9/16	.87	1.37	3.96	5.34	2.75	3.08	.875

For use with 5/16" Ø shank lock

*PTF Special Short. **PTF Special Extra Short

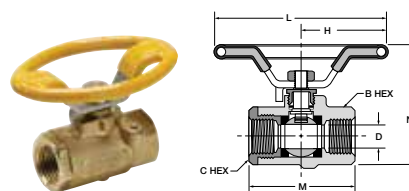

Oval Handle, Female Pipe Ends, Panel Mount XV502P-X-21

PART NO.	PIPE THD.	B HEX	C HEX	H	L	M	N	D FLOW Ø
XV502P-4-21	1/4	15/16	15/16	1.74	3.49	2.03	2.38	.375
XV502P-6-21	3/8	15/16	15/16	1.74	3.49	2.03	2.38	.375
XV502P-8-21	1/2*	1-1/16	1-1/16	1.74	3.49	2.20	2.49	.500
XV502P-12-21	3/4**	1-1/4	1-5/16	1.74	3.48	2.42	2.71	.685
XV502P-16-21	1**	1-1/2	1-9/16	1.74	3.48	2.75	2.99	.875





Female/Female Straight Thread Brass Ball Valve Series 506

MATERIALS OF CONSTRUCTION	
VALVE BODY:	FORGED BRASS
BALL:	CHROME PLATED BRASS
SEATS / SEALS:	PTFE
HANDLE:	STEEL

STYLE	TYPE	MATERIAL	SIZE	OPTIONS
V	506	P	-4	-00
STYLE	<ul style="list-style-type: none"> V-VALVE VP-VALVE, PADLOCKING HANDLE 			
TYPE	506 FEMALE/FEMALE SAE J1926-1 PORTS			
MATERIAL	P- BRASS			
SIZE	4-1/4", 6-3/8", 8-1/2", 12-3/4", 16-1", 20-1 1/4", 24-1 1/2", 32-2"			
OPTIONS	<ul style="list-style-type: none"> 01-STAINLESS STEEL BALL & STEM 02-STAINLESS STEEL HANDLE & NUT* 03-STAINLESS STEEL BALL, STEM, HANDLE & NUT 04-TEE HANDLE* 08-UNMARKED YELLOW VINYL HANDLE COVER* 21-OVAL HANDLE 			



SPECIFICATIONS	
PRESSURE RANGE:	<ul style="list-style-type: none"> 600 WOG, COLD NON-SHOCK SATURATED STEAM UP TO 150 PSI VACUUM SERVICE TO 29 INCHES HG.
TEMPERATURE RANGES:	0° TO +350°F
OPERATING INSTRUCTIONS	QUARTER TURN IS "ON" OR "OFF". (PROVIDES POSITIVE STOP ACTION FOR FULL SHUTOFF.)
NOTE:	PERIODICALLY CHECK THE ADJUSTABLE PACKING NUT AND TIGHTEN AS REQUIRED.

Parker's industrial ball valve product line is intended for general purpose use. Please be aware that ball valves are intended for use in the fully open or closed positions. Depending on application conditions, throttling of the valve may result in premature seal failure and/or inability to turn the valve handle.

For use on construction equipment, chemical processing, plastic and rubber manufacturing, pumps and specialized industrial machinery requiring total shut-off capability.

FLOW DATA	
VALVE SIZE	CV
1/4	4.0
3/8	5.8
1/2	12.0
3/4	25.0
1	35.0
1-1/4"	57.0
1-1/2"	92.0
2"	224.0

*For these part numbers only the * options are available.

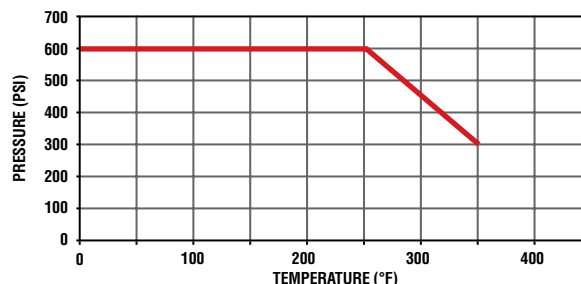

Female/Female, Straight Thread O-Ring Port XV506P

PART NO.	STRT. THREAD	B HEX	C HEX	H	L	M	N	D FLOW Ø
XV506P-4	7/16-20	15/16	15/16	3.96	5.01	2.20	2.47	.375
XV506P-6	9/16-18	15/16	15/16	3.96	5.07	2.26	2.47	.375
XV506P-8	3/4-16	1-1/16	1-1/16	3.96	5.18	2.42	2.60	.500
XV506P-12	1-1/16-12	1-1/4	1-5/16	3.96	5.87	3.46	2.81	.685
XV506P-16	1-5/16-12	1-1/2	1-9/16	3.96	5.96	3.68	3.08	.875

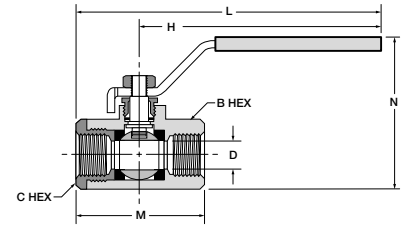

Female/Female, Straight Thread O-Ring Port XV506P-20, XV506P-24, XV506P-32

PART NO.	STRT. THREAD	B OCT	C OCT	H	L	M	N	D FLOW Ø
XV506P-20	1 5/8-12	1.93	1.93	6.22	8.05	3.66	3.01	1.18
XV506P-24	1 7/8-12	2.13	2.13	6.22	8.23	4.02	3.25	1.50
XV506P-32	2 1/2-12	2.85	2.85	6.22	8.60	4.76	3.52	1.89

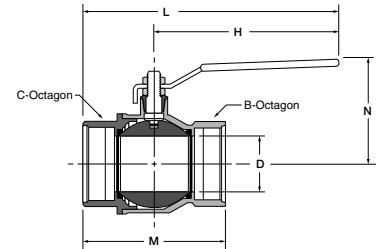



Solder End Ball Valves Series 509

MATERIALS OF CONSTRUCTION	
VALVE BODY:	FORGED BRASS
BALL:	CHROME PLATED BRASS
SEATS / SEALS:	PTFE
HANDLE:	STEEL

PRESSURE AND TEMPERATURE RANGE	
PRESSURE RANGE	600 WOG, COLD NON-SHOCK SATURATED STEAM UP TO 150 PSI
TEMPERATURE RANGE	0° TO +350°F SOLDER TEMPERATURE NOT TO EXCEED 470°F

STYLE	TYPE	MATERIAL	SIZE
V	509	P	-4
STYLE	V-VALVE		
TYPE	509-SOLDER ENDS		
MATERIAL	P-BRASS		
SIZE	8-1/2", 12-3/4", 16-1", 20-1 1/4", 24-1 1/2", 32-2"		

JOINING MATERIAL	MELTING RANGE °F	WORKING TEMP. °F	MAX. WORKING PRESSURE (PSI)	
			SIZE 1/2 - 1"	SIZE 1-1/4" - 2"
50-50 TIN-LEAD SOLDER	361-421	100	200	175
		150	150	125
		200	100	90
		250	85	75
95-5 TIN ANTIMONY SOLDER	450-464	100	400	400
		150	400	350
		200	300	250
		250	200	175

SPECIFICATIONS	
OPERATING INSTRUCTIONS	QUARTER TURN IS "ON" OR "OFF" (PROVIDES POSITIVE STOP ACTION FOR FULL SHUTOFF.)



Parker's industrial ball valve product line is intended for general purpose use. Please be aware that ball valves are intended for use in the fully open or closed positions. Depending on application conditions, throttling of the valve may result in premature seal failure and/or inability to turn the valve handle.

These valves are ideal for water and air service lines on capital equipment and plant design plumbing that require total shut-off capability. Use with ASTM B88 copper water tubing.

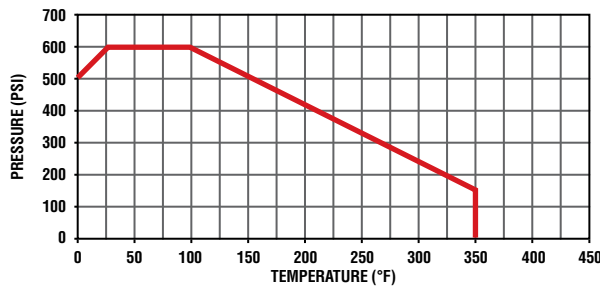

FLOW DATA	
VALVE SIZE	CV
1/2"	26
3/4"	69
1"	91
1 1/4"	127
1 1/2"	299
2"	425

Solder Cup Ends XV509P

PART NO.	TUBE SIZE	E	G	H	L	M	N	FLOW DIA. D
XV509P-8	1/2	.630	.49	3.94	5.00	2.24	1.69	.55
XV509P-12	3/4	.877	.75	4.72	6.10	2.85	1.97	.75
XV509P-16	1	1.128	.90	4.72	6.40	3.35	2.13	.94
XV509P-20	1 1/4	1.378	.96	6.22	8.13	3.82	3.01	1.18
XV509P-24	1 1/2	1.628	1.10	6.22	8.46	4.49	3.25	1.50
XV509P-32	2	2.128	1.34	6.22	8.94	5.43	3.52	1.89

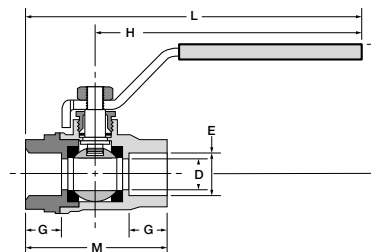



Male/Female Straight Thread Ball Valves Series 510

MATERIALS OF CONSTRUCTION	
VALVE BODY:	FORGED BRASS
BALL:	CHROME PLATED BRASS
SEATS / SEALS:	PTFE
HANDLE:	STEEL

STYLE	TYPE	MATERIAL	SIZE	OPTIONS
V	510	P	-4	-00
STYLE	<ul style="list-style-type: none"> • V-VALVE • VP-VALVE, PADLOCKING HANDLE 			
TYPE	510 MALE/FEMALE STRAIGHT THREAD O-RING SAE J1926			
MATERIAL	P- BRASS			
SIZE	4-1/4", 6-3/8", 8-1/2", 12-3/4", 16-1"			
OPTIONS	<ul style="list-style-type: none"> • 01-STAINLESS STEEL BALL & STEM • 02-STAINLESS STEEL HANDLE & NUT • 03-STAINLESS STEEL BALL, STEM, HANDLE & NUT • 04-TEE HANDLE • 08-UNMARKED YELLOW VINYL HANDLE COVER • 21-OVAL HANDLE 			



SPECIFICATIONS	
PRESSURE RANGE:	<ul style="list-style-type: none"> • 600 WOG, COLD NON-SHOCK • SATURATED STEAM UP TO 150 PSI • VACUUM SERVICE TO 29 INCHES HG. • VENTED UP TO 250 PSI
TEMPERATURE RANGES:	0° TO +350°F
OPERATING INSTRUCTIONS	QUARTER TURN IS "ON" OR "OFF". (PROVIDES POSITIVE STOP ACTION FOR FULL SHUTOFF.)
NOTE:	PERIODICALLY CHECK THE ADJUSTABLE PACKING NUT AND TIGHTEN AS REQUIRED.

FLOW DATA	
VALVE SIZE	CV
1/4	.8
3/8	2.1
1/2	5.3
5/8	7.6
3/4	13.0
1	33.0

Parker's industrial ball valve product line is intended for general purpose use. Please be aware that ball valves are intended for use in the fully open or closed positions. Depending on application conditions, throttling of the valve may result in premature seal failure and/or inability to turn the valve handle.

For use on construction equipment, chemical processing, plastic and rubber manufacturing, pumps and specialized industrial machinery requiring total shut-off capability.

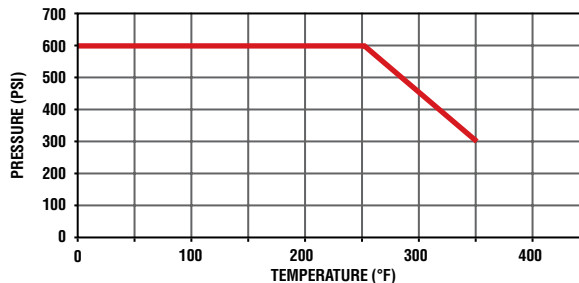

Male-Female, Straight Thread O-Ring Port XV510P

PART NO.	STRT. THREAD	B HEX	C HEX	H	L	M	N	D FLOW Ø
XV510P-4	7/16-20	15/16	15/16	3.96	5.61	2.85	2.47	.188
XV510P-6	9/16-18	15/16	15/16	3.96	5.68	2.92	2.47	.281
XV510P-8	3/4-16	1-1/16	1-1/16	3.96	5.88	3.17	2.58	.422
XV510P-10	7/8-14	1-1/4	1-5/16	3.96	6.31	3.90	2.81	.500
XV510P-12	1-1/16-12	1-1/4	1-5/16	3.96	6.44	4.03	2.81	.656
XV510P-16	1-5/16-12	1-1/2	1-9/16	3.96	6.56	4.28	3.08	.875

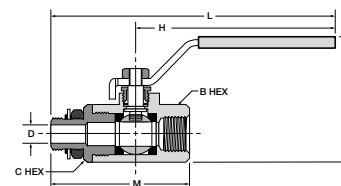

Locking Handle, Straight Thread O-Ring Port XVP510P

PART NO.	STRT. THREAD	B HEX	C HEX	H	L	M	N	D FLOW Ø
XVP510P-4	7/16-20	15/16	15/16	3.96	5.61	2.85	2.47	.188
XVP510P-6	9/16-18	15/16	15/16	3.96	5.68	2.92	2.47	.281
XVP510P-8	3/4-16	1-1/16	1-1/16	3.96	5.88	3.17	2.58	.422
XVP510P-10	7/8-14	1-1/4	1-5/16	3.96	6.31	3.90	2.81	.500
XVP510P-12	1-1/16-12	1-1/4	1-5/16	3.96	6.44	4.03	2.81	.656

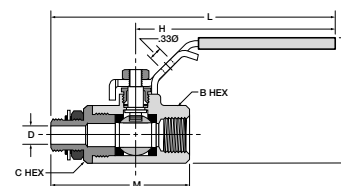

For use with 5/16" Ø shank lock

Tee Handle, Straight Thread O-Ring Port XV510P-X-04

PART NO.	STRT. THREAD	B HEX	C HEX	H	L	M	N	D FLOW Ø
XV510P-4-04	7/16-20	15/16	15/16	1.25	2.50	2.85	1.87	.188
XV510P-6-04	9/16-18	15/16	15/16	1.25	2.50	2.92	1.87	.281
XV510P-8-04	3/4-16	1-1/16	1-1/16	1.25	2.50	3.17	1.98	.422
XV510P-10-04	7/8-14	1-1/4	1-5/16	1.25	2.50	3.90	2.20	.500
XV510P-12-04	1-1/16-12	1-1/4	1-5/16	1.25	2.50	4.03	2.20	.656
XV510P-16-04	1-5/16-12	1-1/2	1-9/16	1.25	2.50	4.28	2.48	.875

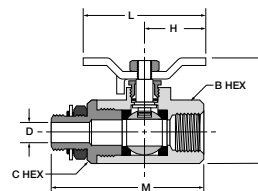

K

Oval Handle, Straight Thread O-Ring Port XV510P-X-21

PART NO.	STRT. THREAD	B & C HEX	H	L	M	N	D FLOW Ø
XV510P-4-21	7/16-20	15/16	1.74	3.49	2.85	2.38	.188
XV510P-6-21	9/16-18	15/16	1.74	3.49	2.92	2.38	.281
XV510P-8-21	3/4-16	1 1/16	1.74	3.49	3.17	2.49	.422
XV510P-12-21	1-1/16-12	1-1/4 (B)	1.75	3.49	4.03	2.71	.656
		1-5/16 (C)					

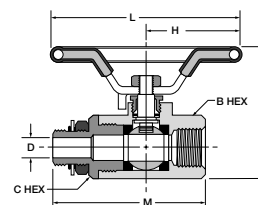



Brass Ball Valves Series 520

MATERIALS OF CONSTRUCTION	
VALVE BODY:	FORGED BRASS
BALL:	CHROME PLATED BRASS
SEATS / SEALS:	PTFE
STEM O-RINGS:	VITON
HANDLE:	STEEL

STYLE	TYPE	MATERIAL	SIZE	OPTIONS
V	520	P	-4	-00
STYLE	V-VALVE			
TYPE	520-FEMALE/FEMALE NPT PORTS			
MATERIAL	P- BRASS			
SIZE	4-1/4", 6-3/8", 8-1/2", 12-3/4", 16-1", 20-1 1/4", 24-1 1/2", 32-2"			
OPTIONS	04-TEE HANDLE			



SPECIFICATIONS	
OPERATING INSTRUCTIONS:	QUARTER TURN IS "ON" OR "OFF". (PROVIDES POSITIVE STOP ACTION FOR FULL SHUTOFF.)
PRESSURE RANGE:	<ul style="list-style-type: none"> • 600 WOG, COLD NON-SHOCK – SIZES 1/4" – 2" • 450 WOG, COLD NON-SHOCK – SIZES 2 1/2" – 3" • SATURATED STEAM UP TO 150 PSI • VACUUM SERVICE TO 29 INCHES HG.
TEMPERATURE RANGES:	0° TO +350°F
NOTE:	PERIODICALLY CHECK THE ADJUSTABLE PACKING NUT AND TIGHTEN AS REQUIRED.

Parker's industrial ball valve product line is intended for general purpose use. Please be aware that ball valves are intended for use in the fully open or closed positions. Depending on application conditions, throttling of the valve may result in premature seal failure and/or inability to turn the valve handle. For use as shutoffs for highway, off highway, and construction equipment vehicles. Water and air service lines on capital equipment and plant design plumbing that require total shutoff capability.

U. L. LISTED	
CATEGORY	
YSDT	LP-GAS SHUT-OFF VALVES
YRBX	FLAMMABLE LIQUID SHUT-OFF VALVES
YRPV	GAS SHUT-OFF VALVES
YQNZ	COMPRESSED GAS SHUT-OFF VALVES

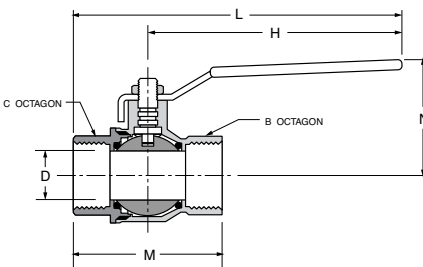
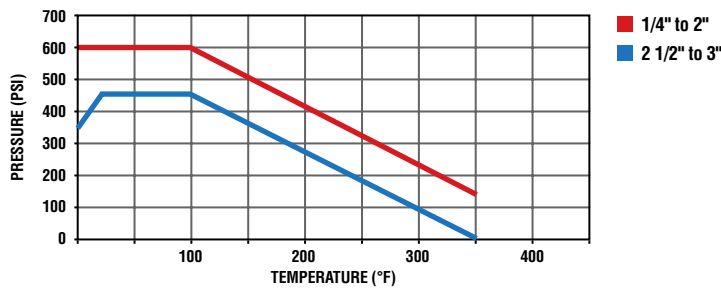

Brass Ball Valve XV520P

PART NO.	PIPE THREAD	B OCTAGON	C OCTAGON	H	L	M	N	D FLOW Ø
XV520P-4	1/4-18	.79	.79	3.94	4.83	1.77	1.50	.310
XV520P-6	3/8-18	.79	.79	3.94	4.83	1.77	1.50	.400
XV520P-8	1/2-14	.98	.98	3.94	5.10	2.32	1.69	.600
XV520P-12	3/4-14	1.22	1.22	4.72	5.98	2.52	1.97	.790
XV520P-16	1-11.5	1.57	1.57	4.72	6.32	3.19	2.13	1.000
XV520P-20	1-1/4	1.93	1.93	6.22	8.05	3.66	2.82	1.250
XV520P-24	1-1/2	2.13	2.13	6.22	8.23	4.02	3.06	1.570
XV520P-32	2	2.69	2.69	6.22	8.58	4.76	3.33	2.000
XV520P-40	2-1/2	3.35	3.35	10.04	13.11	6.14	5.20	2.520
XV520P-48	3	3.89	3.89	10.04	13.52	6.97	5.51	3.000





Brass Ball Valves Series 533 3-Way Diversion / Series 540 4-Way

MATERIALS OF CONSTRUCTION	
VALVE BODY:	FORGED BRASS
BALL:	CHROME PLATED BRASS
SEATS / SEALS:	PTFE
HANDLE:	STEEL

STYLE	TYPE	MATERIAL	SIZE	OPTIONS
V	533	P	-4	-00
STYLE	V-VALVE P-LOCK			
TYPE	533 3-WAY DIVERSION, 540 4-WAY			
MATERIAL	P- BRASS			
SIZE	4-1/4", 6-3/8", 8-1/2", 12-3/4", 16-1"			
OPTIONS	<ul style="list-style-type: none"> • 02-STAINLESS STEEL HANDLE & NUT • 08-UNMARKED YELLOW VINYL HANDLE COVER 			

SPECIFICATIONS	
PRESSURE RANGE:	<ul style="list-style-type: none"> • 400 PSI • VACUUM SERVICE TO 29 INCHES HG.
TEMPERATURE RANGES:	-20° F TO 350°F
NOTE:	DIVERSION VALVES DO NOT HAVE OFF POSITIONS. THEREFORE, THE CENTER PORT CAN NOT BE USED FOR SHUT-OFF PURPOSES.
NOTE:	PERIODICALLY CHECK THE ADJUSTABLE PACKING NUT AND TIGHTEN AS REQUIRED.

XV540P FLOW INFORMATION	
POINTER OVER	FLOW PATH
A	A TO E
OFF	CLOSED
C	C TO E
D	D TO E



Designed for applications requiring flow diversion making tank selection and fluid transfer easy. For use on construction equipment, chemical processing, pumps and specialized industrial machinery.

NOTE: 3-way diversion valves do not have off positions, therefore, the center port can not be used for shut-off purposes.

XV540P Handle Positions

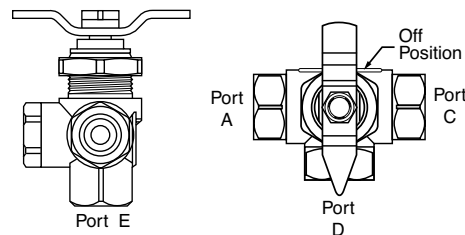

XV533P Handle Positions

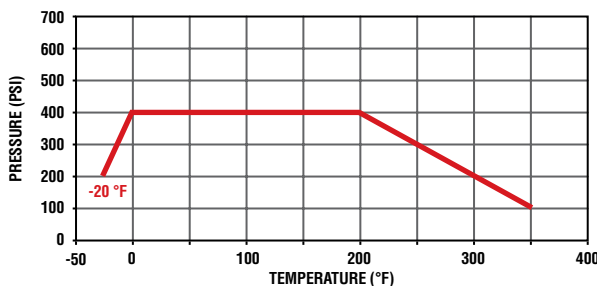
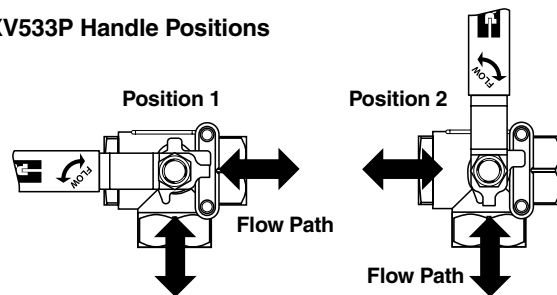

K

Female-Female-Female Pipe Ends XV533P

PART NO.	PIPE THD (PTF)	B HEX	E	F	G	H	K	L	M	N	FLOW DIA. D
XV533P-4	1/4	15/16	.50	1.08	1.12	3.96	1.03	2.47	2.03	1.94	.375
XV533P-6	3/8	15/16	.50	1.08	1.12	3.96	1.03	2.47	2.03	1.94	.375
XV533P-8	1/2	1-1/16	.50	1.18	1.12	3.96	1.11	2.58	2.20	1.98	.500
XV533P-12	3/4	1-1/4	.87	1.43	1.37	3.96	1.42	2.90	2.83	2.17	.685
XV533P-16	1	1-9/16	.87	1.62	1.37	3.96	1.58	3.21	3.16	2.32	.875

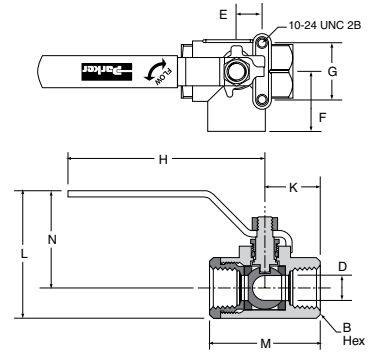

Female-Female-Female-Female Pipe Ends XV540P

PART NO.	PIPE THD (PTF)	B HEX	E	F	G	H	K	L	M	N	FLOW DIA. D
XV540P-4	1/4	7/8	.32	1.00	1.76	1.25	1.98	2.49	.52	1.07	.250

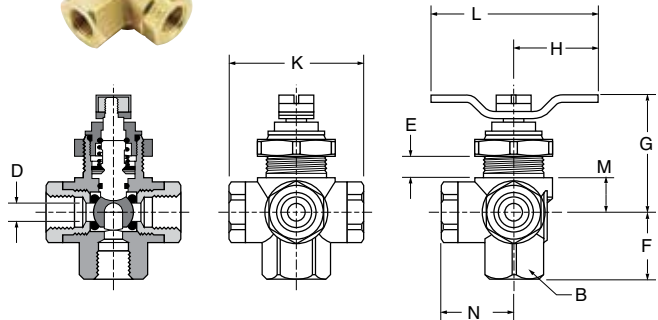



90° Ball Valves Series 590/591

MATERIALS OF CONSTRUCTION	
VALVE BODY:	FORGED BRASS
BALL:	CHROME PLATED BRASS
SEATS / SEALS:	PTFE
HANDLE:	STEEL

STYLE	TYPE	MATERIAL	SIZE	OPTIONS
V	590	P	-8	-00
STYLE	V-VALVE			
TYPE	590-90 MALE/FEMALE 591-90 MALE/MALE			
MATERIAL	P- BRASS			
SIZE	4-1/4", 6-3/8", 8-1/2"			
OPTIONS	<ul style="list-style-type: none"> • 04-LEVER HANDLE • 08-UNMARKED YELLOW VINYL HANDLE COVER 			

SPECIFICATIONS	
PRESSURE RANGE:	<ul style="list-style-type: none"> • 250 PSI • SATURATED STEAM UP TO 150 PSI • VACUUM SERVICE TO 29 INCHES HG.
TEMPERATURE RANGES:	-50°F TO 350°F
OPERATING INSTRUCTIONS	QUARTER TURN IS "ON" OR "OFF". (PROVIDES POSITIVE STOP ACTION FOR FULL SHUT-OFF.)
NOTE:	PERIODICALLY CHECK THE ADJUSTABLE PACKING NUT AND TIGHTEN AS REQUIRED.



Note: 90° Ball Valve Series 590/591 has a tee handle as standard. A Lever Handle is available as option 04.

Parker's industrial ball valve product line is intended for general purpose use. Please be aware that ball valves are intended for use in the fully open or closed positions. Depending on application conditions, throttling of the valve may result in premature seal failure and/or inability to turn the valve handle.

For use as fuel line shutoffs for gasoline and diesel powered over the highway, off highway and construction equipment vehicles. Water and air service lines on capital equipment and plant design plumbing that require total shut-off capability.

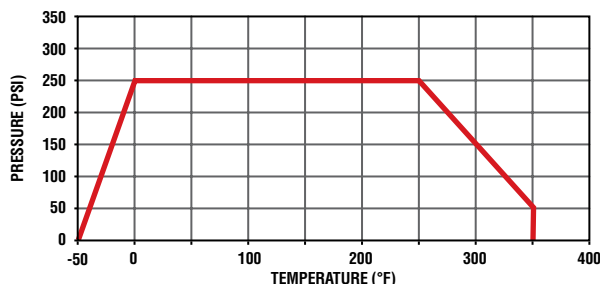

K

90° Flow, Male-Female Pipe Ends XV590P

PART NO.	PIPE PTF THREAD	HEX	H	K	L	M	N	D FLOW Ø
XV590P-4	1/4	15/16	1.25	1.08	2.50	1.00	2.42	.375
XV590P-6	3/8	15/16	1.25	1.09	2.50	1.00	2.43	.375
XV590P-8	1/2*	1-1/16	1.25	1.30	2.50	1.08	2.67	.500
XV590P-16	1**	1-9/16"	1.30	1.90	2.60	1.38	3.62	.750

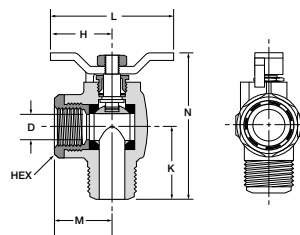

Lever Handle, 90° Flow, Male-Female Pipe Ends XV590P-X-04

PART NO.	PIPE PTF THREAD	HEX	H	K	L	M	N	D FLOW Ø
XV590P-4-04	1/4	15/16	3.96	1.08	4.96	1.00	3.02	.375
XV590P-6-04	3/8	15/16	3.96	1.09	4.96	1.00	3.03	.375
XV590P-8-04	1/2*	1-1/16	3.80	1.30	4.88	1.08	2.95	.500
XV590P-16-04	1**	1-9/16"	3.96	1.90	5.34	1.38	4.17	.750

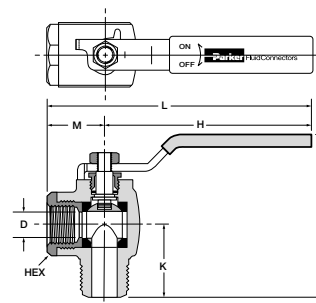

90° Flow, Male-Male Pipe Ends XV591P

PART NO.	PIPE THREAD	HEX	H	K	L	M	N	D FLOW Ø
XV591P-4	1/4	15/16	1.25	1.08	2.50	1.56	2.42	.375
XV591P-6	3/8	15/16	1.25	1.09	2.50	1.56	2.43	.375
XV591P-8	1/2	1-1/16	1.25	1.30	2.50	1.84	2.67	.500

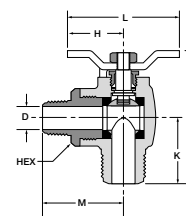

Lever Handle, 90° Flow, Male-Male Pipe Ends XV591P-X-04

PART NO.	PIPE THREAD	HEX	H	K	L	M	N	D FLOW Ø
XV591P-4-04	1/4	15/16	3.96	1.08	5.52	1.56	3.02	.375
XV591P-6-04	3/8	15/16	3.96	1.09	5.52	1.56	3.03	.375
XV591P-8-04	1/2	1-1/16	3.80	1.30	5.64	1.84	2.95	.500

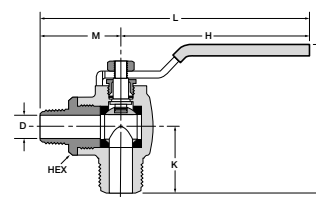

*PTF Special Short. **PTF SPL Extra Short



Brass Hose Barb Ball Valves Series 500HB

MATERIALS OF CONSTRUCTION	
VALVE BODY:	FORGED BRASS
BALL:	CHROME PLATED BRASS
SEATS / SEALS:	PTFE
HANDLE:	STEEL

SPECIFICATIONS	
PRESSURE RANGE:	<ul style="list-style-type: none"> • 150 PSI WOG, COLD NON-SHOCK • SATURATED STEAM UP TO 150 PSI • VACUUM SERVICE TO 29 INCHES HG.
TEMPERATURE RANGES:	0° TO +350°F
OPERATING INSTRUCTIONS	QUARTER TURN IS "ON" OR "OFF" (PROVIDES POSITIVE STOP ACTION FOR FULL SHUTOFF.)
NOTE:	PERIODICALLY CHECK THE ADJUSTABLE PACKING NUT AND TIGHTEN AS REQUIRED.



Parker's industrial ball valve product line is intended for general purpose use. Please be aware that ball valves are intended for use in the fully open or closed positions. Depending on application conditions, throttling of the valve may result in premature seal failure and/or inability to turn the valve handle. For use on construction equipment, chemical processing, plastic and rubber manufacturing, pumps, power units, and specialized industrial machinery requiring total shut-off capability.

K

Brass Hose Barb Ball Valve XV500P-HB

PART NO.	PORT 1	PORT 2 PTF	B HEX	C HEX	H	L	M	N	FLOW DIA. D
XV500P-12-16HB	1	3/4*	1-1/4	1-5/16	3.96	6.25	3.41	2.81	.685

*PTF special extra short

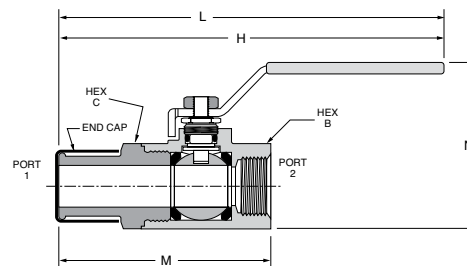



Brass Ball Valves Series 600 Six Port Diversion

MATERIALS OF CONSTRUCTION	
VALVE BODY:	FORGED BRASS
BALL:	CHROME PLATED BRASS
SEATS / SEALS:	PTFE
O-RINGS:	FLUOROCARBON
HANDLE:	STEEL

STYLE	TYPE	MATERIAL	SIZE	OPTIONS
V	600	P	-8	-00
STYLE	V-VALVE			
TYPE	600 - THREE POSITION 633 - TWO POSITION			
MATERIAL	P- BRASS			
SIZE	8-1/2"			

SPECIFICATIONS	
PRESSURE RANGE:	<ul style="list-style-type: none"> • 150 PSI • VACUUM SERVICE TO 29 INCHES HG.
TEMPERATURE RANGES:	0° TO +250°F
OPERATING INSTRUCTIONS	POSITION HANDLE IN QUARTER-TURN INCREMENTS TO DESIRED FLOW CONFIGURATION. DETENT MECHANISM ASSISTS IN ACCURATELY POSITIONING HANDLE.



This valve can be used on applications where a fluid return or spillback is required. For use on construction equipment, chemical processing, diesel engines, filter banks, pumps and specialized industrial machinery.

Series 600 Handle Positions

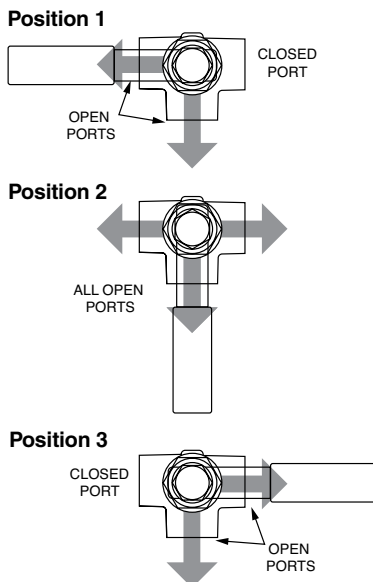

Series 633 Handle Positions

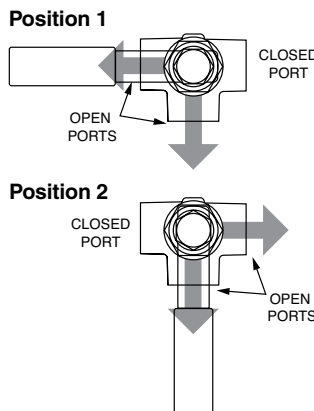

NOTE: Diversion valves do not have off positions, therefore, the center ports can not be used for shut-off purposes.



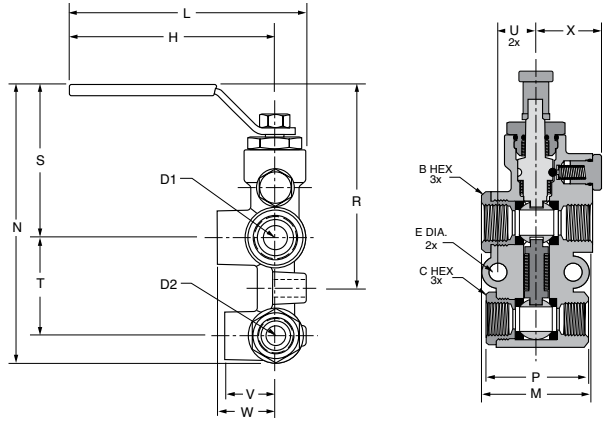

Six Port Diversion Brass Valve XV600P

PIPE THD. PART NO.	PIPE THD. TOP PORT SPL SHORT	BOTTOM PORT PTF	B HEX	C HEX	D1 FLOW	D2 FLOW	E	H	L	M	N	P	R	S	T	U	V	W	X
XV600P-8-6	1/2	3/8	1 1/16	15/16	.500	.375	.34	3.96	4.56	2.20	5.43	2.03	3.98	2.99	1.91	.73	.98	1.12	1.31

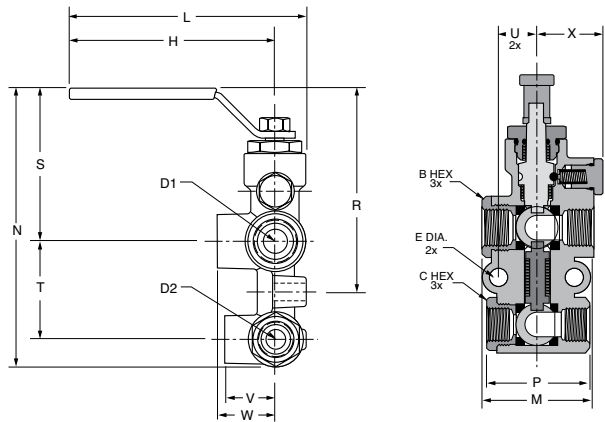

Six Port Diversion Brass Valve XV633P

PIPE THD. PART NO.	PIPE THD. TOP PORT SPL SHORT	BOTTOM PORT PTF	B HEX	C HEX	D1 FLOW	D2 FLOW	E	H	L	M	N	P	R	S	T	U	V	W	X
XV633P-8-6	1/2	3/8	1 1/16	15/16	.500	.375	.34	3.96	4.56	2.20	5.43	2.03	3.98	2.99	1.91	.73	.98	1.12	1.31



*PTF Special Short. **PTF Special Extra Short





Carbon Steel Ball Valves Series 500CS/502CS

MATERIALS OF CONSTRUCTION	
VALVE BODY:	CARBON STEEL PHOSPHATE COATED
BALL:	STEEL
SEATS / SEALS:	PTFE
HANDLE:	STEEL

STYLE	TYPE	MATERIAL	SIZE	OPTIONS
V	500	CS	-4	-00
STYLE	<ul style="list-style-type: none"> V-VALVE VP-VALVE, PADLOCKING HANDLE 			
TYPE	500 FEMALE/FEMALE PTF PORTS			
MATERIAL	CS-CRARBON STEEL			
SIZE	4-1/4", 6-3/8", 8-1/2", 12-3/4", 16-1", 20-1 1/4", 24-1 1/2", 32-2"			
OPTIONS	<ul style="list-style-type: none"> 04-TEE HANDLE 21-OVAL HANDLE 			

SPECIFICATIONS	
PRESSURE RANGE:	<ul style="list-style-type: none"> 2,000 PSI SIZES: 1/4" – 1" 1,500 PSI SOZES: 1 1/4" – 2" SATURATED STEAM UP TO 150 PSI
TEMPERATURE RANGES:	-20°F TO 425°F
OPERATING INSTRUCTIONS	QUARTER TURN IS "ON" OR "OFF". (PROVIDES POSITIVE STOP ACTION FOR FULL SHUTOFF.)
NOTE:	PERIODICALLY CHECK THE ADJUSTABLE PACKING NUT AND TIGHTEN AS REQUIRED.

FLOW DATA	
VALVE SIZE	CV
1/4	6.0
3/8	12.8
1/2	15.0
3/4	23.0
1	36.0
1-1/4	44.0
1-1/2	64.0
2	114.0



Parker's industrial ball valve product line is intended for general purpose use. Please be aware that ball valves are intended for use in the fully open or closed positions. Depending on application conditions, throttling of the valve may result in premature seal failure and/or inability to turn the valve handle.

For use as fuel line shutoffs for gasoline and diesel powered over the highway, off highway, and construction equipment vehicles. Hydraulic and general industrial applications on capital equipment and plant design plumbing that require total shutoff capability.

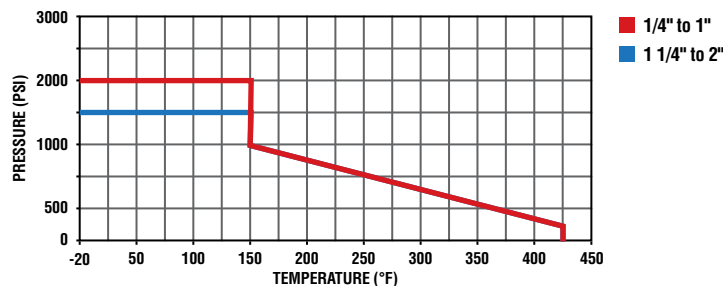

Female-Female Pipe Ends XV500CS

PART NO.	PIPE THREAD	B HEX	C HEX	H	L	M	N	D FLOW Ø
XV500CS-4	1/4	1-1/16	15/16	3.78	1.00	2.00	1.63	.400
XV500CS-6	3/8	1-1/16	15/16	3.78	1.00	2.00	1.63	.400
XV500CS-8	1/2	1-1/4	1-1/16	3.78	1.25	2.37	1.73	.540
XV500CS-12	3/4	1-5/8	1-3/8	5.10	1.50	2.90	2.08	.680
XV500CS-16	1	2	1-5/8	5.10	1.76	3.41	2.30	.880

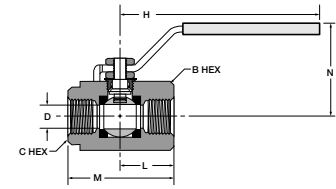

Female-Female Pipe Ends, Panel Mount XV502CS

PART NO.	PIPE THD	B HEX	C HEX	F	G	H	L	M	N	FLOW DIA. D
XV502CS-20	1-1/4	2	2-1/4	.94	1.50	6.10	1.87	3.80	2.76	1.000
XV502CS-24	1-1/2	2-5/16	2-1/2	.94	1.50	6.10	2.27	4.55	2.98	1.250
XV502CS-32	2	2-3/4	3	1.03	2.00	8.60	2.42	4.83	3.54	1.500

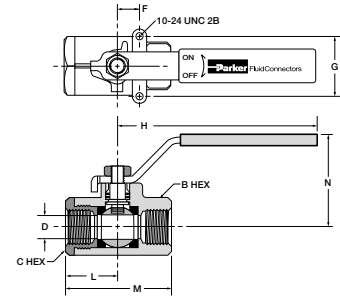

Locking Handle, Female Pipe Ends XVP500CS

PART NO.	PIPE THD	B HEX	C HEX	H	L	M	N	D FLOW Ø
XVP500CS-4	1/4	1-1/16	15/16	4.13	1.00	2.00	2.23	.400
XVP500CS-6	3/8	1-1/16	15/16	4.13	1.00	2.00	2.23	.400
XVP500CS-8	1/2	1-1/4	1-1/16	4.13	1.25	2.37	2.33	.540
XVP500CS-12	3/4	1-5/8	1-3/8	5.00	1.50	2.90	2.80	.680
XVP500CS-16	1	2	1-5/8	5.00	1.76	3.41	2.97	.880

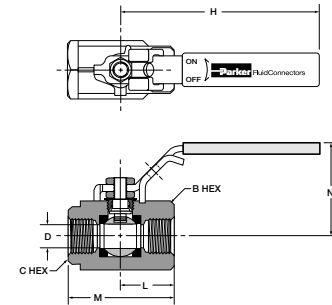

Locking Handle, Female Pipe Ends, Panel Mount XVP502CS

PART NO.	PIPE THD	B HEX	C HEX	F	G	H	L	M	N	FLOW DIA. D
XVP502CS-20	1-1/4	2	2-1/4	.94	1.50	7.50	1.87	3.80	3.15	1.000
XVP502CS-24	1-1/2	2-5/16	2-1/2	.94	1.50	7.50	2.27	4.55	3.37	1.250
XVP502CS-32	2	2-3/4	3	1.03	2.00	8.75	2.42	4.83	3.46	1.500

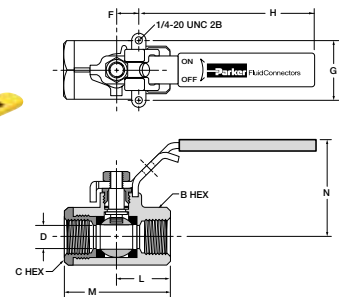

Tee Handle, Female Pipe Ends XV500CS-X-04

PART NO.	PIPE THD	B HEX	C HEX	H	L	M	N	D FLOW Ø
XV500CS-4-04	1/4	1-1/16	15/16	2.16	1.08	2.00	1.41	.400
XV500CS-6-04	3/8	1-1/16	15/16	2.16	1.08	2.00	1.41	.400
XV500CS-8-04	1/2	1-1/4	1-1/16	2.90	1.45	2.37	1.66	.540
XV500CS-12-04	3/4	1-5/8	1-3/8	3.63	1.81	2.90	2.06	.680
XV500CS-16-04	1	2	1-5/8	3.63	1.81	3.41	2.23	.880

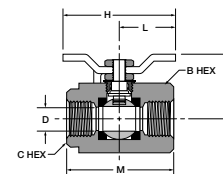

Oval Handle, Female Pipe Ends XV500CS-X-21

PART NO.	PIPE THD	B HEX	C HEX	H	L	M	N	D FLOW Ø
XV500CS-4-21	1/4	1-1/16	15/16	3.50	1.00	2.00	1.66	.400
XV500CS-6-21	3/8	1-1/16	15/16	3.50	1.00	2.00	1.66	.400
XV500CS-8-21	1/2	1-1/4	1-1/16	3.50	1.13	2.37	1.76	.540
XV500CS-12-21	3/4	1-5/8	1-3/8	5.00	1.46	2.90	2.13	.680
XV500CS-16-21	1	2	1-5/8	5.00	1.58	3.41	2.29	.880

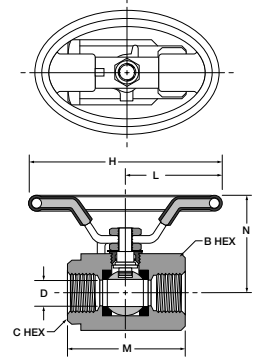

Oval Handle, Female Pipe Ends, Panel Mount XV502CS-X-21

PART NO.	PIPE THD	B HEX	C HEX	F	G	H	L	M	N	FLOW DIA. D
XV502CS-20-21	1-1/4	2	2-1/4	.94	1.50	5.07	2.53	3.80	3.04	1.000
XV502CS-24-21	1-1/2	2-5/16	2-1/2	.94	1.50	5.07	2.53	4.55	3.26	1.250
XV502CS-32-21	2	2-3/4	3	1.03	2.00	6.50	3.25	4.83	3.57	1.500

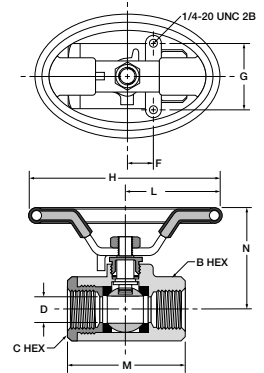



Carbon Steel Ball Valves Series 506CS

MATERIALS OF CONSTRUCTION	
VALVE BODY:	CARBON STEEL PHOSPHATE COATED
BALL:	STEEL
SEATS / SEALS:	PTFE
HANDLE:	STEEL

STYLE	TYPE	MATERIAL	SIZE	OPTIONS
V	506	CS	-4	-00
STYLE	<ul style="list-style-type: none"> V-VALVE VP-VALVE, PADLOCKING HANDLE 			
TYPE	506-FEMALE/FEMALE SAE STRAIGHT THREAD PORTS			
MATERIAL	CS-CARBON STEEL			
SIZE	4-1/4", 6-3/8", 8-1/2", 12-3/4", 16-1"			

SPECIFICATIONS	
PRESSURE RANGE:	<ul style="list-style-type: none"> 3,000 PSI SATURATED STEAM UP TO 150 PSI
TEMPERATURE RANGES:	-20°F TO 425°F
OPERATING INSTRUCTIONS	QUARTER TURN IS "ON" OR "OFF". (PROVIDES POSITIVE STOP ACTION FOR FULL SHUTOFF.)



FLOW DATA	
VALVE SIZE	CV
1/4	6.0
3/8	12.0
1/2	15.0
3/4	34.0
1	54.0

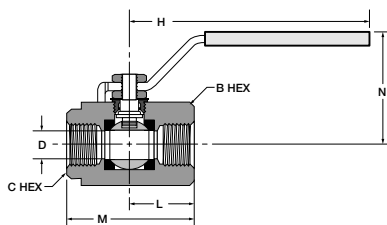

Parker's industrial ball valve product line is intended for general purpose use. Please be aware that ball valves are intended for use in the fully open or closed positions. Depending on application conditions, throttling of the valve may result in premature seal failure and/or inability to turn the valve handle.

For use as fuel line shutoffs for gasoline and diesel powered over the highway, off highway, and construction equipment vehicles. Hydraulic and general industrial applications on capital equipment and plant design plumbing that require total shutoff capability.

Female-Female SAE Straight Thread Ports XV506CS

PART NO.	STRAIGHT THREAD	B HEX	C HEX	H	L	M	N	D FLOW Ø
XV506CS-4	7/16-20	1-1/16	15/16	3.78	1.00	2.00	1.63	.400
XV506CS-6	9/16-18	1-1/16	15/16	3.78	1.00	2.00	1.63	.400
XV506CS-8	3/4-16	1-5/8	1-1/4	4.78	1.32	2.84	2.16	.500
XV506CS-12	1-1/16-12	1-7/8	1-5/8	4.78	1.66	3.71	2.35	.750
XV506CS-16	1-5/16-12	2-1/2	2-1/8	6.10	1.88	4.15	2.85	1.000

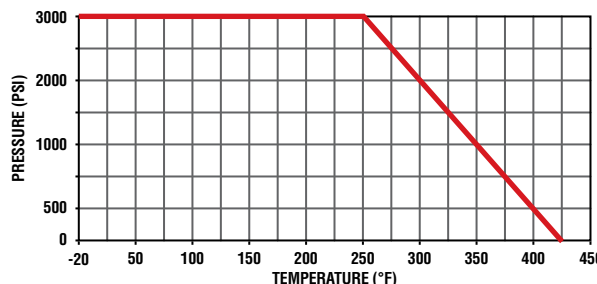



High Pressure Carbon Steel Ball Valves Series 500HP, 506HP, 507HP

MATERIALS OF CONSTRUCTION	
VALVE BODY:	CARBON STEEL
BALL:	STEEL
SEATS:	DELTRIN WITH MOLYBDENUM DISULPHIDE
STEM SEALS:	NITRILE O-RINGS
HANDLE:	STEEL

SPECIFICATIONS	
PRESSURE RANGE:	6,000 PSI
TEMPERATURE RANGES:	-10° TO +210°F
OPERATING INSTRUCTIONS	QUARTER TURN IS "ON" OR "OFF" (PROVIDES POSITIVE STOP ACTION FOR FULL SHUTOFF.)

STYLE	TYPE	MATERIAL	SIZE
V	590	HP	-4
STYLE	V-VALVE VP-VALVE, PADLOCKING HANDLE		
TYPE	500-FEMALE/FEMALE NPT PORTS		
MATERIAL	HP-HIGH PRESSURE CARBON STEEL		
SIZE	4-1/4", 6-3/8", 8-1/2", 12-3/4", 16-1", 20-1/4", 24-1 1/2", 32-2"		

STYLE	TYPE	MATERIAL	SIZE
V	506	HP	-4
STYLE	V-VALVE VP-VALVE, PADLOCKING HANDLE		
TYPE	506-FEMALE/FEMALE SAE STRAIGHT THREAD PORTS		
MATERIAL	HP-HIGH PRESSURE CARBON STEEL		
SIZE	4-1/4", 6-3/8", 8-1/2", 12-3/4", 16-1", 20-1/4", 24-1 1/2", 32-2"		

STYLE	TYPE	MATERIAL	SIZE
V	507	HP	-M18
STYLE	V-VALVE		
TYPE	507-FEMALE / FEMALE ISO 6149 PORTS		
MATERIAL	HP-HIGH PRESSURE CARBON STEEL		
SIZE	M18X1.5, M27X2		



Parker's industrial ball valve product line is intended for general purpose use. Please be aware that ball valves are intended for use in the fully open or closed positions. Depending on application conditions, throttling of the valve may result in premature seal failure and/or inability to turn the valve handle.

Pressure Drop (PSI)

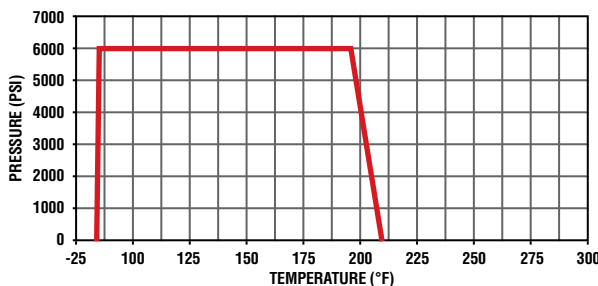
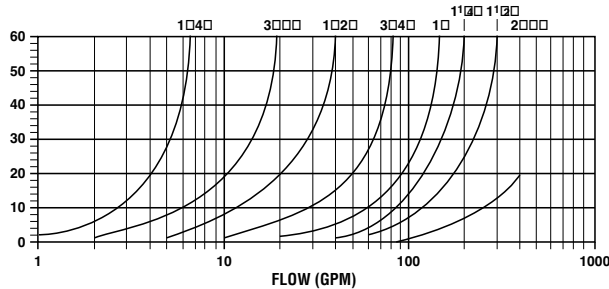

6000 PSI Female-Female Pipe Ends XV500HP-X

PART NO.	PIPE THREAD (NPT)	B	C	H	L	M	N	FLOW DIA. D
XV500HP-4	1/4-18	.69	1.38	4.50	1.44	2.75	2.94	.240
XV500HP-6	3/8-18	.56	1.50	4.50	1.69	2.88	3.06	.390
XV500HP-8	1/2-14	.75	1.63	4.50	1.88	3.38	3.19	.510
XV500HP-12	3/4-14	.69	2.25	7.00	2.41	3.81	4.69	.790
XV500HP-16	1-11.5	.94	2.50	7.00	2.56	4.50	4.94	.950

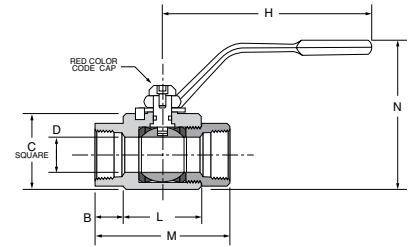

6000 PSI Female-Female Pipe Ends XV500HP-X (LARGE)

PART NO.	PIPE THREAD (NPT)	B	C	H	L	M	N	FLOW DIA. D
XV500HP-20	1 1/4-11.5	.85	3.25	10.00	3.15	4.84	6.31	1.26
XV500HP-24	1 1/2-11.5	.99	3.75	10.00	3.35	5.33	6.76	1.50
XV500HP-32	2-11.5	1.30	4.50	10.00	3.94	6.54	7.42	1.89

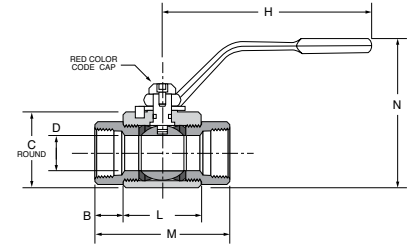

6000 PSI Locking-Female-Female Pipe Ends XVP500HP-X

PART NO.	PIPE THREAD (NPT)	B	C	H	L	M	N	FLOW DIA. D
XVP500HP-4	1/4-18	.69	1.38	4.50	1.44	2.75	2.94	.240
XVP500HP-6	3/8-18	.56	1.50	4.50	1.69	2.88	3.06	.390
XVP500HP-8	1/2-14	.75	1.63	4.50	1.88	3.38	3.19	.510
XVP500HP-12	3/4-14	.69	2.25	7.00	2.41	3.81	4.69	.790
XVP500HP-16	1-11.5	.94	2.50	7.00	2.56	4.50	4.94	.950

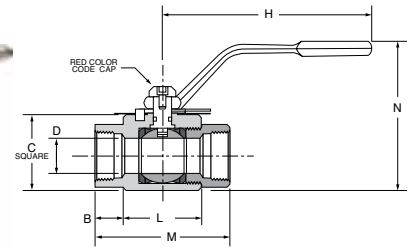

K

6000 PSI Locking-Female-Female Pipe Ends XVP500HP-X (LARGE)

PART NO.	PIPE THREAD (NPT)	B	C	H	L	M	N	FLOW DIA. D
XVP500HP-20	1 1/4-11.5	.85	3.25	10.00	3.15	4.84	6.31	1.26
XVP500HP-24	1 1/2-11.5	.99	3.75	10.00	3.35	5.33	6.76	1.50
XVP500HP-32	2-11.5	1.30	4.50	10.00	3.94	6.54	7.42	1.89

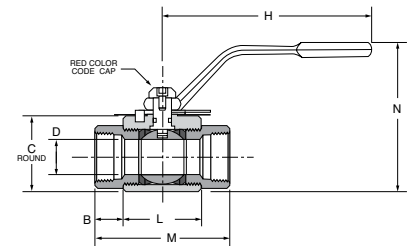

**6000 PSI Female-Female Straight Thread Ends
XV506HP-X**

PART NO.	SAE J1926-1 THREAD	B	C	H	L	M	N	FLOW DIA. D
XV506HP-4	7/16-20 UNF	.69	1.38	4.50	1.44	2.75	2.94	.240
XV506HP-6	9/16-18 UNF	.56	1.50	4.50	1.69	2.88	3.06	.390
XV506HP-8	3/4-16 UNF	.75	1.63	4.50	1.88	3.38	3.19	.510
XV506HP-12	1 1/16-12 UNF	.69	2.25	7.00	2.41	3.81	4.69	.790
XV506HP-16	1 5/16-12 UNF	.94	2.50	7.00	2.56	4.50	4.94	.950

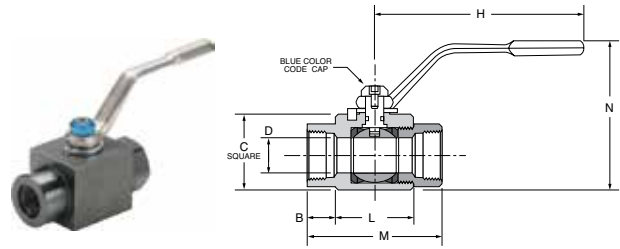

**6000 PSI Female-Female Straight Thread Ends
XV506HP-X (LARGE)**

PART NO.	SAE J1926-1 THREAD	B	C	H	L	M	N	FLOW DIA. D
XV506HP-20	1 5/8-12 UNF	.85	3.25	10.00	3.15	4.84	6.31	1.26
XV506HP-24	1 7/8-12 UNF	.99	3.75	10.00	3.35	5.33	6.76	1.50
XV506HP-32	2 1/2-12 UNF	1.30	4.50	10.00	3.94	6.54	7.42	1.89

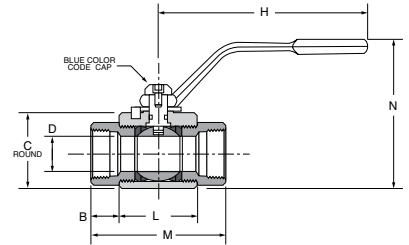

**6000 PSI Locking-Female-Female Straight
Thread Ends XVP506HP-X**

PART NO.	SAE J1926-1 THREAD	B	C	H	L	M	N	FLOW DIA. D
XVP506HP-4	7/16-20 UNF	.69	1.38	4.50	1.44	2.75	2.94	.240
XVP506HP-6	9/16-18 UNF	.56	1.50	4.50	1.69	2.88	3.06	.390
XVP506HP-8	3/4-16 UNF	.75	1.63	4.50	1.88	3.38	3.19	.510
XVP506HP-12	1 1/16-12 UNF	.69	2.25	7.00	2.41	3.81	4.69	.790
XVP506HP-16	1 5/16-12 UNF	.94	2.50	7.00	2.56	4.50	4.94	.950

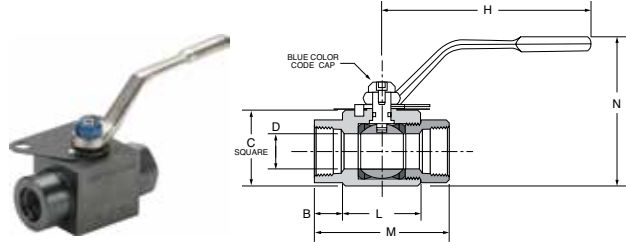

**6000 PSI Locking-Female-Female Straight
Thread Ends XVP506HP-X (LARGE)**

PART NO.	SAE J1926-1 THREAD	B	C	H	L	M	N	FLOW DIA. D
XVP506HP-20	1 5/8-12 UNF	.85	3.25	10.00	3.15	4.84	6.31	1.26
XVP506HP-24	1 7/8-12 UNF	.99	3.75	10.00	3.35	5.33	6.76	1.50
XVP506HP-32	2 1/2-12 UNF	1.30	4.50	10.00	3.94	6.54	7.42	1.89

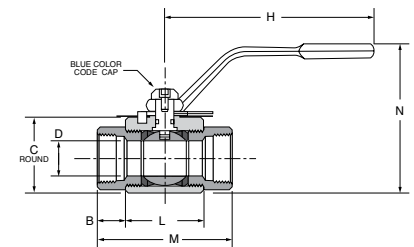



Stainless Steel Ball Valves Series 501SS

MATERIALS OF CONSTRUCTION	
VALVE BODY:	CF-8M STAINLESS STEEL
BALL:	STAINLESS STEEL
SEATS / SEALS:	PTFE
HANDLE:	STAINLESS STEEL

PRESSURE AND TEMPERATURE RANGE	
PRESSURE RANGE	2,000 PSI
VACUUM SERVICE	28 INCHES HG
TEMPERATURE RANGE	0° TO +400°F

STYLE	TYPE	MATERIAL	SIZE	OPTIONS
V	501	SS	-4	-00
STYLE	V-VALVE			
TYPE	501-MALE/FEMALE NPT PORTS			
MATERIAL	SS-STAINLESS STEEL			
SIZE	4-1/4", 6-3/8", 8-1/2", 12-3/4", 16-1"			

APPROVALS
MEETS MATERIAL REQUIREMENTS OF NACE MR-01-75

Note: Periodically check the adjustable packing nut and tighten as required.



Parker's industrial ball valve product line is intended for general purpose use. Please be aware that ball valves are intended for use in the fully open or closed positions. Depending on application conditions, throttling of the valve may result in premature seal failure and/or inability to turn the valve handle.

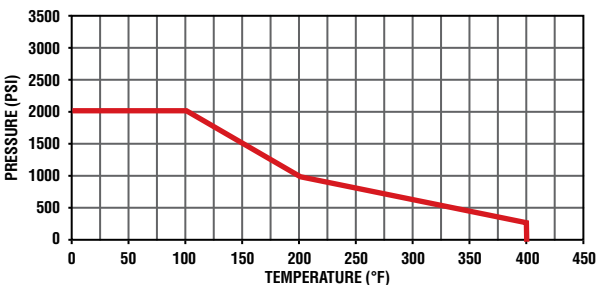

Applications include chemical plants, refineries, steel mills, industrial fuel lines and agricultural equipment. Meets material requirements of NACE MR-01-75.

Mounting Detail

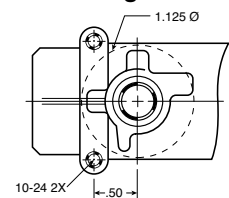

Male-Female Pipe Ends XV501SS

PART NO.	PIPE THREAD (NPT)	HEX	F	G	L	M	N	D FLOW Ø
XV501SS-4	1/4	15/16	.50	1.12	5.60	2.65	1.97	.280
XV501SS-6	3/8	15/16	.50	1.12	5.60	2.65	1.97	.375
XV501SS-8	1/2	1-1/16	.50	1.12	5.85	3.05	2.00	.500
XV501SS-12	3/4	1-3/8	.88	1.37	7.27	3.85	2.55	.720
XV501SS-16	1	1-5/8	.88	1.37	7.48	4.25	2.68	.940

FLOW DATA	
VALVE SIZE	CV
1/4	4.0
3/8	6.0
1/2	14.0
3/4	35.0
1	54.0

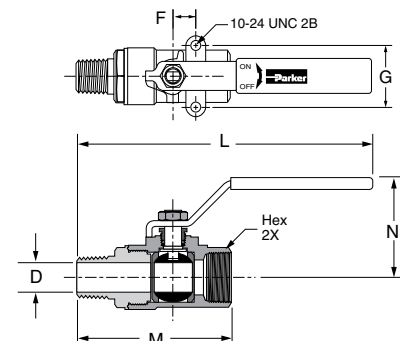



Stainless Steel Ball Valves Series 502SS

MATERIALS OF CONSTRUCTION	
VALVE BODY:	CF-8M STAINLESS STEEL
BALL:	STAINLESS STEEL
SEATS / SEALS:	PTFE
HANDLE:	STAINLESS STEEL

PRESSURE AND TEMPERATURE RANGE	
PRESSURE RANGE	2,000 PSI SIZES: 1/4" – 1" 1,500 PSI SIZES: 1-1/4" – 2"
VACUUM SERVICE	28 INCHES HG
TEMPERATURE RANGE	0° TO +400°F

STYLE	TYPE	MATERIAL	SIZE	OPTIONS
V	502	SS	-4	-00
STYLE	V-VALVE VP-VALVE, PADLOCKING HANDLE			
TYPE	502-PANEL MOUNT FEMALE/FEMALE NPT PORTS			
MATERIAL	SS-STAINLESS STEEL			
SIZE	4-1/4", 6-3/8", 8-1/2", 12-3/4", 16-1", 20-1-1/4", 24-1-1/2", 32-2"			
OPTIONS	20-SHORT HANDLE 21-OVAL HANDLE 35-WELDED RETAINER NUT			

APPROVALS
MEETS MATERIAL REQUIREMENTS OF NACE MR-01-75

FLOW DATA		MOUNTING HOLE DIAMETER	
VALVE SIZE	CV	VALVE SIZE	DIA. IN.
1/4	4.0	1/4	1.125
3/8	6.0	3/8	1.125
1/2	14.0	1/2	1.125
3/4	35.0	3/4	1.500
1	54.0	1	1.500
1 1/4	74.0	1 1/4	1.875
1 1/2	120.0	1 1/2	1.875
2	226.0	2	1.875



Parker's industrial ball valve product line is intended for general purpose use. Please be aware that ball valves are intended for use in the fully open or closed positions. Depending on application conditions, throttling of the valve may result in premature seal failure and/or inability to turn the valve handle.

Applications include chemical plants, refineries, steel mills, industrial fuel lines and agricultural equipment. Meets material requirements of NACE MR-01-75.

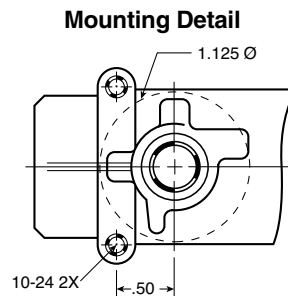
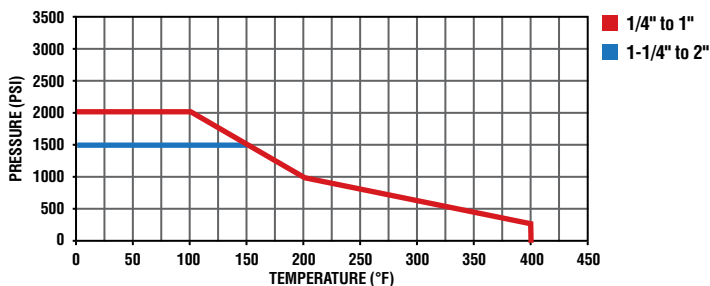

Note: Periodically check the adjustable packing nut and tighten as required.



Female Pipe Ends, Panel Mount XV502SS

PART NO.	PIPE THD (NPT)	B/C HEX	F	G	H	I THREAD	L	M	N	PANEL FLOW DIA. D	HOLE DIA.
XV502SS-4	1/4	15/16	.500	1.125	4.00	10-24 UNC	5.03	2.07	2.52	.380	1.125
XV502SS-6	3/8	15/16	.500	1.125	4.00	10-24 UNC	5.03	2.07	2.52	.380	1.125
XV502SS-8	1/2	1-1/16	.500	1.125	4.00	10-24 UNC	5.13	2.27	2.65	.500	1.125
XV502SS-12	3/4	1-3/8	.875	1.375	5.00	10-24 UNC	6.67	3.35	3.46	.790	1.500
XV502SS-16	1	1-5/8	.875	1.375	5.00	10-24 UNC	6.77	3.54	3.74	1.000	1.500
XV502SS-20	1-1/4	2	1.000	1.500	7.00	1/4-20 UNC	9.00	4.00	4.55	1.250	2.000
XV502SS-24	1-1/2	2-3/8	1.000	1.500	7.00	1/4-20 UNC	7.19	4.38	5.42	1.500	2.000
XV502SS-32	2	3	1.000	1.500	7.00	1/4-20 UNC	9.75	5.50	5.68	2.000	2.000

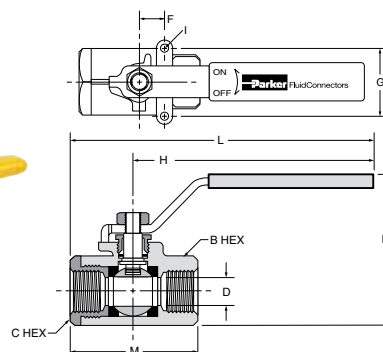

Short Handle, Female Pipe Ends, Panel Mount XV502SS-X-20

PART NO.	PIPE THREAD (NPT)	B/C HEX	G	H	L	M	N	FLOW DIA. D
XV502SS-4-20	1/4	15/16	1.12	2.28	3.32	2.07	2.53	.375
XV502SS-6-20	3/8	15/16	1.12	2.28	3.32	2.07	2.53	.375
XV502SS-8-20	1/2	1-1/16	1.12	2.22	3.37	2.25	2.63	.500

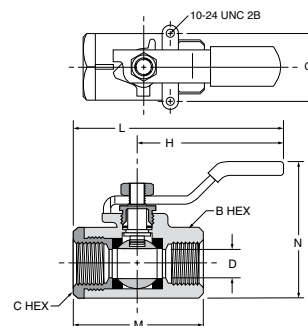

Locking Handle, Female Pipe Ends, Panel Mount XVP502SS

PART NO.	PIPE THD (NPT)	B/C HEX	F	G	H	I THREAD	L	M	N	PANEL FLOW DIA. D	HOLE DIA.
XVP502SS-4	1/4	15/16	.500	1.125	4.00	10-24 UNC	5.03	2.07	2.52	.380	1.125
XVP502SS-6	3/8	15/16	.500	1.125	4.00	10-24 UNC	5.03	2.07	2.52	.380	1.125
XVP502SS-8	1/2	1-1/16	.500	1.125	4.00	10-24 UNC	5.13	2.27	2.65	.500	1.125
XVP502SS-12	3/4	1-3/8	.875	1.375	5.00	10-24 UNC	6.67	3.35	3.46	.790	1.500
XVP502SS-16	1	1-5/8	.875	1.375	5.00	10-24 UNC	6.77	3.54	3.74	1.000	1.500
XVP502SS-20	1-1/4	2	1.000	1.500	7.00	1/4-20 UNC	9.00	4.00	4.55	1.250	2.000
XVP502SS-24	1-1/2	2-3/8	1.000	1.500	7.00	1/4-20 UNC	7.19	4.38	5.42	1.500	2.000
XVP502SS-32	2	3	1.000	1.500	7.00	1/4-20 UNC	9.75	5.50	5.68	2.000	2.000

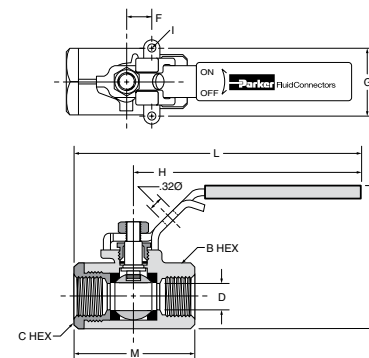

Oval Handle, Female Pipe Ends, Panel Mount XV502SS-X-21

PART NO.	PIPE THD (NPT)	B/C HEX	G	H	L	I THREAD	M	N	PANEL FLOW DIA. D	HOLE DIA.
XV502SS-4-21	1/4	15/16	1.125	1.74	3.48	10-24 UNC	2.07	2.43	.380	1.125
XV502SS-6-21	3/8	15/16	1.125	1.74	3.48	10-24 UNC	2.07	2.43	.380	1.125
XV502SS-8-21	1/2	1-1/16	1.125	1.74	3.48	10-24 UNC	2.27	2.54	.500	1.125
XV502SS-12-21	3/4	1-3/8	1.375	2.68	5.36	10-24 UNC	3.35	3.45	.790	1.500
XV502SS-16-21	1	1-5/8	1.375	2.68	5.36	10-24 UNC	3.54	3.74	1.000	1.500
XV502SS-20-21	1-1/4	2	1.500	3.27	6.53	1/4-20 UNC	4.00	4.54	1.250	2.000
XV502SS-24-21	1-1/2	2-3/8	1.500	3.27	6.53	1/4-20 UNC	4.38	4.93	1.500	2.000
XV502SS-32-21	2	3	1.500	3.27	6.53	1/4-20 UNC	5.50	5.67	2.000	2.000

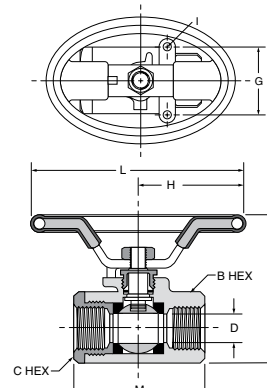



Rotary Actuator Ball Valves Series ACT

PRESSURE AND TEMPERATURE RANGE	
PRESSURE RANGE	150 PSI maximum air pressure to actuator
TEMPERATURE RANGE	Ambient temperature -40° to +180°F



How Do Vane Actuators Work?

Parker vane actuators provide the maximum amount of output torque from the smallest possible envelope size. They convert fluid power pressure into rotary motion for a wide variety of industrial applications. Double vane units produce twice the torque output of single vane actuators from identical envelope dimensions and have a maximum rotation of 95°.

A short cylindrical chamber encloses a vane attached to a central shaft. Fluid pressure differential is applied through a stationary barrier (stator) within the cylinder to one side of the vane. The opposite side of the vane is connected to exhaust through the stator. This pressure differential produces rotation of the vane and central shaft. Due to vane actuator design there will always be some internal bypass in these units.

Rotary Actuator Series ACT Features

- 1. Heads**-are precision machined from aluminum, then hard-coat anodized and PTFE impregnated to ensure long seal life and low breakaway pressure.
- 2. Body** - is machined from a one-piece aluminum extrusion that incorporates the stator for superior rigidity. The extrusion is hard-coat anodized and PTFE impregnated, resulting in a smooth, slick seal surface which guarantees long seal life and low breakaway pressure.

- 3. Shoulder Seal** - a nitrile-energized, PTFE seal is used to reduce bypass flow and friction, providing superior performance and long life.

- 4. Shaft Seal** - the high-quality, self-lubricated, abrasion-resistant nitrile seal is a multiple lobe construction for leakfree operation and greater reliability.

- 5. Shaft** - stainless steel provides high strength and corrosion resistance for the most demanding applications.

- 6. Bearings** - hard-coat anodized aluminum-bearing surface with permanent solid film lubricant provides substantial shaft support and wear resistance, ensuring continuous lubrication, high performance, and long life.

- 7. Mounting** - combination face and base mounting offer flexibility in application and design.

- 8. Vane Seal** - a special self-lubricated, abrasion-resistant nitrile compound is molded into a one-piece vane seal, providing low breakaway pressure and long life, even with no lubrication. The vane seal is also removable so that field repairs can be made, if necessary.

- 9. Vane** - a hard-coat anodized aluminum extrusion permanently affixed to shaft, forming a structurally sound assembly. The light weight also reduces inertia allowing faster operating speeds.

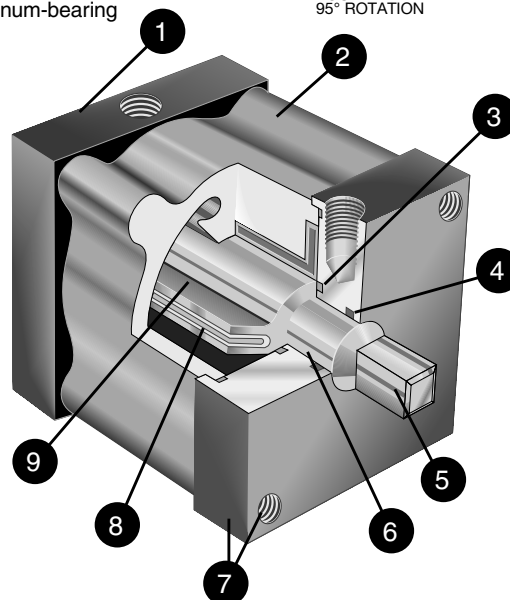
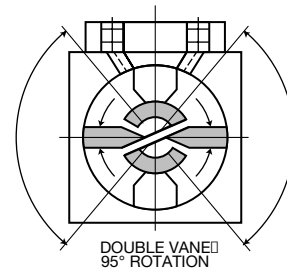

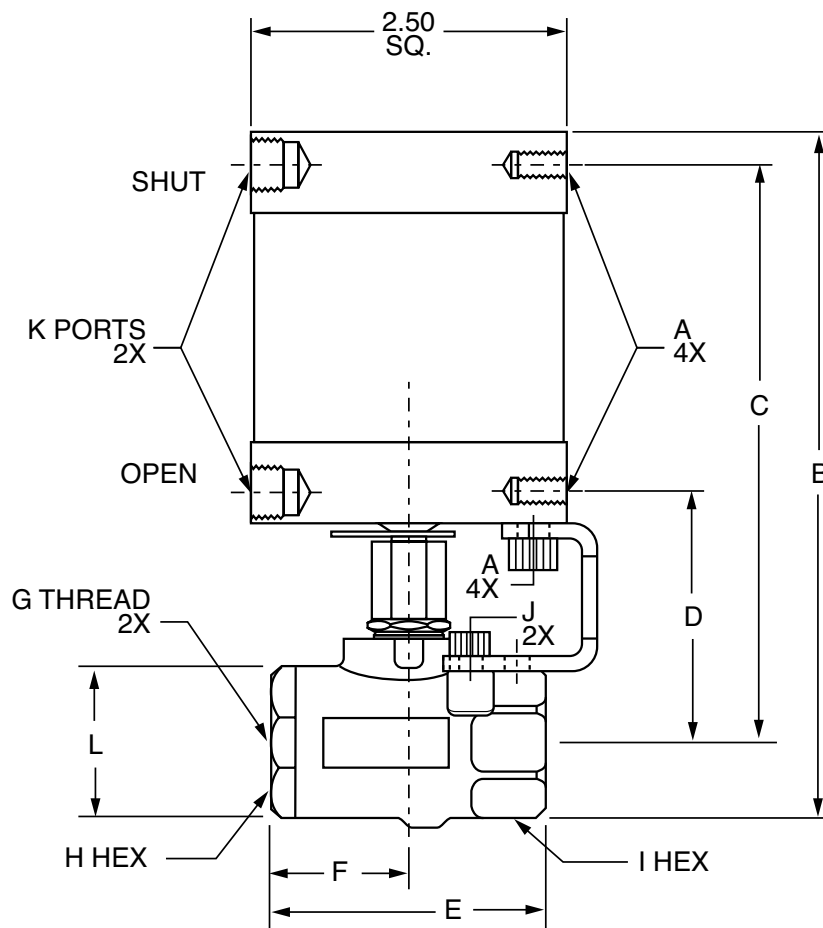

Rotary Actuator, Female Pipe Ends XV502P-X-ACT

PART NO.	SIZE	A MTG. HOLES	B	C	D	E	F	G	H HEX	I HEX	J UNC	K NPTF	L	FLOW DIA.	FLOW CV	MIN. ACT PRESSURE (PSI)
XV502P-4-ACT	1/4	1/4-20 UNC	5.25	4.47	1.91	2.03	1.00	1/4-18PTF	15/16	15/16	10-24	1/8-27	1.06	.375	4.0	50
XV502P-6-ACT	3/8	1/4-20 UNC	5.25	4.47	1.91	2.03	1.00	3/8-18PTF	15/16	15/16	10-24	1/8-27	1.06	.375	5.8	50
XV502P-8-ACT	1/2	1/4-20 UNC	5.38	4.54	1.98	2.20	1.09	1/2-14PTF*	1-1/16	1-1/16	10-24	1/8-27	1.19	.500	12.0	50
XV502P-12-ACT	3/4	1/4-20 UNC	5.57	4.63	2.07	2.42	1.29	3/4-14PTF**	1-5/16	1-1/4	10-24	1/8-27	1.38	.685	25.0	75
XV502P-16-ACT	1	1/4-20 UNC	5.85	4.76	2.20	2.75	1.38	1-11.5PTF**	1-9/16	1-1/2	10-24	1/8-27	1.67	.875	35.0	75

Stainless Steel Rotary Actuator, Female Pipe Ends XV502SS-X-ACT

PART NO.	SIZE	A MTG. HOLES	B	C	D	E	F	G	H/I HEX	J	K NPTF	L	FLOW DIA.	FLOW CV
XV502SS-4-ACT	1/4	1/4-20 UNC	5.41	4.61	2.05	2.07	1.04	1/4-18 NPT	15/16	10-24	1/8-27	1.10	.375	4.0
XV502SS-6-ACT	3/8	1/4-20 UNC	5.41	4.61	2.05	2.07	1.04	3/8-18 NPT	15/16	10-24	1/8-27	1.10	.375	6.0
XV502SS-8-ACT	1/2	1/4-20 UNC	5.53	4.64	2.08	2.27	1.17	1/2-14 NPT	1 1/16	10-24	1/8-27	1.28	.500	14.0

*Ptf Special Short. **Ptf Special Extra Short



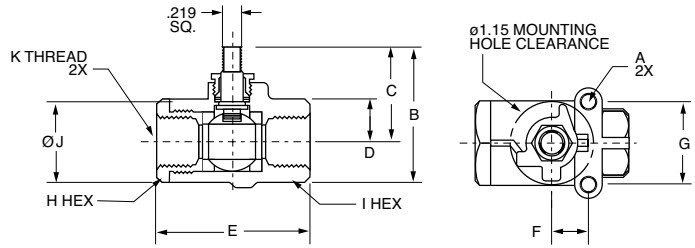

Actuator Sub-Assembly XV502P-X-SUB

PART NO	SIZE	A UNC	B	C	D	E	F	G	H HEX	I HEX	J	K
XV502P-4-SUB	1/4	10-24	1.68	1.15	.495	2.03	.50	1.12	15/16	15/16	1.06	1/4-18 PTF
XV502P-6-SUB	3/8	10-24	1.68	1.15	.495	2.03	.50	1.12	15/16	15/16	1.06	3/8-18 PTF
XV502P-8-SUB	1/2	10-24	1.78	1.19	.565	2.20	.50	1.12	1-1/16	1-1/16	1.19	1/2-14 PTF*
XV502P-12-SUB	3/4	10-24	2.09	1.40	.655	2.42	.87	1.37	1-5/16	1-1/4	1.38	3/4-14 PTF**
XV502P-16-SUB	1	10-24	2.38	1.54	.785	2.75	.87	1.37	1-9/16	1-1/2	1.67	1-11.5 PTF**

* PTF Special Short

** PTF Special Extra Short

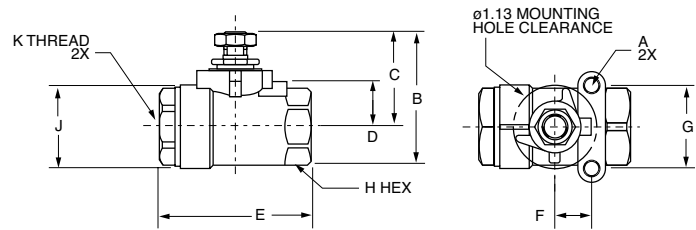

Actuator Sub-Assembly XV502SS-X-SUB

PART NO	SIZE	A UNC	B	C	D	E	F	G	H HEX	J	K
XV502SS-4-SUB	1/4	10-24	1.88	1.32	.63	2.07	.50	1.12	15/16	1.10	1/4-18 NPT
XV502SS-6-SUB	3/8	10-24	1.88	1.32	.63	2.07	.50	1.12	15/16	1.10	3/8-18 NPT
XV502SS-8-SUB	1/2	10-24	2.00	1.35	.66	2.27	.50	1.12	1-1/16	1.28	1/2-14 NPT

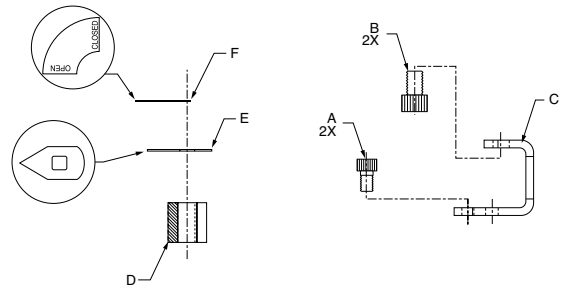

ACT-P-X-KIT

PART NO.	FOR USE WITH	A	B	C	D	E	F
ACT-P-1-KIT	XV502P-4, 6, 8-ACT	10-24 UNC	1/4-20 UNC	BRACKET	.60 LONG COUPLING	POSITION INDICATOR	POSITION LABEL
ACT-P-2-KIT	XV502P-12, 16-ACT	10-24 UNC	1/4-20 UNC	BRACKET	.55 LONG COUPLING	POSITION INDICATOR	POSITION LABEL

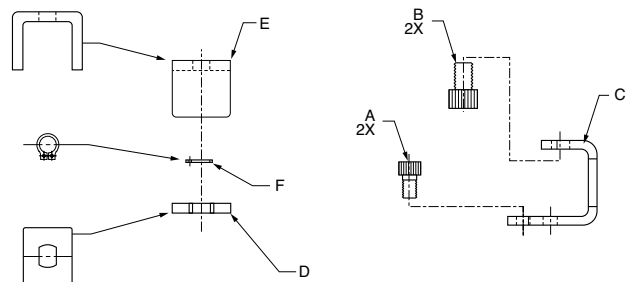

ACT-SS-X-KIT

PART NO.	FOR USE WITH	A	B	C	D	E	F
ACT-SS-1-KIT	XV502SS-4, 6, 8-ACT	10-24 UNC	1/4-20 UNC	BRACKET	CLIP	HANDLE YOKE	SNAP RING





Parker Metric Ball Valve Series BVGC

MATERIALS OF CONSTRUCTION	
VALVE BODY:	BRASS NICKEL PLATED TO DIN 17660 AND UNI 5705
BALL:	BRASS CHROME PLATED
SEATS / SEALS:	PTFE WITH SILICONE FREE LUBRICANT
PACKING GLAND:	PTFE
HANDLE:	LEVER - CARBON STEEL COMPACT - ALUMINUM

SPECIFICATIONS	
FEMALE BSPP SHORT THREADS MANUFACTURED IN ACCORDANCE TO ISO 228 / DIN 259	



Operating pressures and temperatures

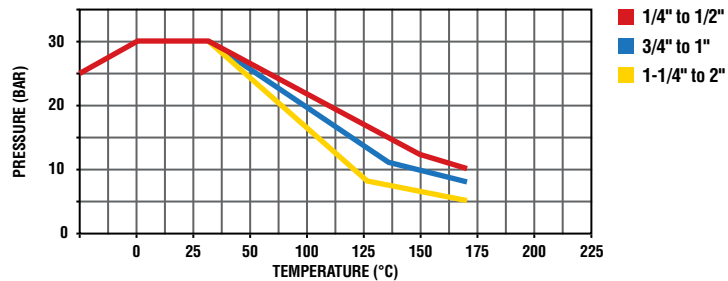

N.B. This chart gives general information. Only testing under operating conditions will finally determine which valve should be selected.

Advantages

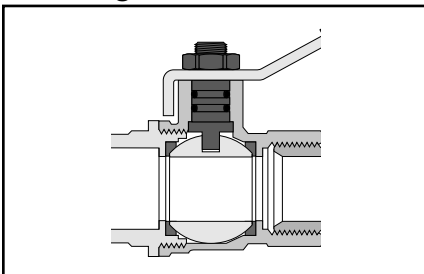

Adjustable packing

The PTFE packing gland and adjustable washer are designed to give longer service life and lower operating torques.

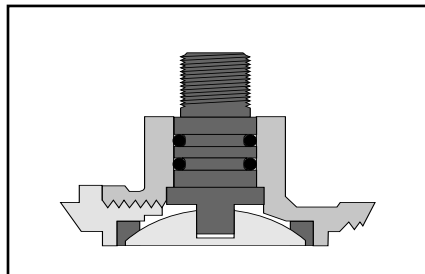

Anti extrusion stem

The BVGC series ball valves are fitted with an anti-extrusion stem to prevent blow out in the case of pressure peaks.

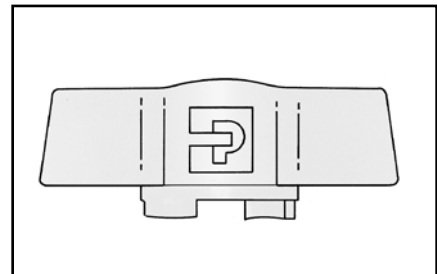

Compact handle

For applications where space is at a premium, the BVGC series valve is available with a compact handle in sizes up to 1".

BVGC BSPP Female/Female Valve With Lever Handle

PART NO.	DN MM	THREAD BSPP	C	H	L	L1	O
BVG4-1/4C	8	1/4	20	39.5	39	82	25.0
BVG4-3/8C	10	3/8	20	39.5	39	82	25.0
BVG4-1/2C	15	1/2	25	44.0	50	100	32.5
BVG4-3/4C	20	3/4	31	50.0	54	120	39.0
BVG4-1C	25	1	38	54.0	67	120	47.5
BVG4-1.1/4C	32	1.1/4	48	76.5	77	158	59.0
BVG4-1.1/2C	40	1.1/2	54	82.5	90	158	71.5
BVG4-2C	50	2	66	89.5	106	158	86.0

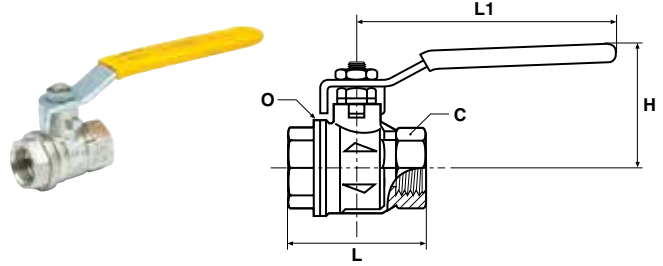

BVGT4 BSPP Female/Female Valve with Compact Handle

PART NO.	DN MM	THREAD BSPP	C	H	L	L1	O
BVGT4-1/4C	8	1/4	20	40	39	50	25.0
BVGT4-3/8C	10	3/8	20	40	39	50	25.0
BVGT4-1/2C	15	1/2	25	44	50	50	32.5
BVGT4-3/4C	20	3/4	31	49	54	60	39.0
BVGT4-1C	25	1	38	53	67	60	47.5

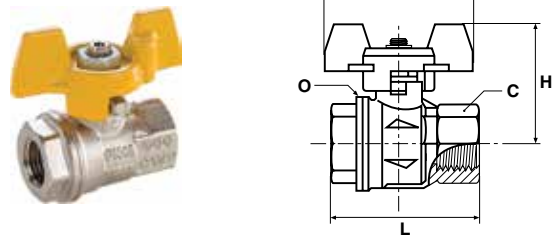



Parker Metric Ball Valve Series BVGL

MATERIALS OF CONSTRUCTION	
VALVE BODY:	BRASS NICKEL PLATED TO DIN 17660 AND UNI 5705
BALL:	BRASS CHROME PLATED
SEATS / SEALS:	PTFE WITH SILICONE FREE LUBRICANT
STEM SEAL:	FLUOROCARBON O-RINGS
HANDLE:	LEVER - CARBON STEEL COMPACT - ALUMINUM

SPECIFICATIONS
FEMALE THREADS MANUFACTURED IN ACCORDANCE TO DIN 2999/ISO 228.



Operating pressures and temperatures

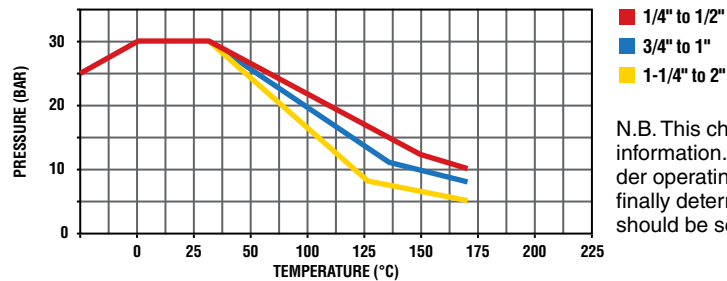

N.B. This chart gives general information. Only testing under operating conditions will finally determine which valve should be selected.



Advantages

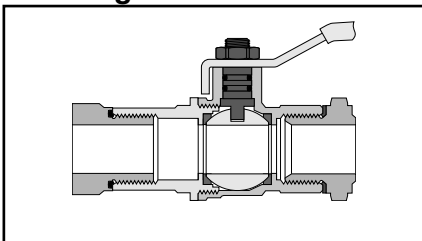

Long female threads

BVGL series valves are manufactured with long female threads in accordance to DIN 2999/ISO 228. This enables the valves to be used with Prestolok, Metru-Lok and brass adaptors but also Parker's range of steel hydraulic fittings, e.g. Triple-Lok, O-Lok, EO, and BSPP coned adaptors.

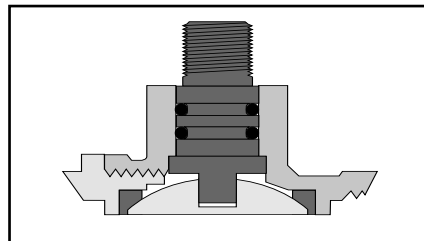

Anti extrusion stem

The BVGL series ball valves are fitted with an anti extrusion stem to prevent blow out in the case of pressure peaks. The stem is sealed with two Fluorocarbon O-rings for maximum safety and performance.

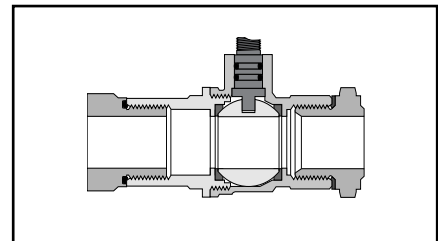

Full flow

All BVGL series valves are full-flow. This limits the turbulence created by the passage of fluid across the valve, minimizing pressure drop.

BVGL BSPP Female/Female Valve with Lever Handle

PART NO.	DN MM	THREAD BSPP	C	H	L	L1	O
BVG4-1/4L	8	1/4	20	38	50	82	25.0
BVG4-3/8L	10	3/8	20	38	60	82	25.0
BVG4-1/2L	15	1/2	25	43	75	100	32.5
BVG4-3/4L	20	3/4	32	50	80	120	39.0
BVG4-1L	25	1	41	54	90	120	47.5
BVG4-1.1/4L	32	1 1/4	50	73	110	158	59.0
BVG4-1.1/2L	40	1 1/2	55	79	120	158	71.5
BVG4-2L	50	2	70	86	140	158	86.0

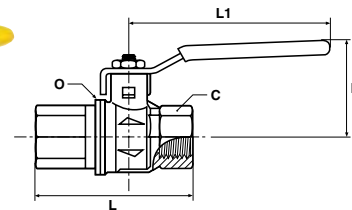

BVGT4 BSPP Female/Female Valve with Compact Handle

PART NO.	DN MM	THREAD BSPP	C	H	L	L1	O
BVGT4-1/4L	8	1/4	20	39	50	50	25.0
BVGT4-3/8L	10	3/8	20	39	60	50	25.0
BVGT4-1/2L	15	1/2	25	43	75	50	32.5
BVGT4-3/4L	20	3/4	32	47	80	60	39.0
BVGT4-1L	25	1	41	51	90	60	47.5

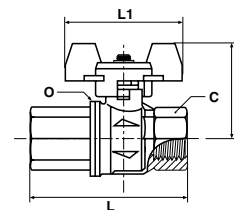



Parker Metric Ball Valve Series BVGLOCK

MATERIALS OF CONSTRUCTION	
VALVE BODY:	BRASS NICKEL PLATED TO DIN 17660 AND UNI 5705
BALL:	BRASS CHROME PLATED
SEATS / SEALS:	PTFE WITH SILICONE FREE LUBRICANT
PACKING GLAND:	PTFE
HANDLE:	CARBON STEEL

SPECIFICATIONS	
MEETS THE REQUIREMENTS OF EUROPEAN DIRECTIVE DI 89/392/CEE RELATING TO THE ISOLATION OF POWER SUPPLY AND TO MEET THE HEALTH AND SAFETY REQUIREMENTS FOR MACHINES AND MATERIALS IN PARAGRAPHS L233-5 OF THE CODE DU TRAVAIL.	



Operating pressures and temperatures

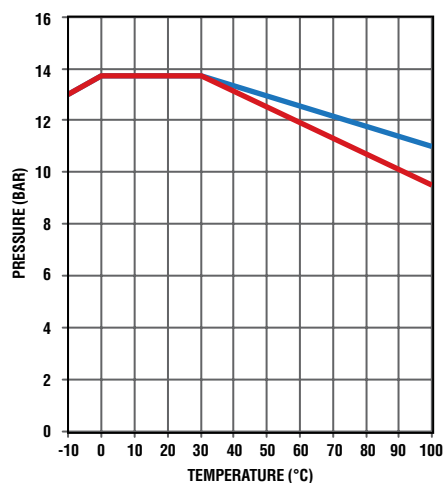

■ 1/4" to 1/2"
■ 3/4" to 2"

N.B. This chart gives general information. Only testing under operating conditions will finally determine which valve should be selected.

K

Advantages

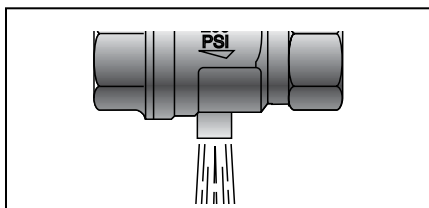

Threaded Exhaust

BVGPLOCK series ball valves are manufactured with an exhaust port, this safety feature enables the downstream air pressure to be vented when the valve is closed. 1/4-1" have M5 thread. 1.1/4 and larger are not threaded.

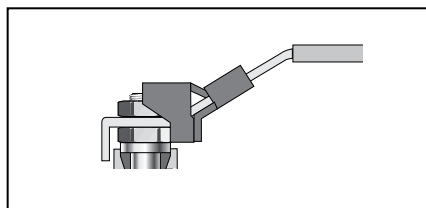

Lockable Handle

The BVGPLOCK series ball valves are fitted with a handle that can be locked in the closed position with a padlock. This safety feature ensures the valve cannot be accidentally opened, and only authorized personnel can operate the valve. Sizes 1.1/4 and larger can be locked in both the open and closed positions.

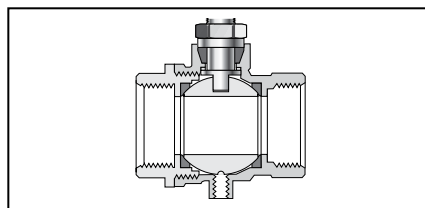

DIN 2999 / ISO 228 Female Threads

BVGPLOCK series valves are manufactured with long female threads in accordance to DIN2999/ISO228. This enables the valves to be used with Prestolok, Metrulok and brass adaptors but also Parker's range of steel hydraulic fittings and EO-fittings form "A" or "C" to DIN 3852.

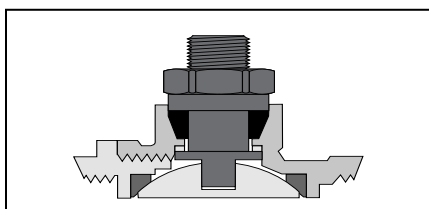

Anti Extrusion Stem

The BVGPLOCK series ball valves are fitted with an anti-extrusion stem to prevent blow out in the case of pressure peaks.

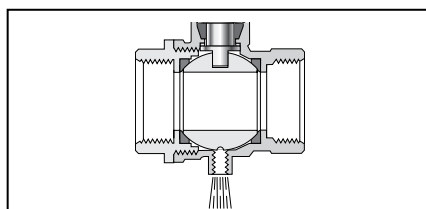

Full Flow

All BVGPLOCK series valves are full-flow. This limits the turbulence created by the passage of fluid across the valve, minimizing pressure drop.

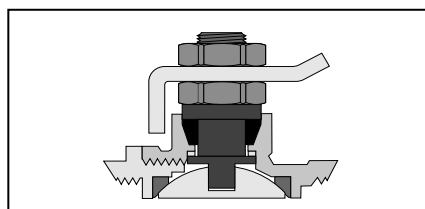

Adjustable Packing

The PTFE packing gland and adjustable washer are designed to give longer service life and lower operating torques.

BVG4PLOCK BSPP Female/Female, Vented, Locking Handle

PART NO.	D FLOW Ø	THREAD BSPP	C	G	H	I	L	L1
BVG4P-1/4 LOCK	8.0	1/4	20	22.5	47.5	12.0	45	96
BVG4P-3/8 LOCK	9.5	3/8	20	22.5	47.5	12.0	45	96
BVG4P-1/2 LOCK	15.0	1/2	25	29.5	52.0	15.5	59	96
BVG4P-3/4 LOCK	19.0	3/4	31	32.0	59.5	17.0	64	117
BVG4P-1 LOCK	24.0	1	40	40.5	63.5	21.0	81	117
BVG4P-1.1/4LOCK	32.0	1-1/4	49	46.5	76.5	23.0	93	158
BVG4P-1.1/2LOCK	40.0	1-1/2	54	51.0	82.5	23.0	102	158
BVG4P-2LOCK	50.0	2	69	60.5	89.5	26.5	121	158

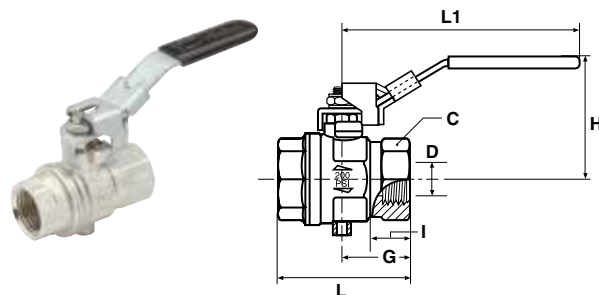



Parker Metric Ball Valve Series MBVG

MATERIALS OF CONSTRUCTION	
VALVE BODY:	BRASS CHROMIUM PLATED
BALL:	BRASS CHROME PLATED
SEATS/SEALS:	PTFE
STEM SEAL:	FLUOROCARBON
HANDLE:	POLYAMIDE



Operating pressures and temperatures

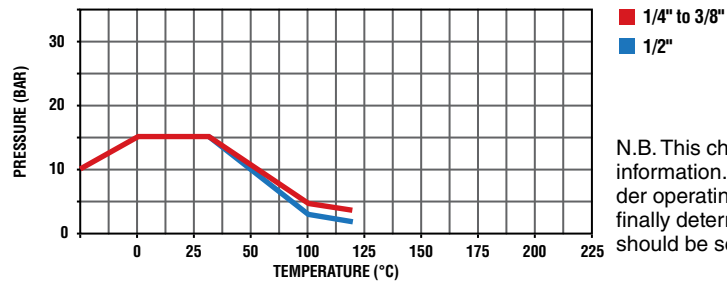

N.B. This chart gives general information. Only testing under operating conditions will finally determine which valve should be selected.

K

Advantages

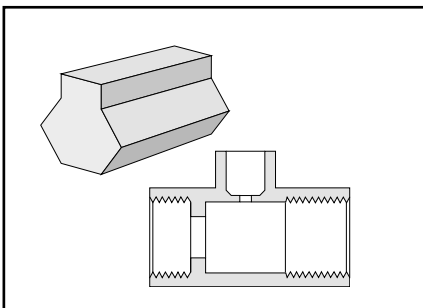

Design of the body

The valve is manufactured from a solid section which incorporates the stem housing in the body. This design allows excellent guidance of the stem, which increases its lifespan.

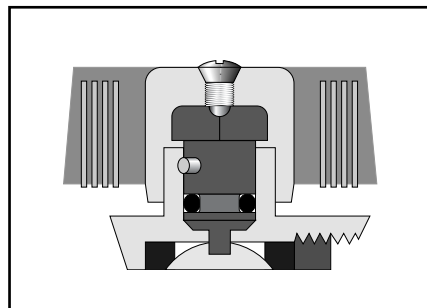

Stem tightness

A Fluorocarbon O-Ring assembled under compression automatically compensates for minute friction wear. Thus a high standard of seal is attained.

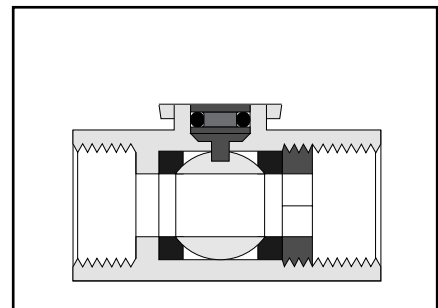

Tightness of the seals

The perfect tightness of the seals on the casing is obtained by the preset force of the nut, adjusted during assembly.

MBVG BSPP Female/Female Valve

PART NO.	DN MM	THREAD BSPP	C	H	L	L1
MBVG4-1/4	8	1/4	21	31.5	41.5	39
MBVG4-3/8	8	3/8	21	31.5	41.5	39
MBVG4-1/2	10	1/2	25	33.5	48.0	39

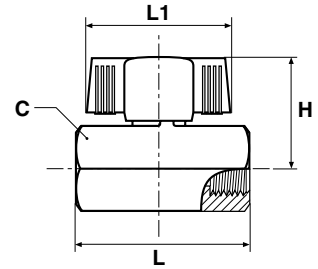



Micro Ball Valves Series 708/709

MATERIALS OF CONSTRUCTION	
VALVE BODY:	BRASS
BALL:	BRASS CHROME PLATED
SEATS/SEALS:	PTFE
STEM SEAL:	NITRILE
HANDLE:	CHROME PLATED STEEL

SPECIFICATIONS	
PRESSURE RANGE	UP TO 500 PSI VACUUM SERVICE TO 29" OF HG
TEMPERATURE RANGE	-35° TO +300°F
OPERATING INSTRUCTIONS	Quarter turn is "ON" or "OFF" (Provides positive stop action for full shutoff.)

STYLE	TYPE	SIZE
MV	708 / 709	-2, -4
STYLE	MV-MICRO VALVE	
TYPE	708 - MALE / FEMALE 709 - FEMALE / FEMALE	
SIZE	4-1/4"	

FLOW DATA		
VALVE SIZE	MV708 CV	MV709 CV
1/4	.95	.95



Parker's industrial ball valve product line is intended for general purpose use. Please be aware that ball valves are intended for use in the fully open or closed positions. Depending on application conditions, throttling of the valve may result in premature seal failure and / or inability to turn the valve handle.

K

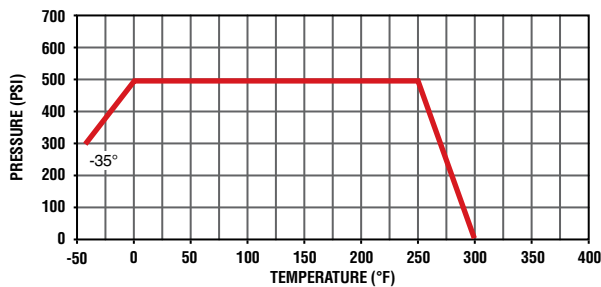

Male-Female Pipe Ends, Mini Ball Valve MV708

PART NO.	PIPE THREAD	B HEX	H	L	M	N	P	FLOW DIA. D
MV708-2	1/8	9/16	1.18	.63	1.62	.93	.38	.180
MV708-4	1/4	11/16	1.52	.70	1.57	.79	.50	.210

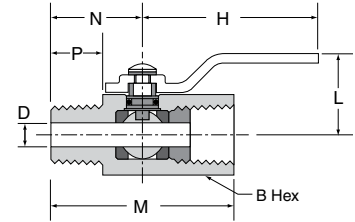

Female Pipe Ends, Mini Ball Valve MV709

PART NO.	PIPE THREAD	B HEX	H	L	M	N	FLOW DIA. D
MV709-2	1/8	9/16	1.18	.63	1.52	.68	.180
MV709-4	1/4	11/16	1.52	.70	1.57	.76	.210

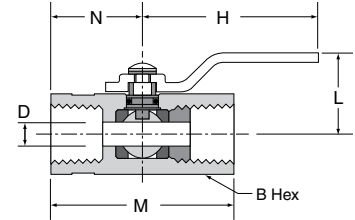

Replacement Handles

	VALVE	PLATED STEEL LEVER W/COVER	S.S. LEVER (NO COVER)	S.S. LEVER W/COVER	TEE (NO COVER)	OVAL (W/COVER)	SHORT LEVER (NO COVER)	PLATED STEEL LKG. LEVER W/COVER	S.S. LOCKING LEVER W/COVER
XV500P (501, 502, 506, 510, 590, 591)	-4	2560-10082	2566-00105		2566-00147	2566-00215	2566-00231	2560-10080	2560-10081
	-6	2560-10082	2566-00105		2566-00147	2566-00215	2566-00231	2560-10080	2560-10081
	-8	2560-10082	2566-00105		2566-00147	2566-00215	2566-00231	2560-10080	2560-10081
	-10	2560-10097	2566-00178		2566-00179			2566-10100	
	-12	2560-10097	2566-00178		2566-00179	2566-00180	—	2560-10100	2560-10101
	-16	2560-10097	2566-00178		2566-00179	2566-00180	—	2560-10100	2560-10101
	-20	2566-00143	2566-00153		2566-00281	—	2566-00142	2566-00135	—
	-24	2566-00143	2566-00153		2566-00281	—	2566-00142	2566-00135	—
	-32	2566-00143	2566-00153		2566-00281	—	2566-00142	2566-00135	—
XV501SS & XV502SS	-4	—		2566-00132	—	2566-00108	2566-00146	—	2566-00138
	-6	—		2566-00132	—	2566-00108	2566-00146	—	2566-00138
	-8	—		2566-00132	—	2566-00108	2566-00146	—	2566-00138
	-12	—		2566-00133	—	2566-00109	—	—	2566-00184
	-16	—		2566-00133	—	2566-00109	—	—	2566-00184
XV502SS	-20	—		2566-00134	—	2566-00110	—	—	2566-00185
	-24	—		2566-00134	—	2566-00110	—	—	2566-00185
	-32	—		2566-00134	—	2566-00110	—	—	2566-00185
XV500CS & XV502CS	-4	2566-00158			2566-00170	2566-00166		2566-00162	
	-6	2566-00158			2566-00170	2566-00166		2566-00162	
	-8	2566-00158			2566-00171	2566-00166		2566-00162	
	-12	2566-00159			2566-00172	2566-00167		2566-00163	
	-16	2566-00159			2566-00172	2566-00167		2566-00163	
	-20	2566-00160				2566-00168		2566-00164	
	-24	2566-00160				2566-00168		2566-00164	
XV506CS	-4	2566-00158			2566-00170	2566-00166		2566-00162	
	-6	2566-00158			2566-00170	2566-00166		2566-00162	
	-8							2566-00234	
	-12	—						2566-00235	
	-16	—						2566-00236	
XV533P	-4	2560-10152	2566-00105		2566-00147	2566-00215	2566-00231	2560-10160	
	-6	2560-10152	2566-00105		2566-00147	2566-00215	2566-00231	2560-10160	
	-8	2560-10152	2566-00105		2566-00147	2566-00215	2566-00231	2560-10160	
	-12	2560-10153	2566-00178		2566-00179	2566-00180		2560-10168	
	-16	2560-10153	2566-00178		2566-00179	2566-00180		2560-10168	
XV520P	-4				2566-00277			2566-00262	
	-6				2566-00277			2566-00262	
	-8				2566-00277			2566-00262	
	-12				2566-00280			2566-00261	
	-16				2566-00280			2566-00261	
	-20	2566-00143	2566-00153		2566-00281			2566-00135	
	-24	2566-00143	2566-00153		2566-00281			2566-00135	
	-32	2566-00143	2566-00153		2566-00281			2566-00135	
	40	2566-00253							
48	2566-00253								
XV500HP, XV506HP, XV507HP	-4							BVHPLK-1 ^A	
	-6							BVHPLK-1 ^A	
	-8							BVHPLK-1 ^A	
	-12							BVHPLK-2 ^A	
	-16							BVHPLK-2 ^A	
	-20							BVHPLK-3 ^A	
	-24							BVHPLK-3 ^A	
-32							BVHPLK-3 ^A		

^A Locking kit for use with standard handles



Replacement Handle Nuts

VALVE	PLATED STEEL	STAINLESS STEEL
XV500P-4	2567-00020	2567-00023
XV500P-6	2567-00020	2567-00023
XV500P-8	2567-00020	2567-00023
XV500P-12	2567-00055	2567-00057
XV500P-16	2567-00055	2567-00057
XV500P-20	2567-00051	2567-00052
XV500P-24	2567-00051	2567-00052
XV500P-32	2567-00051	2567-00052

Replacement Handle Covers

VALVE	LEVER	SHORT LEVER	TEE
XV500P-4	2569-00108	2569-00342	2569-00155
XV500P-6	2569-00108	2569-00342	2569-00155
XV500P-8	2569-00108	2569-00342	2569-00155
XV500P-12	2569-00296		2569-00155
XV500P-16	2569-00296		2569-00155
XV500P-20	2569-00229	2569-00234	
XV500P-24	2569-00229	2569-00234	
XV500P-32	2569-00229	2569-00234	
XV502SS-4		2569-00203	
XV502SS-6		2569-00203	
XV502SS-8		2569-00203	

STX	Stem Extension Kit
P	For use on Brass Ball Valves
1	1: 1/4" thru 1/2" valves 2: 3/4" thru 1" valves
125	125: 1-1/4" extension length 225: 2-1/4" extension length

STX	Stem Extension Kit
SS	For use on Stainless Steel Ball Valves
1	1: 1/4" thru 1/2" valves 2: 3/4" thru 1" valves 3: 1-1/4"-2" valves
125	125: 1-1/4" extension length 225: 2-1/4" extension length

All stem extension kit componentry is made from high quality, corrosion resistant stainless steel

Note: Stem extensions cannot be used with series 509 and series 520.

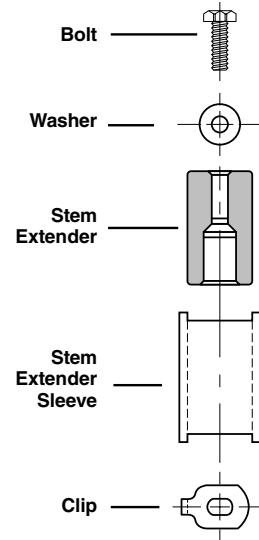

Brass Valve Extension Dimensions STX-P-1-125

PART NO.	VALVE SIZE	B HEX	C HEX	H	L	M	N	D FLOW Ø
STX-P-1-125	1/4	15/16	15/16	3.96	4.96	2.03	3.73	.375
STX-P-1-125	3/8	15/16	15/16	3.96	4.96	2.03	3.73	.375
STX-P-1-125	1/2	1-1/16	1-1/16	3.96	5.05	2.20	3.84	.500
STX-P-2-125	3/4	1-1/4	1-5/16	3.96	5.25	2.42	4.06	.685
STX-P-2-125	1	1-1/2	1-9/16	3.96	5.89	2.75	4.33	.875

Note: Drawing shows STX-P assembled to XV500P series-not included

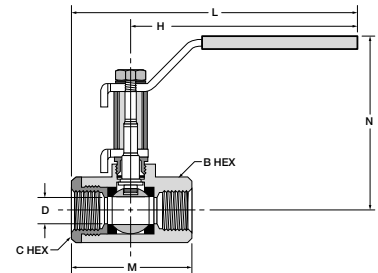

K

Brass Valve Extension Dimensions STX-P-1-225

PART NO.	VALVE SIZE	B HEX	C HEX	H	L	M	N	D FLOW Ø
STX-P-1-225	1/4	15/16	15/16	3.96	4.96	2.03	4.73	.375
STX-P-1-225	3/8	15/16	15/16	3.96	4.96	2.03	4.73	.375
STX-P-1-225	1/2	1-1/16	1-1/16	3.96	5.05	2.20	4.84	.500
STX-P-2-225	3/4	1-1/4	1-5/16	3.96	5.25	2.42	5.06	.685
STX-P-2-225	1	1-1/2	1-9/16	3.96	5.89	2.75	5.33	.875

Note: Drawing shows STX-P assembled to XV500P series-not included

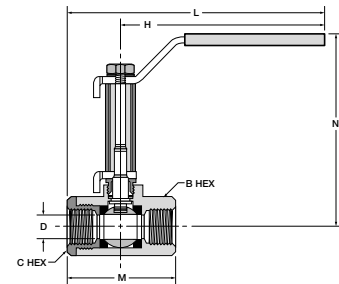



Mini Ball Valves

Series 200/608/609

MATERIALS OF CONSTRUCTION	
VALVE BODY:	BRASS CHROME PLATED
BALL:	BRASS CHROME PLATED
SEATS/SEALS:	PTFE
STEM SEAL:	FLUOROCARBON
HANDLE:	608/609 - POLYAMIDE WEDGE 200 - POLYAMIDE LEVER

MV200 PRESSURE AND TEMPERATURE RANGE	
PRESSURE RANGE	200 PSI
TEMPERATURE RANGE	0° TO +200°F

MV 608/609 PRESSURE AND TEMPERATURE RANGE	
PRESSURE RANGE	450 PSI
TEMPERATURE RANGE	0° TO +200°F



STYLE	TYPE	SIZE
MV	608 / 609	-2
STYLE	MV-MINI VALVE	
TYPE	608 - MALE / FEMALE 609 - FEMALE / FEMALE	
HANDLE COLOR	MV200 FEATURES A BLACK LEVER HANDLE MV608/MV609 FEATURES-YELLOW WEDGE HANDLES	
SIZE	2-1/8", 4-1/4", 6-3/8", 8-1/2"	

Parker's industrial ball valve product line is intended for general purpose use. Please be aware that ball valves are intended for use in the fully open or closed positions. Depending on application conditions, throttling of the valve may result in premature seal failure and/or inability to turn the valve handle.

STYLE	TYPE	SIZE
MV	200	-2
STYLE	MV-MINI VALVE	
TYPE	200 - FEMALE / FEMALE LEVER HANDLE	
SIZE	2-1/8", 4-1/4", 6-3/8", 8-1/2"	

For use on water and air service lines on capital equipment and plant design plumbing that require total shutoff capability.

FLOW DATA			
VALVE SIZE	MV200 CV	MV608 CV	MV609 CV
1/8	1.3	1.2	1.4
1/4	4.0	5.8	4.3
3/8	3.7	3.9	3.6
1/2	5.8	5.6	6.0

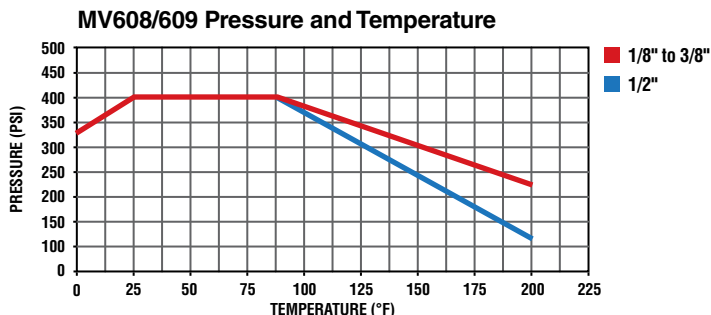
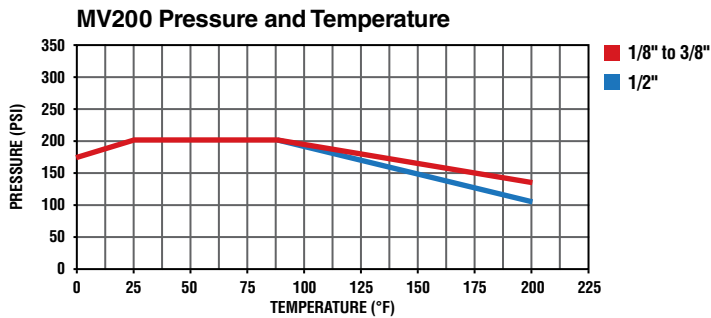

SPECIFICATIONS	
OPERATING INSTRUCTIONS	QUARTER TURN IS "ON" OR "OFF" (PROVIDES POSITIVE STOP ACTION FOR FULL SHUTOFF.)



**Female Pipe Ends, Lever Handle,
Mini Ball Valve MV200**

PART NO.	PIPE THREAD	HEX	B	C	H	L	FLOW DIA. D
MV200-2	1/8	.83	1.71	1.20	.91	2.83	.31
MV200-4	1/4	.83	1.71	1.20	.91	2.83	.31
MV200-6	3/8	.83	1.71	1.20	.91	2.83	.31
MV200-8	1/2	.98	2.11	1.28	1.10	2.83	.39

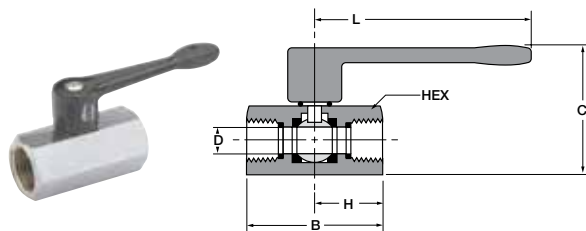

**Male-Female Pipe Ends, Compact Handle,
Mini Ball Valve MV608**

PART NO.	PIPE THREAD	A HEX	B	C	FLOW DIA. D
MV608-2	1/8	.83	1.72	1.22	.20
MV608-4	1/4	.83	1.72	1.22	.31
MV608-6	3/8	.83	1.72	1.22	.31
MV608-8	1/2	.98	2.11	1.30	.39

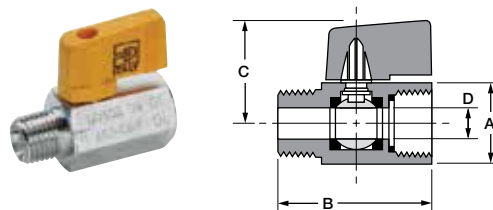

**Female Pipe Ends, Compact Handle,
Mini Ball Valve MV609**

PART NO.	PIPE THREAD	A HEX	B	C	FLOW DIA. D
MV609-2	1/8	.83	1.71	1.22	.24
MV609-4	1/4	.83	1.71	1.22	.31
MV609-6	3/8	.83	1.71	1.22	.31
MV609-8	1/2	.98	2.11	1.30	.39
MV609-6-4	3/8X1/4	.83	1.71	1.22	.31

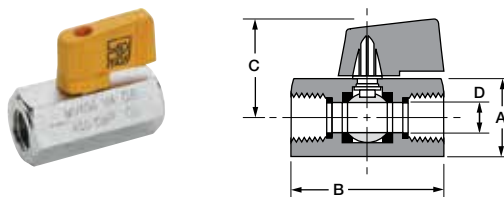



Plug Valves Series PV

MATERIALS OF CONSTRUCTION	
VALVE BODY:	BRASS
VALVE STEM:	ACETAL

NOMENCLATURE	
EXAMPLE: PV607-2-OPTIONS	ATTRIBUTE:
PV	PLUG VALVE
607	MALE TO MALE
2	1/8" MALE
N (NOT SHOWN)	NEOPRENE (BROWN)
V (NOT SHOWN)	FLOROCARBON (RED)

SPECIFICATIONS	
PRESSURE RANGE	UP TO 250 PSI
TEMPERATURE RANGE	-40° TO +175°F



Compact design features internal nitrile seats and a one-piece extruded brass body, offering compatibility with a wide range of media. The one-piece stem/handle combination is constructed of glass reinforced acetal copolymer. All plug valves are 100% leak tested and are certified to be leak free to one SCCM.

Installation Instructions

To assure sealability and reliable performance, the valve must be installed so that the flow media travels in the direction of the arrow on the valve handle.

Valve Components

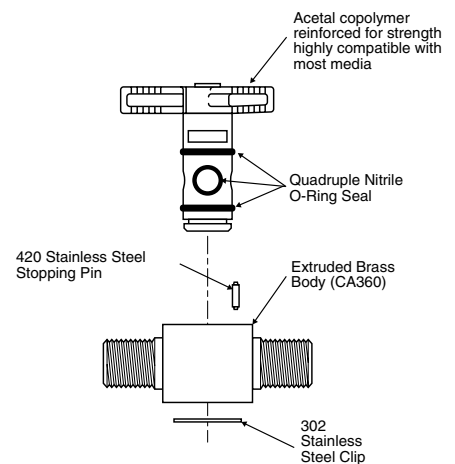

Male Pipe to Male Pipe Plug Valve PV607

PART NO.	PIPE THREAD	H	L	M	N	N1	FLOW DIA. D
PV607-2	1/8	.67	1.34	1.66	1.38	.51	.200
PV607-4	1/4	.67	1.34	2.02	1.38	.51	.200

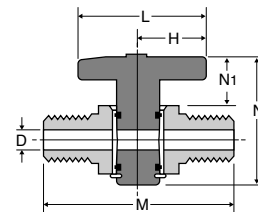

Female Pipe to Male Pipe Plug Valve PV608

PART NO.	PIPE THREAD	H	L	M	N	N1	FLOW DIA. D
PV608-2	1/8	.67	1.34	1.67	1.38	.51	.200
PV608-4	1/4	.67	1.34	2.06	1.38	.51	.200

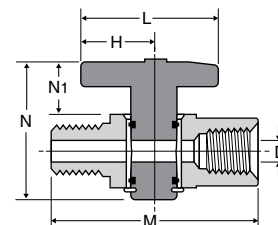

Female Pipe to Female Pipe Plug Valve PV609

PART NO.	PIPE THREAD	H	L	M	N	N1	FLOW DIA. D
PV609-2	1/8	.67	1.34	1.68	1.38	.51	.200
PV609-4	1/4	.67	1.34	2.10	1.38	.51	.200

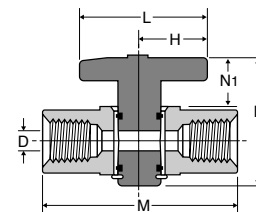

Mounting Bracket PVMB-001

PART NO.	H	M	N	N1	D
PVMB-001	.68	1.86	.90	.45	.135

Note: 1" diameter hole required in panel when using mounting bracket

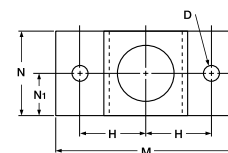



Needle Valves

MATERIALS OF CONSTRUCTION	
VALVE BODY:	BRASS
STEM:	BRASS

NEEDLE VALVE NOMENCLATURE	
EXAMPLE: NV101F-4-2	ATTRIBUTE:
NV	NEEDLE VALVE
101	ANGLE NEEDLE VALVE
F	FLARED TO MALE PIPE
4	1/4" TUBE O.D.
2	1/8" PIPE THREAD

SPECIFICATIONS	
PRESSURE RANGE	VALVES UP TO 150 PSI UNLESS OTHERWISE NOTED
TEMPERATURE RANGE	SEE SPECIFIC PART NUMBER FOR TEMPERATURE RANGE



Needle valves have metal-to-metal seats with fine thread screwdown. Brass construction with specially formulated low temperature seal which remains elastic to temperature as low -40°F.

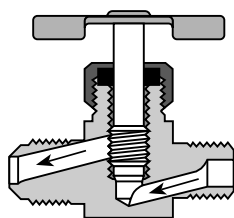

Needle Valves Installation Instructions

Series NV valves should always be installed with the pressure against the seat. Refer to drawing to determine correct direction of flow.



Angle Needle Valve NV101F

Flare to Male Pipe
Temperature Range: -45° to +250° F

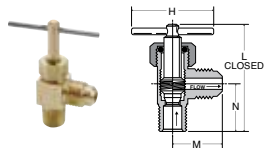

PART NO.	TUBE SIZE	PIPE THREAD	H	L	M	N
NV101F-4-2	1/4	1/8	1.50	1.58	.75	.66
NV101F-6-4	3/8	1/4	1.38	1.86	.95	.90

Needle Valve NV102F

Flare to Flare *Provided with Pin Handle
Temperature Range: -45° to +250° F

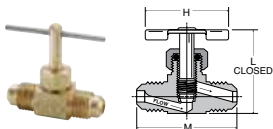

PART NO.	TUBE SIZE	H	L	M
NV102F-4*	1/4	1.50	1.34	1.50
NV102F-6	3/8	1.38	1.55	1.86

Needle Valve NV103F

Flare to Male Pipe *Provided with Pin Handle
Temperature Range: -45° to +250° F

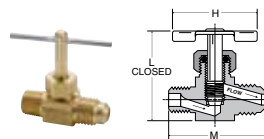

PART NO.	TUBE SIZE	PIPE THREAD	H	L	M
NV103F-4-2*	1/4	1/8	1.50	1.33	1.35
NV103F-6-4	3/8	1/4	1.38	1.56	1.73

Humidifier Valve HV104C

Temperature Range: -45° to +250° F

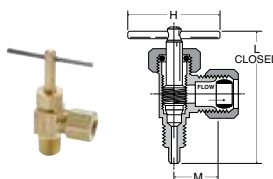

PART NO.	TUBE SIZE	PIPE THREAD	H	L	M
HV104C-4-2	1/4	1/8	1.50	1.89	.53

Humidifier Valve clamp kit HV104C-kit

Temperature Range: -30° to +250° F
Clamp fits 3/8" O.D. through 1.315" O.D. tube or pipe.
Kit includes 60PT-4 and 63PT-4 for assembly with plastic or nylon tubing. For complete kit, specify entire part number as shown below:

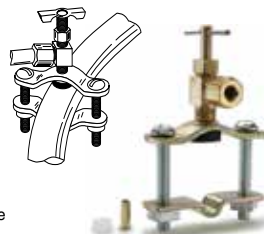

PART NO.	TUBE SIZE	PIPE THREAD
HV104C-4-2 KIT	1/4	1/8

Self-Piercing Humidifier Valve clamp kit SPV104C-kit

Temperature Range: -30° to +250° F
Clamp fits 3/8" O.D. through 1.315" O.D. tube or pipe. Kit includes 60PT-4 and 63PT-4 for assembly with plastic or nylon tubing. For complete kit, specify entire part number as shown below:

Plastic sleeve and brass insert for 1/4" O.D. x .040 wall plastic tubing
Brass sleeve for 1/4" O.D. copper tube

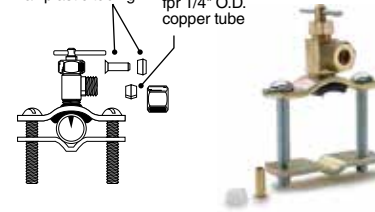

PART NO.	TUBE SIZE	PIPE THREAD
SPV104C KIT	1/4	1/8

Angle Needle Valve NV104C-NV104CA

Compression to Male Pipe *Provided with Pin Handle
Temperature Range: -45° to +250° F

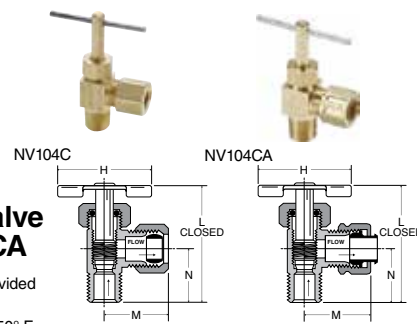

PART NO.	TUBE SIZE	PIPE THREAD	H	L	M	N
NV104C-4-2*	1/4	1/8	1.50	1.54	.88	.67
NV104CA-4-2*	1/4	1/8	1.50	1.49	.77	.66
NV104C-4-4	1/4	1/4	1.38	1.80	.93	.75
NV104C-5-2*	5/16	1/8	1.50	1.63	.88	.68
NV104C-6-4	3/8	1/4	1.38	1.76	.94	.81

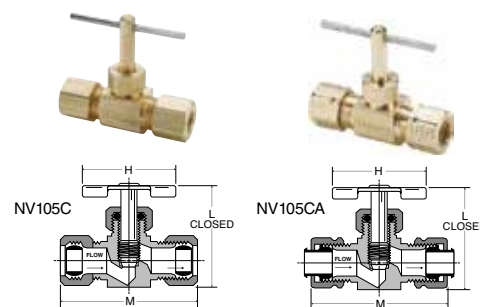

Needle Valve NV105C-NV105CA

Compression to Compression
*Provided with Pin Handle
Temperature Range: -45° to +250° F

PART NO.	TUBE SIZE	H	L	M
NV105C-4*	1/4	1.50	1.41	1.75
NV105C-5*	5/16	1.50	1.35	1.73
NV105C-6	3/8	1.38	1.55	1.93
NV105CA-4*	1/4	1.50	1.41	1.64
NV105CA-6	3/8	1.38	1.55	1.78

K

Needle Valve NV106C-NV106CA

Compression to Male Pipe
 *Provided with Pin Handle
 Temperature Range: -45° to +250° F

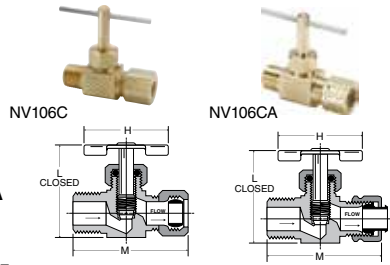

PART NO.	TUBE SIZE	PIPE THREAD	H	L	M
NV106C-4-2*	1/4	1/8	1.50	1.41	1.53
NV106C-4-4*	1/4	1/4	1.50	1.40	1.55
NV106C-5-2*	5/16	1/8	1.50	1.35	1.50
NV106C-6-4	3/8	1/4	1.38	1.56	1.75
NV106CA-4-2	1/4	1/8	1.50	1.41	1.47
NV106CA-4-4*	1/4	1/4	1.50	1.33	1.52
NV106CA-6-4	3/8	1/4	1.38	1.53	1.78

Needle Valve NV107P

Male Pipe to Male Pipe
 *Provided with Pin Handle
 Temperature Range: -45° to +250° F

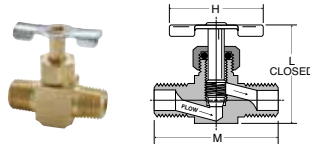

PART NO.	PIPE THREAD	H	L	M
NV107P-2*	1/8	1.50	1.35	1.25
NV107P-4	1/4	1.38	1.54	1.65

Needle Valve NV108P

Female Pipe to Male Pipe
 *Provided with Pin Handle
 Temperature Range: -45° to +250° F

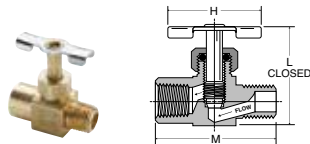

PART NO.	PIPE THREAD	H	L	M
NV108P-2*	1/8	1.50	1.36	1.25
NV108P-4	1/4	1.38	1.56	1.61

Needle Valve NV109P

Female Pipe to Female Pipe
 *Provided with Pin Handle
 Temperature Range: -45° to +250° F

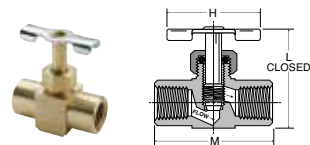

PART NO.	PIPE THREAD	H	L	M
NV109P-2*	1/8	1.50	1.35	1.25
NV109P-4	1/4	1.38	1.53	1.60

Needle Valve NV311P

Poly-Tite to Male Pipe
 Temperature Range: 0° to +150° F

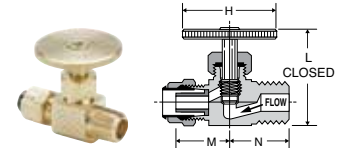

PART NO.	TUBE SIZE	PIPE THREAD	H	L	M	N
NV311P-4-2	1/4	1/8	1.07	1.17	.50	.63
NV311P-4-4	1/4	1/4	1.07	1.18	.50	.72
NV311P-6-4	3/8	1/4	1.07	1.19	.56	.72

Angle Needle Valve NV312P

Poly-Tite to Male Pipe
 Temperature Range: 0° to +150° F

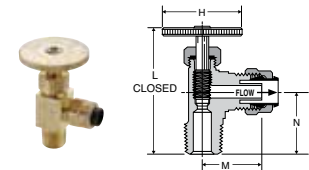

PART NO.	TUBE SIZE	PIPE THREAD	H	L	M	N
NV312P-4-2	1/4	1/8	1.07	1.53	.48	.68
NV312P-4-4	1/4	1/4	1.07	1.72	.56	.86
NV312P-6-4	3/8	1/4	1.07	1.68	.64	.86





Drain Cocks/ Ground Plug Shutoff

DRAIN COCK NOMENCLATURE	
EXAMPLE: DC604-2	ATTRIBUTE:
DC	DRAIN COCK
604	EXTERNAL SEAT
2	1/8 PIPE THREAD

GROUND PLUG SHUTOFF NOMENCLATURE	
EXAMPLE: V204F-4-2	ATTRIBUTE:
V	VALVE
204	FLARED TO MALE PIPE
F	FLARED
4	1/4 TUBE O.D.
2	1/8 PIPE THREAD

SPECIFICATIONS	
GROUND PLUG SHUTOFF:	30 PSI
DRAIN COCKS	150 PSI
TEMPERATURE RANGES:	SEE SPECIFIC PART NUMBER FOR TEMPERATURE RANGE
OPERATING FLUID:	AIR, WATER, GAS AND CERTAIN OTHER FLUIDS.
NOTE:	LUBRICANT MAY NOT BE COMPATIBLE WITH SOME FLUIDS, CONTACT FACTORY FOR SPECIAL FLUID REQUIREMENTS



Drain cocks are manufactured in both external and internal seats. Ground plug shutoffs are manufactured from castings or forged bodies for extra strength. Hand tightening provides a metal - to - metal seal.

Ground Plug Shutoff V203F

Flare to Flare
Temperature Range: +32° to +125° F

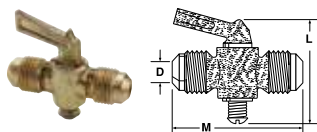

PART NO.	TUBE SIZE	L	M	FLOW DIA. D
V203F-6-6	3/8	2.26	2.13	.220
V203F-8-8	1/2	2.26	2.50	.281

Ground Plug Shutoff V204F

Flare to Male Pipe
Temperature Range: +32° to +125° F

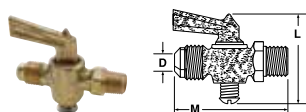

PART NO.	TUBE SIZE	PIPE THREAD	L	M	FLOW DIA. D
V204F-4-2	1/4	1/8	1.85	2.00	.188
V204F-6-4	3/8	1/4	1.85	2.18	.218

Ground Plug Shutoff V303C / V303CA

Compression to Compression
Temperature Range: +32° to +125° F

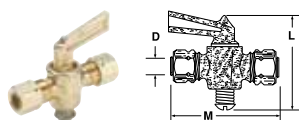

PART NO.	TUBE SIZE	L	M	FLOW DIA. D
V303C-4-4	1/4	1.88	2.33	.188
V303CA-4-4	1/4	1.90	1.75	.188
V303C-6-6	3/8	2.26	2.45	.218
V303CA-6-6	3/8	1.76	1.60	.218

Ground Plug Shutoff V304C / V304CA

Compression to Male Pipe
Temperature Range: +32° to +125° F

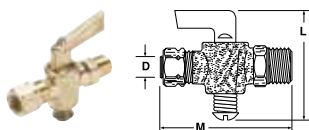

PART NO.	TUBE SIZE	PIPE THREAD	L	M	FLOW DIA. D
V304C-4-2	1/4	1/8	1.90	2.29	.188
V304CA-4-2	1/4	1/8	1.88	2.00	.188
V304C-4-4	1/4	1/4	1.90	2.15	.188
V304C-6-4	3/8	1/4	1.83	2.24	.218
V304CA-6-4	3/8	1/4	1.83	2.11	.218

Ground Plug Shutoff V401P

Male Pipe to Male Pipe
Temperature Range: +32° to +125° F

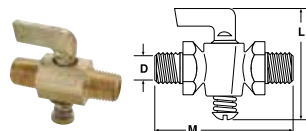

PART NO.	PIPE THREAD	L	M	FLOW DIA. D
V401P-2-2	1/8	1.90	2.25	.188
V401P-4-4	1/4	1.90	1.98	.188

Ground Plug Shutoff V402P

Female Pipe to Male Pipe
Temperature Range: +32° to +125° F

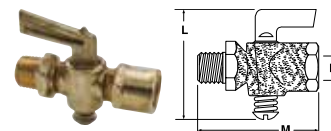

PART NO.	FEMALE PIPE THREAD	PIPE THREAD	L	M	FLOW DIA. D
V402P-2-2	1/8	1/8	1.85	1.78	.218
V402P-4-4	1/4	1/4	1.86	2.26	.218
V402P-6-6	3/8	3/8	2.34	2.21	.245

Ground Plug Shutoff V403P

Female Pipe to Female Pipe
Temperature Range: +32° to +125° F

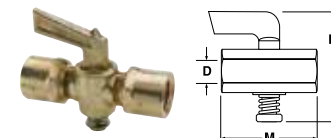

PART NO.	FEMALE PIPE THREAD	L	M	FLOW DIA. D
V403P-2-2	1/8	1.90	1.51	.218
V403P-4-4	1/4	1.90	1.65	.188
V403P-6-6*	3/8	2.25	2.00	.250

*Made from extruded bar stock

Three-way valve V406P

Female Pipe three ends
Temperature Range: -40° to +180° F

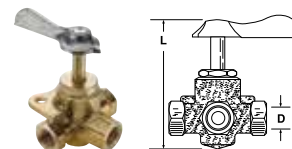

PART NO.	PIPE THREAD	L	FLOW DIA. D
V406P-4	1/4	3.10	.281

Four-way valve V407P

Female Pipe four ends
Temperature Range: -40° to +180° F

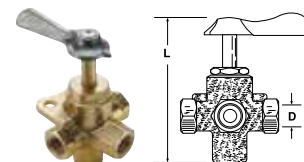

PART NO.	PIPE THREAD	L	FLOW DIA. D
V407P-4	1/4	3.30	.281

Ground Plug Shutoff DC601

Temperature Range: +32° to +125° F

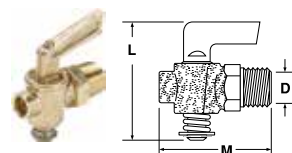

PART NO.	PIPE THREAD	L	M	FLOW DIA. D
DC601-2	1/8	1.90	1.40	.170
DC601-4	1/4	1.90	1.52	.170
DC601-6	3/8	2.26	1.74	.281
DC601-8	1/2	2.29	1.82	.281



Drain Cock DCR601

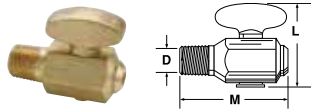

Temperature Range: -30° to +250° F

PART NO.	PIPE THREAD	L	M	FLOW DIA. D
DCR601-4	1/4	1.41	1.73	.156

Internal Seal Drain Cock DC602

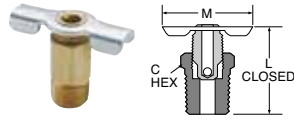

Temperature Range: -65° to +250° F

PART NO.	PIPE THREAD	C HEX	L	M
DC602-2	1/8	13/32	.92	1.25
DC602-4	1/4	9/16	.94	1.25

Drain Cock DC603

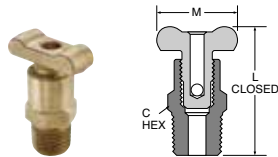

Temperature Range: -65° to +250° F

PART NO.	PIPE THREAD	C HEX	L	M
DC603-2	1/8	5/8	1.41	1.00
DC603-4	1/4	5/8	1.54	1.16
DC603-6	3/8	11/16	1.63	1.16

External Seal Drain Cock DC604

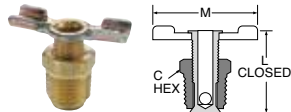

Temperature Range: -25° to +250° F

PART NO.	PIPE THREAD	C HEX	L	M
DC604-2*	1/8	7/16	.85	1.25
DC604-4	1/4	9/16	1.00	1.38
DC604-6*	3/8	11/16	1.22	1.68

*When assembled handle wings are down facing

External Seal Drain Cock DC606

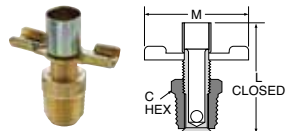

Temperature Range: -65° to +250° F

PART NO.	PIPE THREAD	C HEX	L	M
DC606-4	1/4-18	9/16	1.50	1.38

Bib Drain Valve DC607

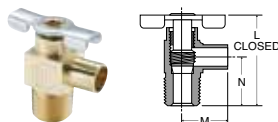

Temperature Range: -65° to +250° F

PART NO.	HOSE SIZE	PIPE THREAD	FLOW	L	M	N
DC607-4	3/8	1/4	.31	1.32	.67	.71

K