

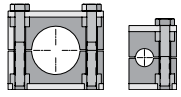













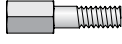
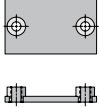
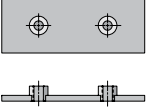

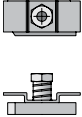

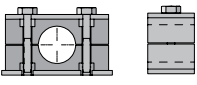



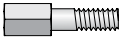
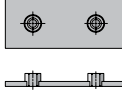

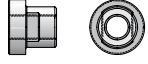
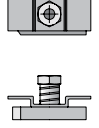

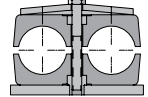

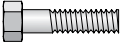
## ParKlamp Inch Tube Clamps

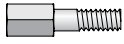
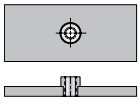
0

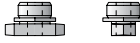
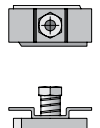
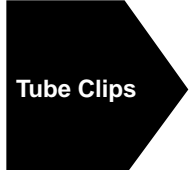
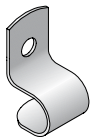
|  |   |   |   |   |  |
|--|---|---|---|---|--|
|  <p><b>Standard Series</b></p>                        | <p><b>Clamp Halves</b></p>  <p>O6</p>              | <p><b>CP</b><br/>Cover Plate</p>  <p>O7</p>                | <p><b>BCP</b><br/>Hexagon Head Bolt for Cover Plate</p>  <p>O7</p>     | <p><b>IPS</b><br/>Insert</p>  <p>O7</p>                              | <p><b>BIP</b><br/>Hexagon Head Bolt for Insert</p>  <p>O7</p> |
| <p><b>LP</b><br/>Locking Plate</p>  <p>O7</p>         | <p><b>SB</b><br/>Stacking Bolt</p>  <p>O7</p>      | <p><b>WP</b><br/>Weld Plate</p>  <p>O8</p>                 | <p><b>WPE</b><br/>Weld Plate Elongated</p>  <p>O8</p>                  | <p><b>R</b><br/>Mounting Rail</p>  <p>O8</p>                         | <p><b>HRN</b><br/>Hexagon Rail Nut</p>  <p>O8</p>             |
| <p><b>CRA</b><br/>Channel Rail Adapter</p>  <p>O8</p> |  <p><b>Heavy Series</b></p>                        | <p><b>Clamp Halves Heavy</b></p>  <p>O9</p>                | <p><b>CPH</b><br/>Cover Plate Heavy</p>  <p>O10</p>                    | <p><b>BCPH</b><br/>Hexagon Head Bolt for Cover Plate</p>  <p>O10</p> | <p><b>LPH</b><br/>Locking Plate Heavy</p>  <p>O10</p>         |
| <p><b>SBH</b><br/>Stacking Bolt Heavy</p>  <p>O10</p> | <p><b>WPH</b><br/>Weld Plate Heavy</p>  <p>O10</p> | <p><b>RH</b><br/>Mounting Rail Heavy</p>  <p>O11</p>       | <p><b>RNH</b><br/>Mounting Rail Nut Heavy</p>  <p>O11</p>              | <p><b>CRA</b><br/>Channel Rail Adapter</p>  <p>O11</p>              |  |
|  <p><b>Twin Series</b></p>                          | <p><b>Clamp Halves</b></p>  <p>O12</p>           | <p><b>CPT</b><br/>Cover Plate</p>  <p>O13</p>            | <p><b>BCPT</b><br/>Hexagon Head Bolt for Cover Plate</p>  <p>O13</p> | <p><b>LPT</b><br/>Locking Plate</p>  <p>O13</p>                    | <p><b>SBT</b><br/>Stacking Bolt</p>  <p>O13</p>             |
| <p><b>WPT</b><br/>Weld Plate Twin</p>  <p>O14</p>   | <p><b>R</b><br/>Mounting Rail</p>  <p>O14</p>    | <p><b>RNT</b><br/>Mounting Rail Nut Twin</p>  <p>O14</p> | <p><b>CRA</b><br/>Channel Rail Adapter</p>  <p>O14</p>               |  <p><b>Tube Clips</b></p>  | <p><b>Tube Clip</b><br/>3121-1</p>  <p>O15</p>              |
| <p><b>Tube Clip</b><br/>3121-3</p>  <p>O15</p>      | <p><b>Tube Clip</b><br/>3121-4</p>  <p>O15</p>   |   |   |   |  |

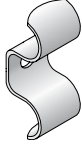
## Introduction

The ParKlamp system is designed for restraining tube, pipe and hose assemblies against unwanted and potentially harmful effects of mechanical shock and vibration forces that are common in fluid power systems.

The clamping system is the most commonly overlooked aspect of fluid power system design. Failure to properly restrain the fluid conductors can result in leakage, downtime and system malfunction, as well as significantly reduce the life of tube, pipe and hose assemblies. With the ParKlamp system, the risk of problems resulting from mechanical shock and vibration can be significantly reduced.

## Design and Construction

Designed to meet the basic envelope dimensions of DIN 3015, Part 1, the ParKlamp plastic clamp halves are interchangeable with the Parker metric clamp system. The primary difference between these two clamping systems is the utilization of inch, as opposed to metric, thread hardware in the ParKlamp system. All plastic clamp halves in the ParKlamp system are manufactured from Polypropylene material. The hardware portion of the ParKlamp system is available in plated steel and stainless steel.

For convenience, the ParKlamp system is divided into three different series: Standard, Heavy and Twin. Each series has corresponding components, physical dimensions and mechanical properties. Within each series, there are a number of groups, each with specific envelope dimensions. Components from different series and/or groups can not be intermixed. However, the standard and twin series can be mounting on the same mounting rail.

## How It Works

The ParKlamp system has two primary methods for mounting: weld plates and mounting rails.

**Clamps should be mounted to a rigid structure for optimum performance. Clamping tube, pipe or hose assemblies together without mounting them to a rigid structure, often called "floating clamps," does not provide adequate support.**

**Proper design of a clamping system requires that the clamps be positioned appropriately on the tube, pipe or hose assemblies. See the Assembly and Installation section of this catalog for more information on clamp location and spacing.**

### Weld Plate Mounting (Fig. O1)

The weld plate mounting system allows the user to attach a single clamp assembly to a structure of similar material (steel to steel, etc) by welding the components together. Once the weld plate is attached to a structure, one clamp half can be placed onto the weld plate, followed by the tube, pipe or hose assembly. Next, the second plastic clamp half can be placed on the tube, pipe or hose assembly, followed by the cover plate (or Insert). To complete the assembly, the Hex Head attachment bolts are inserted into the assembly and tightened to the torque shown in the Assembly section of this catalog.



Fig. O1 – Weld Plate Assembly



Fig. O2 – Mounting Rail Assembly

## Assembly and Installation

Please refer to Section S for the assembly and installation instructions for ParKlamp Inch Tube Clamps.

### Mounting Rail Mounting (Fig. O2)

Use of a mounting rail is another way to assemble the clamping system components onto a support structure. Using a mounting rail allows multiple clamps to be mounted side-by-side for restraining a group of tube, pipe, or hose assemblies. The mounting rail also provides the ability to move the location of the clamps in one direction for easier alignment. The rail can be attached to a support structure by welding or bolting. Once the mounting rail is in place, rail nuts can be slid into the rail. The first clamp half, followed by the tube, pipe or hose assembly, can then be installed over the corresponding rail nuts. After this, the second clamp half, the cover plate (or Insert) and the hex head attachment bolts can be installed to complete the assembly.

### Stacking (Fig. O3)

A primary feature of the ParKlamp system is its ability to accommodate stacking of a series of clamps to various heights, thus requiring a smaller footprint for mounting. To do this, simply use the stacking bolts to mount the first clamp assembly, then install a stacking plate over the first clamp and stacking bolts. The second clamp assembly can then be placed over the first clamp assembly. Complete the mounting by assembling a cover plate and using the hex head bolts to tighten the upper clamp assembly. **Note: When stacking, the clamps must be from the same series and group.**

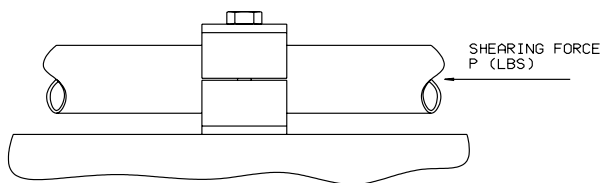

Fig. O3 – Stacked Assembly

## Shearing Force Diagram

The forces shown in these diagrams represent the resistance to sliding provided by the clamps in the axial direction.

The sliding starts when the shown values are reached.



| STANDARD SERIES |                   |                                 |   |   |     |
|-----------------|-------------------|---------------------------------|---|---|-----|
| Clamp Group     | Hexagon Head Bolt | Polypropylene                   |   |   |     |
|                 |                   | Tightening torque [Nm]<br>Ft/lb |   | Max. load in pipe direction<br>F [kN] lbf |     |
| 1               |                   | 8                               | 6 | 0,6                                       | 135 |
| 1A              |                   | 8                               | 6 | 1,1                                       | 247 |
| 2               | M6 / 1/4"-20      | 8                               | 6 | 1,3                                       | 292 |
| 3               | UNC               | 8                               | 6 | 1,4                                       | 315 |
| 4               |                   | 8                               | 6 | 1,5                                       | 337 |
| 5               |                   | 8                               | 6 | 1,9                                       | 427 |
| 6               |                   | 8                               | 6 | 2,0                                       | 450 |

| HEAVY SERIES |                   |                                 |    |   |       |
|--------------|-------------------|---------------------------------|----|---|-------|
| Clamp Group  | Hexagon Head Bolt | Polypropylene                   |    |   |       |
|              |                   | Tightening torque [Nm]<br>Ft/lb |    | Max. load in pipe direction<br>F [kN] lbf |       |
| 3S           | M10 / 3/8"-       | 12                              | 9  | 1,6                                       | 360   |
| 4S           | 16 UNC            | 12                              | 9  | 2,9                                       | 652   |
| 5S           | M12 / 7/16" -     | 15                              | 11 | 3,3                                       | 742   |
| 6S           | 14 UNC            | 30                              | 12 | 8,2                                       | 1.843 |

## Clamp Body Material Properties

|                              | Polypropylene PP       |
|------------------------------|------------------------|
| <b>MECHANICAL PROPERTIES</b> |                        |
| Density                      | .901g/cc               |
| Tensile Strength             | 25 MPa<br>(4,000 psi)  |
| Flexural Modulus             | 1073 MPa               |
| Compressive Strength         | 90MPa<br>(23,050 psi)  |
| (Resistance)                 |                        |
| Notched IZOD Impact Strength | 3.1 KJ/mm <sup>2</sup> |

|                              | Polypropylene PP       |
|------------------------------|------------------------|
| <b>THERMAL PROPERTIES</b>    |                        |
| Max. Temperature             | -30° to +90° C         |
| Resistance                   | -22° to +194°F         |
| <b>ELECTRICAL PROPERTIES</b> |                        |
| Specific Volume              |                        |
| Resistivity Ohm x Inch       | 3.9 x 10 <sup>17</sup> |
| <b>CHEMICAL PROPERTIES</b>   |                        |
| Light Acids, Solvents        | Stable                 |
| Fuels, Mineral Oils          | Stable                 |
| Alcohol, Paints, Saltwater   | Stable                 |

# How to Order ParKlamp Kits

Select a symbol from Box 1 and pair it with a symbol from Box 2 to create a part number for the kit.

**Example:** Weld Plate Kit – Twin Series for 3/4" tube.

| Box 1 | Box 2 |
|-------|-------|
| WPT   | 3190  |

| Box 1 : Mounting – Assembly Type |  |
|----------------------------------|--|
| Symbol                           | Description                                |
| WP                               | Weld Plate Kit – Standard Series           |
| WPH                              | Weld Plate Kit – Heavy Series              |
| WPE                              | Elongated Weld Plate Kit – Standard Series |
| WPT                              | Weld Plate Kit – Twin Series               |
| RN                               | Rail Nut Kit – Standard Series             |
| RNH                              | Rail Nut Kit – Heavy Series                |
| RNT                              | Rail Nut Kit – Twin Series                 |
| SA                               | Stacked Assembly Kit – Standard Series     |
| SAH                              | Stacked Assembly Kit – Heavy Series        |
| SAT                              | Stacked Assembly Kit – Twin Series         |

| Box 2: Clamp Half – Size/Type Designation |        |            |                         |
|---|--------|------------|-------------------------|
| Symbol                                    | Size   | Type       | Series                  |
| 1064                                      | 1/4"   | Tube       | Standard – Twin         |
| 1064A                                     | 1/4"   | Tube       | Standard                |
| 3134H                                     | 1/4"   | 100R1 Hose | Standard                |
| 4150H                                     | 1/4"   | 100R2 Hose | Heavy                   |
| 1095                                      | 3/8"   | Tube       | Standard – Twin         |
| 3095                                      | 3/8"   | Tube       | Heavy                   |
| 1095A                                     | 3/8"   | Tube       | Standard                |
| 3174H                                     | 3/8"   | 100R1 Hose | Standard                |
| 4198H                                     | 3/8"   | 100R2 Hose | Heavy                   |
| 2127                                      | 1/2"   | Tube       | Standard                |
| 3127                                      | 1/2"   | Tube       | Heavy                   |
| 3205H                                     | 1/2"   | 100R1 Hose | Standard                |
| 4221H                                     | 1/2"   | 100R2 Hose | Heavy                   |
| 3213                                      | 1/2"   | Pipe       | Standard                |
| 4213                                      | 1/2"   | Pipe       | Heavy                   |
| 2160                                      | 5/8"   | Tube       | Standard – Twin         |
| 3160                                      | 5/8"   | Tube       | Heavy                   |
| 3239H                                     | 5/8"   | 100R1 Hose | Standard                |
| 4251H                                     | 5/8"   | 100R2 Hose | Heavy                   |
| 3190                                      | 3/4"   | Tube       | Standard – Twin         |
| 4190                                      | 3/4"   | Tube       | Heavy                   |
| 5278H                                     | 3/4"   | 100R1 Hose | Standard                |
| 4292H                                     | 3/4"   | 100R2 Hose | Heavy                   |
| 4266                                      | 3/4"   | Pipe       | Standard – Twin         |
| 4267                                      | 3/4"   | Pipe       | Heavy                   |
| 3254                                      | 1"     | Tube       | Standard – Twin         |
| 4254                                      | 1"     | Tube       | Heavy                   |
| 5357H                                     | 1"     | 100R1 Hose | Standard                |
| 6378H                                     | 1"     | 100R2 Hose | Heavy                   |
| 5334                                      | 1"     | Pipe       | Standard – Heavy – Twin |
| 5320                                      | 1 1/4" | Tube       | Standard – Heavy – Twin |
| 5438H                                     | 1 1/4" | 100R1 Hose | Standard                |
| 6484H                                     | 1 1/4" | 100R2 Hose | Heavy                   |
| 5422                                      | 1 1/4" | Pipe       | Heavy                   |
| 5381                                      | 1 1/2" | Tube       | Standard – Heavy – Twin |
| 6498H                                     | 1 1/2" | 100R1 Hose | Standard                |
| 6544H                                     | 1 1/2" | 100R2 Hose | Heavy                   |
| 6483                                      | 1 1/2" | Pipe       | Standard – Heavy        |
| 6508                                      | 2"     | Tube       | Standard – Heavy        |
| 6603                                      | 2"     | Pipe       | Heavy                   |
| 6635                                      | 2 1/2" | Tube       | Heavy                   |
| 7762                                      | 3"     | Tube       | Heavy                   |



Weld Plate Kit



Mounting Rail Kit



Stacked Assembly Kit

Dimensions and pressures for reference only, subject to change.

# Clamp Halves

Standard Series

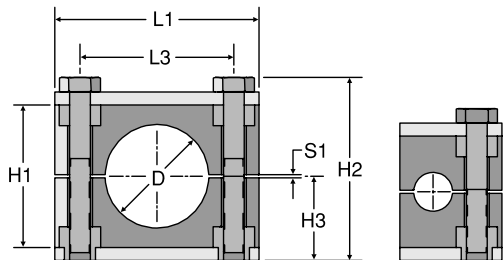

Groups 1A, 2, 3, 4, 5 and 6      Group 1

See note below

| TUBE CLAMP HALVES |           |         |      |      |      |      |      |      |      |      |                     |
|-------------------|-----------|---------|------|------|------|------|------|------|------|------|---------------------|
| PART #            | TUBE SIZE | GROUP # | D    |      | H1   | H2   | H3   | L1   | L3   | S1   | STANDARD FROM STOCK |
|                   |           |         | in.  | mm   | in.  | in.  | in.  | in.  | in.  | in.  |                     |
| 1064-PP           | 1/4       | 1       | 0.25 | 6.4  | 1.06 | 1.45 | 0.65 | 1.02 | NA   | 0.01 | •                   |
| 1095-PP           | 3/8       | 1       | 0.38 | 9.5  | 1.06 | 1.45 | 0.65 | 1.02 | NA   | 0.01 | •                   |
| 1064A-PP          | 1/4       | 1A      | 0.25 | 6.4  | 1.06 | 1.45 | 0.65 | 1.45 | 0.78 | 0.01 | •                   |
| 1095A-PP          | 3/8       | 1A      | 0.38 | 9.5  | 1.06 | 1.45 | 0.65 | 1.45 | 0.78 | 0.01 | •                   |
| 2127-PP           | 1/2       | 2       | 0.50 | 12.7 | 1.29 | 1.69 | 0.77 | 1.65 | 1.02 | 0.01 | •                   |
| 2160-PP           | 5/8       | 2       | 0.63 | 16.0 | 1.29 | 1.69 | 0.77 | 1.65 | 1.02 | 0.01 | •                   |
| 3190-PP           | 3/4       | 3       | 0.75 | 19.0 | 1.41 | 1.77 | 0.80 | 1.96 | 1.29 | 0.01 | •                   |
| 3254-PP           | 1         | 3       | 1.00 | 25.4 | 1.41 | 1.77 | 0.80 | 1.96 | 1.29 | 0.01 | •                   |
| 5320-PP           | 1 1/4     | 5       | 1.25 | 32.0 | 2.28 | 2.72 | 1.28 | 2.79 | 2.04 | 0.03 | •                   |
| 5381-PP           | 1 1/2     | 5       | 1.50 | 38.1 | 2.28 | 2.72 | 1.28 | 2.79 | 2.04 | 0.03 | •                   |
| 6508-PP           | 2         | 6       | 2.00 | 50.8 | 2.59 | 3.00 | 1.42 | 3.38 | 2.59 | 0.03 | •                   |

| PIPE CLAMP HALVES |           |         |      |      |      |      |      |      |      |      |                     |
|-------------------|-----------|---------|------|------|------|------|------|------|------|------|---------------------|
| PART #            | PIPE SIZE | GROUP # | D    |      | H1   | H2   | H3   | L1   | L3   | S1   | STANDARD FROM STOCK |
|                   |           |         | in.  | mm   | in.  | in.  | in.  | in.  | in.  | in.  |                     |
| 3213-PP           | 1/2       | 3       | 0.84 | 21.3 | 1.41 | 1.77 | 0.80 | 1.96 | 1.29 | 0.01 | •                   |
| 4266-PP           | 3/4       | 4       | 1.05 | 26.6 | 1.65 | 2.09 | 0.96 | 2.32 | 1.57 | 0.01 | •                   |
| 5334-PP           | 1         | 5       | 1.31 | 33.4 | 2.28 | 2.72 | 1.28 | 2.79 | 2.04 | 0.03 | •                   |
| 6483-PP           | 1 1/2     | 6       | 1.90 | 48.3 | 2.59 | 3.00 | 1.42 | 3.38 | 2.59 | 0.03 | •                   |

| 100R1 HOSE CLAMP HALVES |           |         |      |      |      |      |      |      |      |      |                     |
|-------------------------|-----------|---------|------|------|------|------|------|------|------|------|---------------------|
| PART #                  | HOSE SIZE | GROUP # | D    |      | H1   | H2   | H3   | L1   | L3   | S1   | STANDARD FROM STOCK |
|                         |           |         | in.  | mm   | in.  | in.  | in.  | in.  | in.  | in.  |                     |
| H3134PP                 | 1/4       | 3       | 0.53 | 13.4 | 1.41 | 1.77 | 0.80 | 1.96 | 1.29 | 0.01 | •                   |
| H3174PP                 | 3/8       | 3       | 0.69 | 17.4 | 1.41 | 1.77 | 0.80 | 1.96 | 1.29 | 0.01 | •                   |
| H3205PP                 | 1/2       | 3       | 0.81 | 20.5 | 1.41 | 1.77 | 0.80 | 1.96 | 1.29 | 0.01 | •                   |
| H3239PP                 | 5/8       | 3       | 0.94 | 23.9 | 1.41 | 1.77 | 0.80 | 1.96 | 1.29 | 0.01 | •                   |
| H5278PP                 | 3/4       | 5       | 1.09 | 27.8 | 2.28 | 2.72 | 1.28 | 2.79 | 2.04 | 0.03 | •                   |
| H5357PP                 | 1         | 5       | 1.41 | 35.7 | 2.28 | 2.72 | 1.28 | 2.79 | 2.04 | 0.03 | •                   |
| H5438PP                 | 1 1/4     | 5       | 1.72 | 43.8 | 2.28 | 2.72 | 1.28 | 2.79 | 2.04 | 0.03 | •                   |
| H6498PP                 | 1 1/2     | 6       | 1.96 | 49.8 | 2.59 | 3.00 | 1.42 | 3.38 | 2.59 | 0.03 | •                   |

**Note:** One clamp set includes two identical halves of polypropylene. Tube and pipe clamp halves are black in color. Hose clamp halves are green in color. Hardware shown in the illustrations above is **not** included.

Other sizes available. Please contact TFD for a quote.

Dimensions and pressures for reference only, subject to change.



**CP**  
Cover Plate

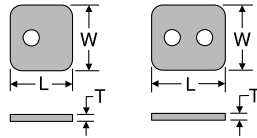

| TUBE FITTING PART # | GROUP # | L LENGTH (in.) | W WIDTH (in.) | T THICKNESS (in.) | STANDARD FROM STOCK |     |
|---------------------|---------|----------------|---------------|-------------------|---------------------|-----|
|                     |         |                |               |                   | -S                  | -SS |
| CP-1                | 1       | 1.10           | 1.18          | 0.11              | •                   | •   |
| CP-1A               | 1A      | 1.33           | 1.18          | 0.11              | •                   | •   |
| CP-2                | 2       | 1.59           | 1.18          | 0.11              | •                   | •   |
| CP-3                | 3       | 1.88           | 1.18          | 0.11              | •                   | •   |
| CP-4                | 4       | 2.24           | 1.18          | 0.11              | •                   | •   |
| CP-5                | 5       | 2.75           | 1.18          | 0.11              | •                   | •   |
| CP-6                | 6       | 3.38           | 1.18          | 0.11              | •                   | •   |

**Material:** Steel: Zinc nickel plated  
SS: 316 stainless steel

**BCP**  
Hexagon Head Bolt for Cover Plate  
(2 required for Groups 1A-6)

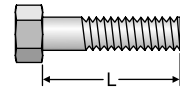

| TUBE FITTING PART # | GROUP # | L LENGTH (in.) | STANDARD FROM STOCK |     |
|---------------------|---------|----------------|---------------------|-----|
|                     |         |                | -S                  | -SS |
| BCP-1               | 1       | 1.25           | •                   | •   |
| BCP-1A              | 1A      | 1.25           | •                   | •   |
| BCP-2               | 2       | 1.38           | •                   | •   |
| BCP-3               | 3       | 1.50           | •                   | •   |
| BCP-4               | 4       | 1.88           | •                   | •   |
| BCP-5               | 5       | 2.38           | •                   | •   |
| BCP-6               | 6       | 2.75           | •                   | •   |

**Note:** Bolt threads are 1/4 - 20 UNC, Grade 5, zinc clear chromate plated  
**Material:** SS: 316 stainless steel

**IPS**  
Insert

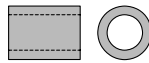

| TUBE FITTING PART # | STANDARD FROM STOCK |
|---------------------|---------------------|
| IPS                 | •                   |

**Material:** Plastic  
One size fits all groups (2 required for Groups 1A - 6).  
(Use when not using a cover plate.)

**BIP**  
Hexagon Head Bolt for Insert

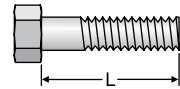

| TUBE FITTING PART # | GROUP # | L LENGTH (in.) | STANDARD FROM STOCK |
|---------------------|---------|----------------|---------------------|
| BIP-1               | 1       | 1.13           | •                   |
| BIP-1A              | 1A      | 1.13           | •                   |
| BIP-2               | 2       | 1.38           | •                   |
| BIP-3               | 3       | 1.38           | •                   |
| BIP-4               | 4       | 1.63           | •                   |
| BIP-5               | 5       | 2.38           | •                   |
| BIP-6               | 6       | 2.75           | •                   |

**Note:** Bolt threads are 1/4 - 20 UNC, Grade 5, zinc clear chromate plated

**LP**  
Locking Plate

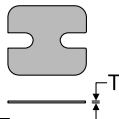

| TUBE FITTING PART # | GROUP # | T THICKNESS (in.) | STANDARD FROM STOCK |
|---------------------|---------|-------------------|---------------------|
| LP-1                | 1       | 0.03              | •                   |
| LP-1A               | 1A      | 0.03              | •                   |
| LP-2                | 2       | 0.03              | •                   |
| LP-3                | 3       | 0.03              | •                   |
| LP-4                | 4       | 0.03              | •                   |
| LP-5                | 5       | 0.03              | •                   |
| LP-6                | 6       | 0.03              | •                   |

**Material:** Steel, zinc nickel plated

**SB**  
Stacking Bolt  
(2 required for Groups 1A-6)

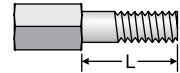

| TUBE FITTING PART # | GROUP # | L LENGTH (in.) | STANDARD FROM STOCK |
|---------------------|---------|----------------|---------------------|
| SB-1                | 1       | 0.78           | •                   |
| SB-1A               | 1A      | 0.78           | •                   |
| SB-2                | 2       | 1.00           | •                   |
| SB-3                | 3       | 1.18           | •                   |
| SB-4                | 4       | 1.38           | •                   |
| SB-5                | 5       | 1.96           | •                   |
| SB-6                | 6       | 2.36           | •                   |

**Note:** Bolt threads are 1/4 - 20 UNC, 1010 steel, zinc nickel plated

Dimensions and pressures for reference only, subject to change.

**WP**  
Weld Plate

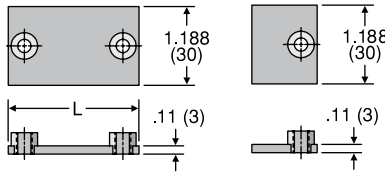

| TUBE FITTING PART # | GROUP # | L LENGTH |      | STANDARD FROM STOCK |     |
|---------------------|---------|----------|------|---------------------|-----|
|                     |         | (in.)    | (mm) | -S                  | -SS |
| WP-1                | 1       | 1.25     | 31.5 | •                   | •   |
| WP-1A               | 1A      | 1.41     | 36   | •                   | •   |
| WP-2                | 2       | 1.65     | 42   | •                   | •   |
| WP-3                | 3       | 1.96     | 50   | •                   | •   |
| WP-4                | 4       | 2.36     | 60   | •                   | •   |
| WP-5                | 5       | 2.79     | 71   | •                   | •   |
| WP-6                | 6       | 3.46     | 88   | •                   | •   |

**Material:** Steel: 1020 steel, zinc-phosphate plated  
SS: 316 stainless steel

**WPE**  
Weld Plate Elongated

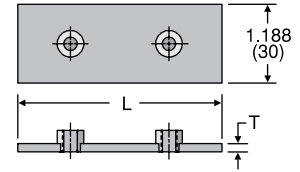

| TUBE FITTING PART # | GROUP # | L LENGTH |      | T THICKNESS | STANDARD FROM STOCK |
|---------------------|---------|----------|------|-------------|---------------------|
|                     |         | (in.)    | (mm) | (in.)       |                     |
| WPE-1               | 1       | 2.28     | 58   | 0.11        | •                   |
| WPE-1A              | 1A      | 2.51     | 64   | 0.11        | •                   |
| WPE-2               | 2       | 2.75     | 70   | 0.11        | •                   |
| WPE-3               | 3       | 3.07     | 78   | 0.11        | •                   |
| WPE-4               | 4       | 3.42     | 87   | 0.11        | •                   |
| WPE-5               | 5       | 3.93     | 100  | 0.11        | •                   |
| WPE-6               | 6       | 4.52     | 115  | 0.11        | •                   |

**Material:** 1020 steel, zinc-phosphate plated

**R**  
Mounting Rail

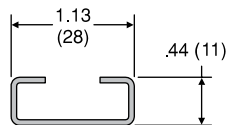

| TUBE FITTING PART # | LENGTH              | STANDARD FROM STOCK |     |
|---------------------|---------------------|---------------------|-----|
|                     |                     | -S                  | -SS |
| R-1                 | 3.28 ft. (1 meter)  | •                   | •   |
| R-2                 | 6.56 ft. (2 meters) | •                   | •   |

**Material:** Steel: Unplated  
SS: 316 stainless steel

**HRN**  
Hexagon Rail Nut

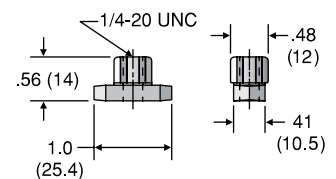

| TUBE FITTING PART # | STANDARD FROM STOCK |     |
|---------------------|---------------------|-----|
|                     | -S                  | -SS |
| HRN                 | •                   | •   |

**Material:** Steel: Zinc nickel plated  
SS: 316 stainless steel

Note: To be used with mounting rail (R)

**CRA**  
Channel Rail Adapter

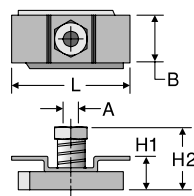

| TUBE FITTING PART # | THREAD "A" UNC | L in. (mm) | B in. (mm) | H1 in. (mm) | H2 in. (mm) | STANDARD FROM STOCK |
|---------------------|----------------|------------|------------|-------------|-------------|---------------------|
| CRA 1-8             | 1/4-20         | 1.37 (35)  | 0.74 (19)  | 0.51 (13)   | 0.77 (19.5) | •                   |

**Material:** Steel, zinc nickel plated

Dimensions and pressures for reference only, subject to change.

# Clamp Halves

Heavy Series

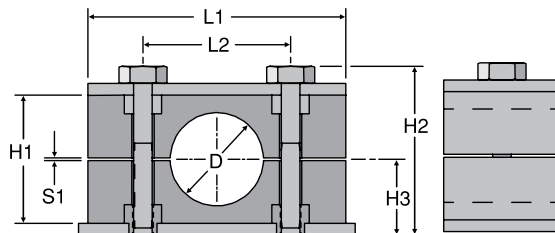

See note below

| TUBE CLAMP HALVES |           |         |       |      |          |          |          |          |          |          |                     |
|-------------------|-----------|---------|-------|------|----------|----------|----------|----------|----------|----------|---------------------|
| PART #            | TUBE SIZE | GROUP # | D     |      | H1 (in.) | H2 (in.) | H3 (in.) | L1 (in.) | L2 (in.) | S1 (in.) | STANDARD FROM STOCK |
|                   |           |         | (in.) | (mm) |          |          |          |          |          |          |                     |
| 3095-HPP          | 3/8       | H3      | 0.37  | 9.5  | 1.25     | 2.17     | 0.94     | 2.16     | 1.29     | 0.02     | •                   |
| 3127-HPP          | 1/2       | H3      | 0.50  | 12.7 | 1.25     | 2.17     | 0.94     | 2.16     | 1.29     | 0.02     | •                   |
| 3160-HPP          | 5/8       | H3      | 0.63  | 16.0 | 1.25     | 2.17     | 0.94     | 2.16     | 1.29     | 0.02     | •                   |
| 4190-HPP          | 3/4       | H4      | 0.75  | 19.0 | 1.88     | 2.80     | 1.26     | 2.75     | 1.77     | 0.02     | •                   |
| 4254-HPP          | 1         | H4      | 1.00  | 25.4 | 1.88     | 2.80     | 1.26     | 2.75     | 1.77     | 0.02     | •                   |
| 5320-HPP          | 1 1/4     | H5      | 1.25  | 32.0 | 2.36     | 3.27     | 1.50     | 3.34     | 2.36     | 0.02     | •                   |
| 5381-HPP          | 1 1/2     | H5      | 1.50  | 38.1 | 2.36     | 3.27     | 1.50     | 3.34     | 2.36     | 0.02     | •                   |
| 6508-HPP          | 2         | H6      | 2.00  | 50.8 | 3.50     | 4.61     | 2.17     | 4.52     | 3.54     | 0.07     | •                   |
| 6635-HPP          | 2 1/2     | H6      | 2.50  | 63.5 | 3.50     | 4.61     | 2.17     | 4.52     | 3.54     | 0.07     | •                   |
| 7762-HPP          | 3         | H7      | 3.00  | 76.2 | 4.72     | 5.74     | 2.75     | 5.98     | 4.80     | 0.07     | •                   |

| PIPE CLAMP HALVES |           |         |       |      |          |          |          |          |          |          |                     |
|-------------------|-----------|---------|-------|------|----------|----------|----------|----------|----------|----------|---------------------|
| PART #            | PIPE SIZE | GROUP # | D     |      | H1 (in.) | H2 (in.) | H3 (in.) | L1 (in.) | L2 (in.) | S1 (in.) | STANDARD FROM STOCK |
|                   |           |         | (in.) | (mm) |          |          |          |          |          |          |                     |
| 4213-HPP          | 1/2       | H4      | 0.84  | 21.3 | 1.88     | 2.80     | 1.26     | 2.75     | 1.77     | 0.02     | •                   |
| 4267-HPP          | 3/4       | H4      | 1.05  | 26.7 | 1.88     | 2.80     | 1.26     | 2.75     | 1.77     | 0.02     | •                   |
| 5334-HPP          | 1         | H5      | 1.31  | 33.4 | 2.36     | 3.27     | 1.50     | 3.34     | 2.36     | 0.02     | •                   |
| 5422-HPP          | 1 1/4     | H5      | 1.66  | 42.2 | 2.36     | 3.27     | 1.50     | 3.34     | 2.36     | 0.02     | •                   |
| 6483-HPP          | 1 1/2     | H6      | 1.90  | 48.3 | 3.50     | 4.61     | 2.17     | 4.52     | 3.54     | 0.07     | •                   |
| 6603-HPP          | 2         | H6      | 2.37  | 60.3 | 3.50     | 4.61     | 2.17     | 4.52     | 3.54     | 0.07     | •                   |

| 100R2 HOSE CLAMP HALVES |           |         |       |      |          |          |          |          |          |          |                     |
|-------------------------|-----------|---------|-------|------|----------|----------|----------|----------|----------|----------|---------------------|
| PART #                  | HOSE SIZE | GROUP # | D     |      | H1 (in.) | H2 (in.) | H3 (in.) | L1 (in.) | L2 (in.) | S1 (in.) | STANDARD FROM STOCK |
|                         |           |         | (in.) | (mm) |          |          |          |          |          |          |                     |
| H4150HPP                | 1/4       | H4      | 0.59  | 15.0 | 1.83     | 2.80     | 1.26     | 2.75     | 1.77     | 0.02     | •                   |
| H4198HPP                | 3/8       | H4      | 0.78  | 19.8 | 1.83     | 2.80     | 1.26     | 2.75     | 1.77     | 0.02     | •                   |
| H4221HPP                | 1/2       | H4      | 0.87  | 22.1 | 1.83     | 2.80     | 1.26     | 2.75     | 1.77     | 0.02     | •                   |
| H4251HPP                | 5/8       | H4      | 0.99  | 25.1 | 1.83     | 2.80     | 1.26     | 2.75     | 1.77     | 0.02     | •                   |
| H4292HPP                | 3/4       | H4      | 1.15  | 29.2 | 1.83     | 2.80     | 1.26     | 2.75     | 1.77     | 0.02     | •                   |
| H6378HPP                | 1         | H6      | 1.49  | 37.8 | 3.42     | 4.61     | 2.17     | 4.52     | 3.54     | 0.07     | •                   |
| H6484HPP                | 1 1/4     | H6      | 1.91  | 48.4 | 3.42     | 4.61     | 2.17     | 4.52     | 3.54     | 0.07     | •                   |
| H6544HPP                | 1 1/2     | H6      | 2.14  | 54.4 | 3.42     | 4.61     | 2.17     | 4.52     | 3.54     | 0.07     | •                   |

**Note:** One clamp set includes two identical halves of polypropylene. Tube and pipe clamps are black in color. Hose clamp halves are green in color. Hardware shown in the illustration above is **not** included.

Dimensions and pressures for reference only, subject to change.

### CPH

Cover Plate Heavy

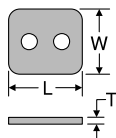

| TUBE FITTING PART # | GROUP # | L LENGTH (in.) | W WIDTH (in.) | T THICKNESS |      | STANDARD FROM STOCK |     |
|---------------------|---------|----------------|---------------|-------------|------|---------------------|-----|
|                     |         |                |               | (in.)       | (mm) | -S                  | -SS |
| CPH-3               | H3      | 2.16           | 1.18          | 0.31        | 8    | •                   | •   |
| CPH-4               | H4      | 2.75           | 1.18          | 0.31        | 8    | •                   | •   |
| CPH-5               | H5      | 3.34           | 1.18          | 0.31        | 8    | •                   | •   |
| CPH-6               | H6      | 4.52           | 1.77          | 0.39        | 10   | •                   | •   |
| CPH-7               | H7      | 5.98           | 2.36          | 0.39        | 10   | •                   | •   |

**Material:** Steel: Zinc phosphate plated  
SS: 316 stainless steel

### BCPH

Hexagon Head Bolt for Cover Plate  
(2 required per clamp set)

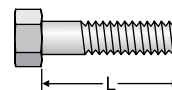

| TUBE FITTING PART # | GROUP # | L LENGTH (in.) | UNC THREAD | STANDARD FROM STOCK |     |
|---------------------|---------|----------------|------------|---------------------|-----|
|                     |         |                |            | -S                  | -SS |
| BCPH-3              | H3      | 1.75           | 3/8 - 16   | •                   | •   |
| BCPH-4              | H4      | 2.25           | 3/8 - 16   | •                   | •   |
| BCPH-5              | H5      | 2.75           | 3/8 - 16   | •                   | •   |
| BCPH-6              | H6      | 4.00           | 7/16 - 14  | •                   | •   |
| BCPH-7              | H7      | 5.25           | 5/8 - 11   | •                   | •   |

**Material:** Steel: Zinc clear chromate plated, Grade 5 bolt  
SS: 316 stainless steel

### LPH

Locking Plate Heavy

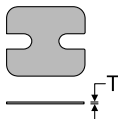

| TUBE FITTING PART # | GROUP # | T THICKNESS (in.) | STANDARD FROM STOCK |
|---------------------|---------|-------------------|---------------------|
| LPH-3               | H3      | 0.31              | •                   |
| LPH-4               | H4      | 0.31              | •                   |
| LPH-5               | H5      | 0.31              | •                   |
| LPH-6               | H6      | 0.39              | •                   |
| LPH-7               | H7      | 0.39              | •                   |

**Material:** Steel, zinc phosphate plated

### SBH

Stacking Bolt Heavy  
(2 required per clamp set)

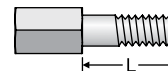

| TUBE FITTING PART # | GROUP # | L LENGTH (in.) | STANDARD FROM STOCK |
|---------------------|---------|----------------|---------------------|
| SBH-3               | H3      | 1.02           | •                   |
| SBH-4               | H4      | 1.61           | •                   |
| SBH-5               | H5      | 2.01           | •                   |
| SBH-6               | H6      | 3.27           | •                   |
| SBH-7               | H7      | 4.33           | •                   |

**Material:** 1010 steel, zinc nickel plated

### WPH

Weld Plate Heavy

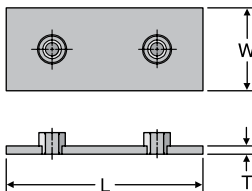

| TUBE FITTING PART # | GROUP # | L LENGTH |      | W WIDTH |      | T THICKNESS |      | STANDARD FROM STOCK |     |
|---------------------|---------|----------|------|---------|------|-------------|------|---------------------|-----|
|                     |         | (in.)    | (mm) | (in.)   | (mm) | (in.)       | (mm) | -S                  | -SS |
| WPH-3               | H3      | 2.88     | 73   | 1.18    | 30   | 0.31        | 8    | •                   | •   |
| WPH-4               | H4      | 3.34     | 85   | 1.18    | 30   | 0.31        | 8    | •                   | •   |
| WPH-5               | H5      | 3.94     | 100  | 1.18    | 30   | 0.31        | 8    | •                   | •   |
| WPH-6               | H6      | 5.51     | 140  | 1.79    | 45   | 0.39        | 10   | •                   | •   |
| WPH-7               | H7      | 7.09     | 180  | 2.36    | 60   | 0.39        | 10   | •                   | •   |

**Material:** Steel: 1020 steel, zinc-phosphate plated  
SS: 316 stainless steel

Dimensions and pressures for reference only, subject to change.

## RH

Mounting Rail Heavy

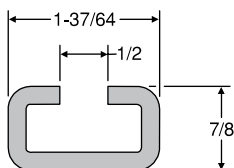

| TUBE FITTING PART # | LENGTH              | STANDARD FROM STOCK |     |
|---------------------|---------------------|---------------------|-----|
|                     |                     | -S                  | -SS |
| R1H                 | 3.28 ft. (1 meter)  | •                   | •   |
| R2H                 | 6.56 ft. (2 meters) | •                   | •   |

**Material:** Steel: Unplated  
SS: 316 stainless steel

## RNH

Mounting Rail Nut Heavy

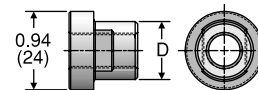

| TUBE FITTING PART # | GROUP #    | D DIAMETER |      | THREAD        | STANDARD FROM STOCK |     |
|---------------------|------------|------------|------|---------------|---------------------|-----|
|                     |            | (in.)      | (mm) |               | -S                  | -SS |
| RNH-10              | H3, H4, H5 | 0.70       | 18   | 3/8 - 16 UNC  | •                   | •   |
| RNH-12              | H6         | 0.78       | 20   | 7/16 - 14 UNC | •                   | •   |

**Material:** Steel: Zinc-phosphate plated  
SS: 316 stainless steel

Note: To be used with mounting rail heavy (RH)

## CRA

Channel Rail Adapter

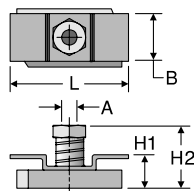

| TUBE FITTING PART # | THREAD "A" UNC | L in. (mm) | B in. (mm) | H1 in. (mm) | H2 in. (mm) | STANDARD FROM STOCK |
|---------------------|----------------|------------|------------|-------------|-------------|---------------------|
| CRA 3-5             | 3/8-16         | 1.37 (35)  | 0.86 (22)  | 0.73 (18.5) | 1.08 (27.5) | •                   |
| CRA 6               | 7/16-14        | 1.77 (45)  | 0.98 (25)  | 0.67 (17)   | 1.08 (27.5) | •                   |

**Material:** Steel, zinc plated, blue chromate

Dimensions and pressures for reference only, subject to change.

# Clamp Halves

Twin Series

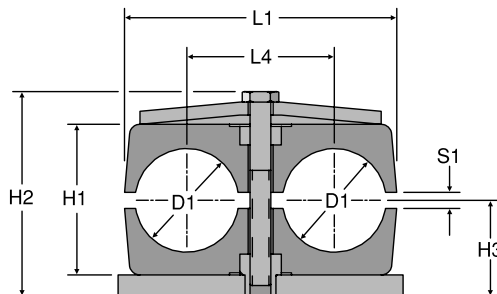

See note below

| TUBE CLAMP HALVES |           |         |      |      |      |      |      |      |      |      |                     |
|-------------------|-----------|---------|------|------|------|------|------|------|------|------|---------------------|
| PART #            | TUBE SIZE | GROUP # | D1   |      | H1   | H2   | H3   | L1   | L4   | S1   | STANDARD FROM STOCK |
|                   |           |         | in.  | mm   | in.  | in.  | in.  | in.  | in.  | in.  |                     |
| 1064/64-PP        | 1/4       | T1      | 0.25 | 6.4  | 0.79 | 1.18 | 0.59 | 1.41 | 0.78 | 0.02 | •                   |
| 1095/95-PP        | 3/8       | T1      | 0.38 | 9.5  | 0.79 | 1.18 | 0.59 | 1.41 | 0.78 | 0.02 | •                   |
| 2127/127-PP       | 1/2       | T2      | 0.50 | 12.7 | 1.06 | 1.73 | 0.71 | 2.08 | 1.14 | 0.03 | •                   |
| 2160/160-PP       | 5/8       | T2      | 0.63 | 16.0 | 1.06 | 1.73 | 0.71 | 2.08 | 1.14 | 0.03 | •                   |
| 3190/190-PP       | 3/4       | T3      | 0.75 | 19.0 | 1.45 | 2.17 | 0.93 | 2.63 | 1.41 | 0.03 | •                   |
| 3254/254-PP       | 1         | T3      | 1.00 | 25.4 | 1.45 | 2.17 | 0.93 | 2.63 | 1.41 | 0.03 | •                   |
| 5320/320-PP       | 1 1/4     | T5      | 1.25 | 32.0 | 2.09 | 2.83 | 1.26 | 4.17 | 2.20 | 0.03 | •                   |
| 5381/381-PP       | 1 1/2     | T5      | 1.50 | 38.1 | 2.09 | 2.83 | 1.26 | 4.17 | 2.20 | 0.03 | •                   |

| PIPE CLAMP HALVES |           |         |      |      |      |      |      |      |      |      |                     |
|-------------------|-----------|---------|------|------|------|------|------|------|------|------|---------------------|
| PART #            | PIPE SIZE | GROUP # | D1   |      | H1   | H2   | H3   | L1   | L4   | S1   | STANDARD FROM STOCK |
|                   |           |         | in.  | mm   | in.  | in.  | in.  | in.  | in.  | in.  |                     |
| 4266/266-PP       | 3/4       | T4      | 1.05 | 26.6 | 1.77 | 2.36 | 1.02 | 3.14 | 1.77 | 0.03 | •                   |
| 5334/334-PP       | 1         | T5      | 1.31 | 33.4 | 2.08 | 2.83 | 1.26 | 4.17 | 2.20 | 0.03 | •                   |

| FOR USE WITH 100R1 HOSE |           |         |      |      |      |      |      |      |      |      |                     |
|-------------------------|-----------|---------|------|------|------|------|------|------|------|------|---------------------|
| PART #                  | HOSE SIZE | GROUP # | D1   |      | H1   | H2   | H3   | L1   | L2   | S1   | STANDARD FROM STOCK |
|                         |           |         | in.  | mm   | in.  | in.  | in.  | in.  | in.  | in.  |                     |
| H3206/206-PP            | 1/2       | T3      | 0.81 | 20.6 | 1.45 | 2.17 | 0.93 | 2.63 | 1.41 | 0.03 | •                   |
| H5205/205-PP            | 1/2       | T5      | 0.81 | 20.5 | 2.09 | 2.83 | 1.26 | 4.17 | 2.20 | 0.03 | •                   |
| H5230/230-PP            | 5/8       | T5      | 0.91 | 23.0 | 2.09 | 2.83 | 1.26 | 4.17 | 2.20 | 0.03 | •                   |
| H5280/280-PP            | 3/4       | T5      | 1.10 | 28.0 | 2.09 | 2.83 | 1.26 | 4.17 | 2.20 | 0.03 | •                   |

| FOR USE WITH 100R2 HOSE |           |         |      |      |      |      |      |      |      |      |                     |
|-------------------------|-----------|---------|------|------|------|------|------|------|------|------|---------------------|
| PART #                  | HOSE SIZE | GROUP # | D1   |      | H1   | H2   | H3   | L1   | L2   | S1   | STANDARD FROM STOCK |
|                         |           |         | in.  | mm   | in.  | in.  | in.  | in.  | in.  | in.  |                     |
| H3190/190-PP            | 3/8       | T3      | 0.75 | 19.0 | 1.45 | 2.17 | 0.93 | 2.63 | 1.41 | 0.03 | •                   |
| H3222/222-PP            | 1/2       | T3      | 0.87 | 22.2 | 1.45 | 2.17 | 0.93 | 2.63 | 1.41 | 0.03 | •                   |
| H3250/250-PP            | 5/8       | T3      | 0.98 | 25.0 | 1.45 | 2.17 | 0.93 | 2.63 | 1.41 | 0.03 | •                   |
| H5295/295-PP            | 3/4       | T5      | 1.16 | 29.5 | 2.09 | 2.83 | 1.26 | 4.17 | 2.20 | 0.03 | •                   |
| H5372/372-PP            | 1         | T5      | 1.46 | 37.2 | 2.09 | 2.83 | 1.26 | 4.17 | 2.20 | 0.03 | •                   |

**Note:** One clamp set includes two identical halves of polypropylene. Tube and pipe clamp halves are black in color. Hose clamp halves are green. Hardware shown in the illustration above is **not** included.

Dimensions and pressures for reference only, subject to change.



### CPT

Cover Plate

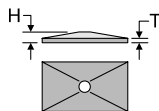

| TUBE FITTING PART # | GROUP # | T THICKNESS |      | H HEIGHT |      | STANDARD FROM STOCK |     |
|---------------------|---------|-------------|------|----------|------|---------------------|-----|
|                     |         | (in.)       | (mm) | (in.)    | (mm) | -S                  | -SS |
| CPT-1               | T1      | 0.06        | 1.5  | —        | —    | •                   | •   |
| CPT-2               | T2      | 0.13        | 3.0  | 0.28     | 7.0  | •                   | •   |
| CPT-3               | T3      | 0.13        | 3.0  | 0.28     | 7.0  | •                   | •   |
| CPT-4               | T4      | 0.13        | 3.0  | 0.31     | 8.0  | •                   | •   |
| CPT-5               | T5      | 0.13        | 3.0  | 0.31     | 8.0  | •                   | •   |

**Material:** Steel: Zinc nickel plated  
SS: 316 stainless steel

### BCPT

Hexagon Head Bolt for Cover Plate

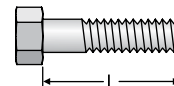

| TUBE FITTING PART # | GROUP # | L LENGTH (in.) | UNC THREAD | STANDARD FROM STOCK |     |
|---------------------|---------|----------------|------------|---------------------|-----|
|                     |         |                |            | -S                  | -SS |
| BCPT-1              | T1      | 1.38           | 1/4 - 20   | •                   | •   |
| BCPT-2              | T2      | 1.38           | 5/16 - 18  | •                   | •   |
| BCPT-3              | T3      | 1.75           | 5/16 - 18  | •                   | •   |
| BCPT-4              | T4      | 2.00           | 5/16 - 18  | •                   | •   |
| BCPT-5              | T5      | 2.50           | 5/16 - 18  | •                   | •   |

**Material:** Steel: Zinc clear chromate plated, Grade 10 material  
SS: 316 stainless steel

### LPT

Locking Plate

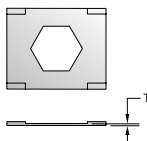

| TUBE FITTING PART # | GROUP # | T THICKNESS (in.) | STANDARD FROM STOCK |
|---------------------|---------|-------------------|---------------------|
| LPT-1               | T1      | 0.02              | •                   |
| LPT-2               | T2      | 0.02              | •                   |
| LPT-3               | T3      | 0.02              | •                   |
| LPT-4               | T4      | 0.02              | •                   |
| LPT-5               | T5      | 0.02              | •                   |

**Material:** Steel, zinc nickel plated

### SBT

Stacking Bolt

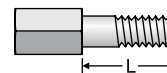

| TUBE FITTING PART # | GROUP # | L LENGTH (in.) | UNC THREAD | STANDARD FROM STOCK |
|---------------------|---------|----------------|------------|---------------------|
| SBT-1               | T1      | 0.59           | 1/4 - 20   | •                   |
| SBT-2               | T2      | 0.78           | 5/16 - 18  | •                   |
| SBT-3               | T3      | 1.13           | 5/16 - 18  | •                   |
| SBT-4               | T4      | 1.69           | 5/16 - 18  | •                   |
| SBT-5               | T5      | 1.78           | 5/16 - 18  | •                   |

**Material:** Zinc nickel plated, 1010 steel

Dimensions and pressures for reference only, subject to change.

**WPT**  
Weld Plate Twin

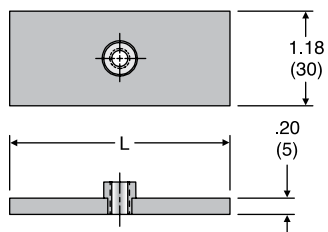

| TUBE FITTING PART # | GROUP # | L LENGTH |      | STANDARD FROM STOCK |     |
|---------------------|---------|----------|------|---------------------|-----|
|                     |         | (in.)    | (mm) | -S                  | -SS |
| WPT-1               | T1      | 1.47     | 37   | •                   | •   |
| WPT-2               | T2      | 2.31     | 55   | •                   | •   |
| WPT-3               | T3      | 2.75     | 70   | •                   | •   |
| WPT-4               | T4      | 3.34     | 85   | •                   | •   |
| WPT-5               | T5      | 4.34     | 110  | •                   | •   |

Material: Steel: Zinc-phosphate plated  
SS: 316 stainless steel

**R**  
Mounting Rail

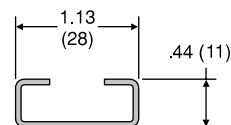

| TUBE FITTING PART # | LENGTH              | STANDARD FROM STOCK |     |
|---------------------|---------------------|---------------------|-----|
|                     |                     | -S                  | -SS |
| R-1                 | 3.28 ft. (1 meter)  | •                   | •   |
| R-2                 | 6.56 ft. (2 meters) | •                   | •   |

Material: Steel: Unplated  
SS: 316 stainless steel

**RNT**  
Mounting Rail Nut Twin

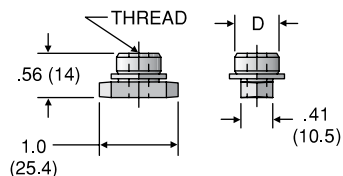

| TUBE FITTING PART # | GROUP # | D DIAMETER |      | THREAD        | STANDARD FROM STOCK |     |
|---------------------|---------|------------|------|---------------|---------------------|-----|
|                     |         | (in.)      | (mm) |               | -S                  | -SS |
| RNT-1               | T1      | 0.39       | 10   | 1/4 - 20 UNC  | •                   | •   |
| RNT-2-5             | T2-T5   | 0.56       | 14   | 5/16 - 18 UNC | •                   | •   |

Material: Steel: Zinc nickel plated  
SS: 316 stainless steel

Note: to be used with mounting rail (R)

**CRA**  
Channel Rail Adapter

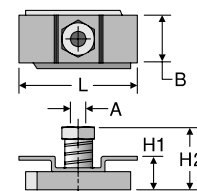

| TUBE FITTING PART # | THREAD "A" UNC | L in. (mm) | B in. (mm) | H1 in. (mm) | H2 in. (mm) | STANDARD FROM STOCK |
|---------------------|----------------|------------|------------|-------------|-------------|---------------------|
| CRA 2-3D            | 5/16-18        | 1.49 (38)  | 2.55 (65)  | 0.73 (18.5) | 1.08 (27.5) | •                   |

Material: Steel, zinc plated, blue chromate

Dimensions and pressures for reference only, subject to change.

### 3121-1

Tube Clip

| PART #<br>BRASS | END SIZE<br>(in.) | G<br>(in.) | H<br>(in.) | J<br>(in.) | O<br>(in.) | HOLE DIA.<br>(in.) | STANDARD FROM STOCK |
|-----------------|-------------------|------------|------------|------------|------------|--------------------|---------------------|
| 3121-1-3        | 3/16              | 5/16       | 9/32       | 17/32      | 1/32       | 5/32               | •                   |
| 3121-1-4        | 1/4               | 3/8        | 11/32      | 21/32      | 1/32       | 3/16               | •                   |
| 3121-1-5        | 5/16              | 7/16       | 13/32      | 13/16      | 1/32       | 3/16               | •                   |
| 3121-1-6        | 3/8               | 1/2        | 15/32      | 15/16      | 1/32       | 3/16               | •                   |
| 3121-1-8        | 1/2               | 1/2        | 35/64      | 1 1/16     | 3/64       | 7/32               | •                   |
| 3121-1-10       | 5/8               | 5/8        | 11/16      | 1 5/16     | 1/16       | 1/4                | •                   |
| 3121-1-12       | 3/4               | 3/4        | 13/16      | 1 9/16     | 1/16       | 9/32               | •                   |

Material: Brass

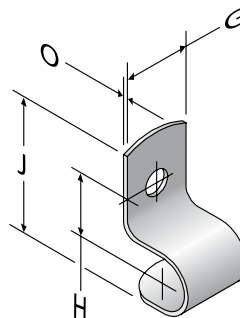

### 3121-3

Tube Clip

| PART #<br>BRASS | END SIZE<br>(in.) | G<br>(in.) | H<br>(in.) | M<br>(in.) | O<br>(in.) | HOLE DIA.<br>(in.) | STANDARD FROM STOCK |
|-----------------|-------------------|------------|------------|------------|------------|--------------------|---------------------|
| 3121-3-3        | 3/16              | 5/16       | 9/32       | 7/8        | 1/32       | 5/32               | •                   |
| 3121-3-4        | 1/4               | 3/8        | 11/32      | 1 1/16     | 1/32       | 3/16               | •                   |
| 3121-3-5        | 5/16              | 7/16       | 13/32      | 1 1/4      | 1/32       | 3/16               | •                   |
| 3121-3-6        | 3/8               | 1/2        | 15/32      | 1 7/16     | 1/32       | 3/16               | •                   |
| 3121-3-8        | 1/2               | 1/2        | 35/64      | 1 19/32    | 3/64       | 7/32               | •                   |
| 3121-3-10       | 5/8               | 5/8        | 11/16      | 2          | 1/16       | 1/4                | •                   |
| 3121-3-12       | 3/4               | 3/4        | 13/16      | 2 3/8      | 1/16       | 9/32               | •                   |

Material: Brass

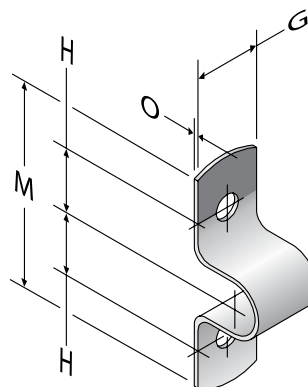

### 3121-4

Tube Clip

| PART #<br>BRASS | END SIZE<br>(in.) | G<br>(in.) | H<br>(in.) | N<br>(in.) | O<br>(in.) | HOLE DIA.<br>(in.) | STANDARD FROM STOCK |
|-----------------|-------------------|------------|------------|------------|------------|--------------------|---------------------|
| 3121-4-3        | 3/16              | 5/16       | 9/32       | 13/16      | 1/32       | 5/32               | •                   |
| 3121-4-4        | 1/4               | 3/8        | 11/32      | 1          | 1/32       | 3/16               | •                   |
| 3121-4-5        | 5/16              | 7/16       | 13/32      | 1 3/16     | 1/32       | 3/16               | •                   |
| 3121-4-6        | 3/8               | 1/2        | 15/32      | 1 3/8      | 1/32       | 3/16               | •                   |
| 3121-4-8        | 1/2               | 1/2        | 35/64      | 1 11/16    | 3/64       | 7/32               | •                   |
| 3121-4-10       | 5/8               | 5/8        | 11/16      | 2 1/8      | 1/16       | 1/4                | •                   |
| 3121-4-12       | 3/4               | 3/4        | 13/16      | 2 1/2      | 1/16       | 9/32               | •                   |

Material: Brass

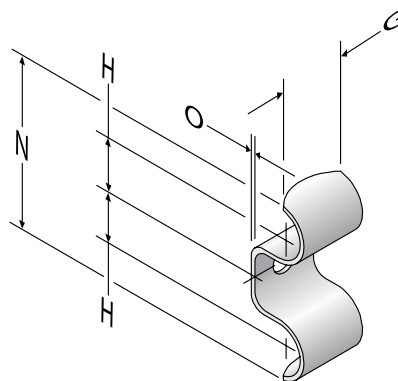

Dimensions and pressures for reference only, subject to change.

