

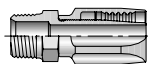









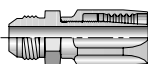
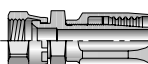
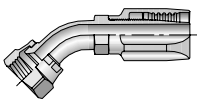
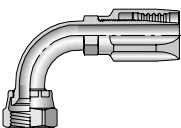
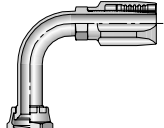

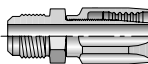
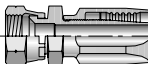
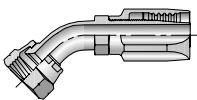
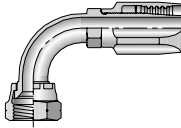
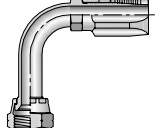

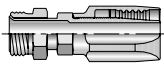
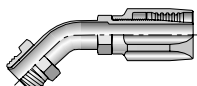
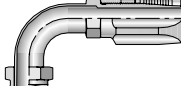

	20120 B-150  Male - Rigid		20320 B-150  Male - Rigid	20620 B-151  Female - Swivel	23720 B-151  Female - Swivel 45° Elbow - Short
23920 B-152  Female - Swivel 90° Elbow - Short	24120 B-152  Female - Swivel 90° Elbow - Long		20420 B-152  Male - Rigid	20820 B-153  Female - Swivel	27720 B-153  Female - Swivel 45° Elbow
27920 B-153  Female - Swivel 90° Elbow	28120 B-154  Female - Swivel 90° Elbow - Long		21120 B-154  Male - Rigid		22820 B-154  Male - Swivel
26720 B-154  Male - Swivel 45° Elbow	26920 B-155  Male - Swivel 90° Elbow		23220 B-155  Female - Swivel		26120 B-155  Male (without Nut or Sleeve)
	21520 B-155  Flange	21720 B-156  45° Elbow	21920 B-156  90° Elbow		2JS20 B-156  Female - Swivel Long
2J720 B-156  Female - Swivel 45° Elbow	2J920 B-157  Female - Swivel 90° Elbow - Short	2J120 B-157  Female - Swivel 90° Elbow - Long		20 Series Assembly Instructions B-158	

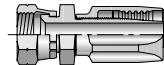
A

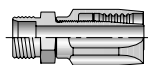
B

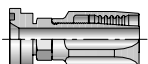
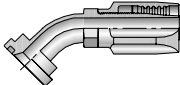
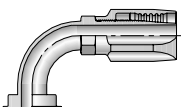
C

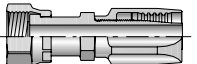
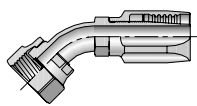
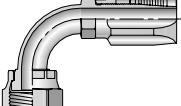
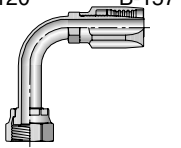
D

E

20120

Male NPTF Pipe - Rigid

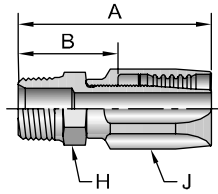

# Part Number	Thread		Hose I.D. inch	A		H inch	J inch	B		Additional Material Brass (B)
	inch			inch	mm			inch	mm	
20120-2-4	1/8x27		3/16	1.72	44	7/16	5/8	0.94	24	
20120-2-5	1/8x27		1/4	1.82	46	1/2	11/16	0.99	25	
20120-4-4	1/4x18		3/16	1.93	49	9/16	5/8	1.15	29	
20120-4-5	1/4x18		1/4	2.01	51	9/16	11/16	1.18	30	
20120-4-6	1/4x18		5/16	2.11	54	9/16	13/16	1.19	30	
20120-6-6	3/8x18		5/16	2.20	56	3/4	13/16	1.28	33	
20120-6-8	3/8x18		13/32	2.48	63	3/4	15/16	1.39	35	
20120-8-8	1/2x14		13/32	2.73	69	7/8	15/16	1.64	42	
20120-8-10	1/2x14		1/2	2.88	73	7/8	1-1/8	1.66	42	
20120-12-10	3/4x14		1/2	2.95	75	1-1/16	1-1/8	1.73	44	
20120-12-12	3/4x14		5/8	3.25	83	1-1/16	1-1/4	1.75	44	
20120-12-16	3/4x14		7/8	2.81	71	1-3/8	1-7/16	1.62	41	
20120-16-16	1x11-1/2		7/8	2.99	76	1-3/8	1-7/16	1.80	46	•
20120-20-20	1-1/4x11-1/2		1-1/8	3.24	82	1-3/4	1-3/4	1.96	50	•
20120-24-24	1-1/2x11-1/2		1-3/8	3.50	89	2	2	2.13	54	•
20120-32-32	2 x11-1/2		1-13/16	4.05	103	2-1/2	2-1/2	2.31	59	•

20320

Male JIC 37° - Rigid

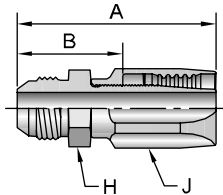

# Part Number	Thread		Hose I.D. inch	A		H inch	J inch	B	
	inch			inch	mm			inch	mm
20320-4-4	1/4	7/16x20	3/16	1.83	46	1/2	5/8	1.05	27
20320-5-5	5/16	1/2x20	1/4	1.94	49	9/16	11/16	1.11	28
20320-6-6	3/8	9/16x18	5/16	2.11	54	5/8	13/16	1.19	30
20320-8-8	1/2	3/4x16	13/32	2.57	65	13/16	15/16	1.48	38
20320-10-10	5/8	7/8x14	1/2	2.88	73	15/16	1-1/8	1.66	42
20320-12-12	3/4	1-1/16x12	5/8	3.35	85	1-1/8	1-1/4	1.85	47
20320-16-16	1	1-5/16x12	7/8	2.95	75	1-3/8	1-7/16	1.76	45

20620

Female JIC 37° - Swivel

# Part Number	Thread		Hose I.D. inch	A		H inch	J inch	W inch	B		Additional Material Stainless Steel (C)
	inch	inch		inch	mm				inch	mm	
20620-4-4	1/4	7/16x20	3/16	1.94	49	9/16	5/8	9/16	1.16	29	•
20620-4-5	1/4	7/16x20	1/4	2.04	52	9/16	11/16	9/16	1.21	31	
20620-5-5	5/16	1/2x20	1/4	2.12	54	5/8	11/16	5/8	1.29	33	
20620-6-5	3/8	9/16x18	1/4	2.19	56	11/16	11/16	11/16	1.36	35	
20620-6-6	3/8	9/16x18	5/16	2.32	59	11/16	13/16	11/16	1.40	36	•
20620-8-6	1/2	3/4x16	5/16	2.44	62	7/8	13/16	7/8	1.52	39	
20620-8-8	1/2	3/4x16	13/32	2.79	71	7/8	15/16	7/8	1.70	43	•
20620-8-10	1/2	3/4x16	1/2	2.99	76	7/8	1-1/8	7/8	1.77	45	
20620-10-8	5/8	7/8x14	13/32	2.94	75	7/8	15/16	1	1.85	47	
20620-10-10	5/8	7/8x14	1/2	3.10	79	1	1-1/8	1	1.88	48	•
20620-10-12	5/8	7/8x14	5/8	3.40	86	1	1-1/4	1	1.90	48	
20620-12-12	3/4	1-1/16x12	5/8	3.49	89	1-1/4	1-1/4	1-1/4	1.99	51	•
20620-16-16	1	1-5/16x12	7/8	3.20	81	1-1/2	1-7/16	1-1/2	2.01	51	•
20620-20-20	1-1/4	1-5/8x12	1-1/8	3.56	90	2	1-3/4	2	2.28	58	
20620-24-24	1-1/2	1-7/8x12	1-3/8	3.95	100	2-1/4	2	2-1/4	2.58	66	
20620-32-32	2	2-1/2x12	1-13/16	4.71	120	2-7/8	2-1/2	2-7/8	2.97	75	

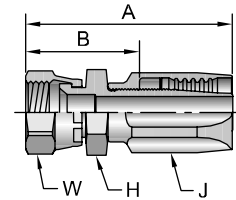

A

B

23720

Female JIC 37° - Swivel - 45° Elbow - Short Drop

# Part Number	Thread		Hose I.D. inch	A		E		H inch	J inch	W inch	B	
	inch	inch		inch	mm	inch	mm				inch	mm
23720-4-4	1/4	7/16x20	3/16	2.08	53	0.33	8	3/8	5/8	9/16	1.30	33
23720-5-5	5/16	1/2x20	1/4	2.30	58	0.36	9	7/16	11/16	5/8	1.47	37
23720-6-6	3/8	9/16x18	5/16	2.45	62	0.39	10	1/2	13/16	11/16	1.53	39
23720-8-6	1/2	3/4x16	5/16	2.77	70	0.55	14	5/8	13/16	7/8	1.85	47
23720-10-10	5/8	7/8x14	1/2	3.36	85	0.65	17	3/4	1-1/8	1	2.14	54
23720-12-12	3/4	1-1/16x12	5/8	3.94	100	0.79	20	7/8	1-1/4	1-1/4	2.44	62
23720-16-16	1	1-5/16x12	7/8	3.73	95	0.90	23	1-1/8	1-7/16	1-1/2	2.54	65
23720-20-20	1-1/4	1-5/8x12	1-1/8	4.17	106	1.19	30	1-1/2	1-3/4	2	2.89	73

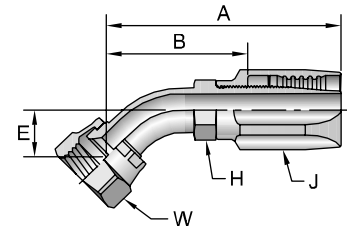

C

D

E

23920

Female JIC 37° - Swivel - 90° Elbow - Short Drop

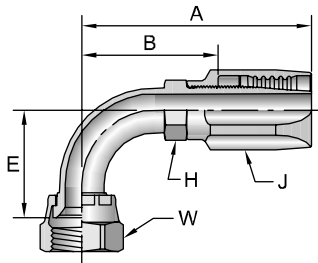

# Part Number	Thread		Hose I.D. inch	A		E		H inch	J inch	W inch	B	
	inch			inch	mm	inch	mm				inch	mm
23920-4-4	1/4	7/16x20	3/16	1.91	49	0.83	21	3/8	5/8	9/16	1.13	29
23920-5-5	5/16	1/2x20	1/4	2.30	58	0.77	20	7/16	11/16	5/8	1.47	37
23920-6-6	3/8	9/16x18	5/16	2.35	60	0.90	23	1/2	13/16	11/16	1.43	36
23920-8-8	1/2	3/4x16	13/32	2.88	73	1.09	28	5/8	15/16	7/8	1.79	45
23920-10-10	5/8	7/8x14	1/2	3.20	81	1.24	31	3/4	1-1/8	1	1.98	50
23920-12-12	3/4	1-1/16x12	5/8	3.86	98	1.82	46	7/8	1-1/4	1-1/4	2.36	60
23920-16-16	1	1-5/16x12	7/8	3.69	94	2.14	54	1-1/8	1-7/16	1-1/2	2.50	64
23920-20-20	1-1/4	1-5/8x12	1-1/8	4.01	102	2.59	66	1-1/2	1-3/4	2	2.73	69
23920-24-24	1-1/2	1-7/8x12	1-3/8	4.43	113	2.82	72	1-3/4	2	2-1/4	3.06	78

24120

Female JIC 37° - Swivel - 90° Elbow - Long Drop

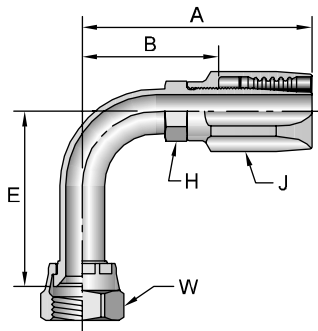

# Part Number	Thread		Hose I.D. inch	A		E		H inch	J inch	W inch	B	
	inch			inch	mm	inch	mm				inch	mm
24120-4-4	1/4	7/16x20	3/16	2.08	53	1.80	46	3/8	5/8	9/16	1.30	33
24120-6-6	3/8	9/16x18	5/16	2.34	59	2.18	55	1/2	13/16	11/16	1.42	36
24120-8-8	1/2	3/4x16	13/32	2.95	75	2.43	62	5/8	15/16	7/8	1.86	47
24120-10-10	5/8	7/8x14	1/2	3.26	83	2.58	66	3/4	1-1/8	1	2.04	52
24120-12-12	3/4	1-1/16x12	5/8	3.78	96	3.74	95	7/8	1-1/4	1-1/4	2.28	58

20420

Male SAE 45° - Rigid

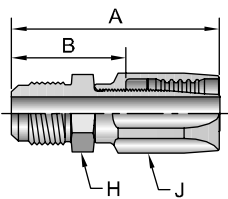

# Part Number	Thread		Hose I.D. inch	A		H inch	J inch	B	
	inch			inch	mm			inch	mm
20420-4-4	1/4	7/16x20	3/16	1.80	46	1/2	5/8	1.02	26
20420-5-5	5/16	1/2x20	1/4	1.94	49	9/16	11/16	1.11	28
20420-6-6	3/8	5/8x18	5/16	2.17	55	11/16	13/16	1.25	32
20420-8-8	1/2	3/4x16	13/32	2.67	68	13/16	15/16	1.58	40
20420-10-10	5/8	7/8x14	1/2	3.00	76	15/16	1-1/8	1.78	45
20420-12-12	3/4	1-1/16x14	5/8	3.50	89	1-1/8	1-1/4	2.00	51

20820

Female SAE 45° - Swivel

# Part Number	Thread		Hose I.D. inch	A		H inch	J inch	W inch	B	
	inch			inch	mm				inch	mm
20820-4-4	1/4	7/16x20	3/16	1.94	49	9/16	5/8	9/16	1.16	29
20820-4-5	1/4	7/16x20	1/4	2.04	52	9/16	11-16	9/16	1.21	31
20820-5-5	5/16	1/2x20	1/4	2.12	54	5/8	11-16	5/8	1.29	33
20820-6-6	3/8	5/8x18	5/16	2.36	60	3/4	13/16	3/4	1.44	37
20820-8-8	1/2	3/4x16	3/8	2.79	71	7/8	15/16	7/8	1.70	43
20820-8-10	1/2	3/4x16	1/2	2.99	76	7/8	1-1/8	7/8	1.77	45
20820-10-10	5/8	7/8x14	1/2	3.10	79	1	1-1/8	1	1.88	48
20820-12-12	3/4	1-1/16x14	5/8	3.49	89	1-1/4	1-1/4	1-1/4	1.99	51

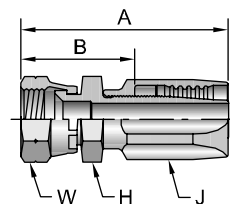

27720

Female SAE 45° - Swivel - 45° Elbow

# Part Number	Thread		Hose I.D. inch	A		E		H inch	J inch	W inch	B	
	inch			inch	mm	inch	mm				inch	mm
27720-6-6	3/8	5/8x18	5/16	2.45	62	0.39	10	1/2	13/16	3/4	1.53	39
27720-8-6	1/2	3/4x16	5/16	2.77	71	0.55	14	5/8	13/16	7/8	1.86	47
27720-8-8	1/2	3/4x16	13/32	3.09	78	0.55	14	5/8	15/16	7/8	2.00	51
27720-10-10	5/8	7/8x14	1/2	3.35	85	0.65	17	3/4	1-1/8	1	2.13	54

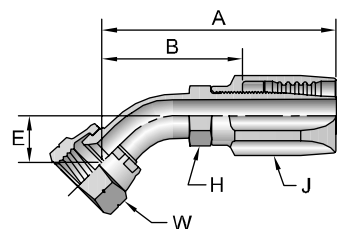

27920

Female SAE 45° - Swivel - 90° Elbow

# Part Number	Thread		Hose I.D. inch	A		E		H inch	J inch	W inch	B	
	inch			inch	mm	inch	mm				inch	mm
27920-4-4	1/4	7/16x20	3/16	1.91	49	0.83	21	3/8	5/8	9/16	1.13	29
27920-5-5	5/16	1/2x20	1/4	2.30	58	0.77	20	7/16	11/16	5/8	1.47	37
27920-6-6	3/8	5/8x18	5/16	2.33	59	0.85	22	1/2	13/16	3/4	1.41	36
27920-8-8	1/2	3/4x16	13/32	2.86	73	1.09	28	5/8	15/16	7/8	1.77	45
27920-10-10	5/8	7/8x14	1/2	3.20	81	1.24	31	3/4	1-1/8	1	1.98	50
27920-12-12	3/4	1-1/16x14	5/8	3.87	98	1.82	46	7/8	1-1/4	1-1/4	2.37	60

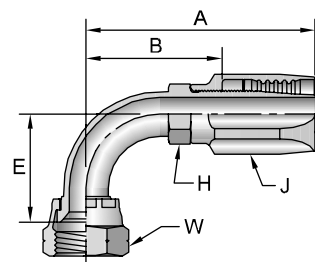

Notch in nut signifies 45° flare.

28120

Female SAE 45° - Swivel - 90° Elbow - Long Drop

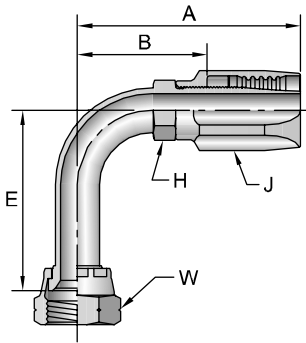

#	Thread		Hose I.D.		A		E		H	J	W	B	
Part Number	inch		inch	mm	inch	mm	inch	mm	inch	inch	inch	inch	mm
28120-6-6	3/8	5/8x18	5/16	2.34	59	2.18	55	1/2	13/16	3/4	1.42	36	
28120-8-8	1/2	3/4x16	13/32	2.95	75	2.43	62	5/8	15/16	7/8	1.86	47	

Notch in nut signifies 45° flare.

21120

Male Ferulok Flareless - Rigid (24° Cone with Nut and Ferrule)

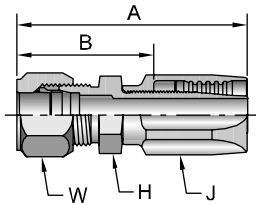

#	Thread		Hose I.D.		A		H	J	W	B	
Part Number	inch		inch	mm	inch	mm	inch	inch	inch	inch	mm
21120-6-6	3/8	9/16x18	5/16	2.05	52	5/8	13/16	11/16	1.13	29	
21120-8-8	1/2	3/4x16	13/32	2.52	64	13/16	15/16	7/8	1.43	36	

The Parker Ferrule-Fix fitting makes it possible to salvage the bent tube section from a hose assembly for quick, easy on the job repairs. For additional information see Ferrule-Fix installation instructions in the Technical Section.

22820

Male Inverted SAE 45° - Swivel

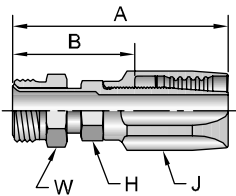

#	Thread		Hose I.D.		A		H	J	W	B	
Part Number	inch		inch	mm	inch	mm	inch	inch	inch	inch	mm
22820-4-4	1/4	7/16x24	3/16	2.45	62	3/8	5/8	7/16	1.67	42	
22820-5-5	5/16	1/2x20	1/4	2.70	69	7/16	11/16	1/2	1.87	47	
22820-6-6	3/8	5/8x18	5/16	2.95	75	1/2	13/16	5/8	2.03	52	
22820-8-8	1/2	3/4x18	13/32	3.36	85	5/8	15/16	3/4	2.27	58	
22820-10-10	5/8	7/8x18	1/2	3.64	92	3/4	1-1/8	7/8	2.42	61	

26720

Male Inverted SAE 45° - Swivel - 45° Elbow

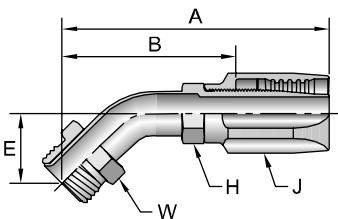

#	Thread		Hose I.D.		A		E		H	J	W	B	
Part Number	inch		inch	mm	inch	mm	inch	mm	inch	inch	inch	inch	mm
26720-4-4	1/4	7/16x24	3/16	2.21	56	0.62	16	3/8	5/8	7/16	1.43	36	
26720-5-5	5/16	1/2x20	1/4	2.44	62	0.70	18	7/16	11/16	1/2	1.61	41	
26720-6-6	3/8	5/8x18	5/16	3.00	76	0.94	24	1/2	13/16	5/8	2.08	53	
26720-8-8	1/2	3/4x18	13/32	3.51	89	1.09	28	5/8	15/16	3/4	2.42	61	

26920

Male Inverted SAE 45° - Swivel - 90° Elbow

# Part Number	Thread		Hose I.D. inch	A		E		H inch	J inch	W inch	B	
	inch	mm		inch	mm	inch	mm				inch	mm
26920-4-4	1/4	7/16x24	3/16	2.29	58	1.56	40	3/8	5/8	7/16	1.51	38
26920-5-5	5/16	1/2x20	1/4	2.55	65	1.65	42	7/16	11/16	1/2	1.72	44
26920-5-6	5/16	1/2x20	5/16	2.63	67	1.65	42	1/2	13/16	1/2	1.71	43
26920-6-6	3/8	5/8x18	5/16	2.67	68	1.69	43	1/2	13/16	5/8	1.75	44
26920-8-8	1/2	3/4x18	13/32	3.09	78	1.88	48	5/8	15/16	3/4	2.00	51

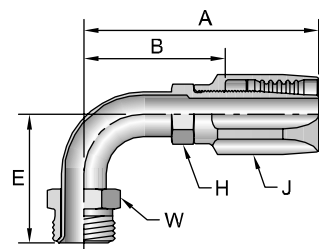

23220

Female PTT 30° - Swivel

# Part Number	Thread		Hose I.D. inch	A		H inch	J inch	W inch	B	
	inch	mm		inch	mm				inch	mm
23220-16-16	1	1-5/16x14	7/8	2.98	76	1-1/2	1-7/16	1-1/2	1.79	45

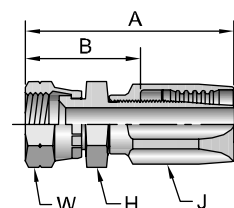

26120

Male SAE Compression Seat (without Nut or Sleeve)

# Part Number	Thread		Hose I.D. inch	A		H inch	J inch	B	
	inch	mm		inch	mm			inch	mm
26120-10-10	5/8	13/16x18	1/2	2.64	67	7/8	1-1/8	1.42	36

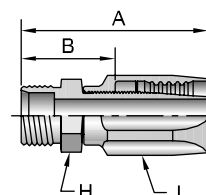

21520

SAE Code 61 Flange Head ISO 12151-3-S-L

# Part Number	Flange inch	Hose I.D. inch	A		F inch	H inch	J inch	B	
			inch	mm				inch	mm
21520-20-20	1-1/4	1-1/8	3.58	91	2	1-1/2	1-3/4	2.30	58
21520-40-40	2-1/2	2-3/8	5.22	133	3-5/16	2-3/4	3-1/8	3.41	87

See Accessories Section for O-Rings and Flange Kits.

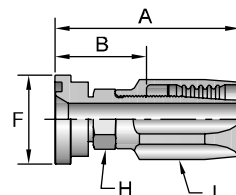

21720

SAE Code 61 Flange Head - 45° Elbow

ISO 12151-3- E45S - L (1 Piece: ISO 12151-3- E45M - L)

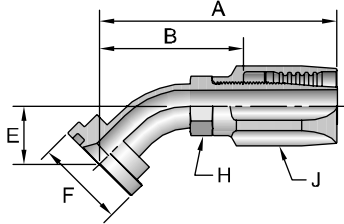

#			A		E					B	
Part Number	Flange inch	Hose I.D. inch	inch	mm	inch	mm	inch	inch	inch	inch	mm
21720-20-20	1-1/4	1-1/8	4.10	104	1.12	28	2	1-1/2	1-3/4	2.82	72
21720-40-40	2-1/2	2-3/8	5.83	148	1.41	36	3-3/8	2-3/4	3-1/8	4.02	102

21920

SAE Code 61 Flange Head - 90° Elbow

ISO 12151-3- E90S - L (1 Piece: ISO 12151-3- E90M - L)

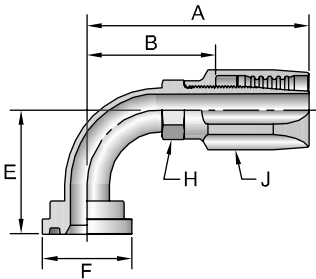

#			A		E					B	
Part Number	Flange inch	Hose I.D. inch	inch	mm	inch	mm	inch	inch	inch	inch	mm
21920-8-8	1/2	13/32	2.95	75	1.62	41	1-3/16	5/8	15/16	1.86	47
21920-32-32	2	1-13/16	5.44	138	3.19	81	2-13/16	2-1/4	2-1/2	3.70	94
21920-40-40	2-1/2	2-3/8	6.18	157	3.75	95	3-5/16	2-3/4	3-1/8	4.37	111

2JS20

Female Seal-Lok® - Swivel - Long

ISO 12151-1 - SWSB

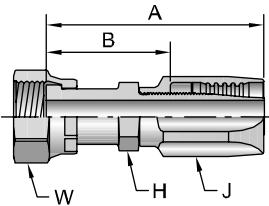

#			A					B		
Part Number	Thread inch	Hose I.D. inch	inch	mm	inch	inch	inch	inch	mm	
2JS20-4-4	1/4	9/16x18	3/16	2.07	53	9/16	5/8	11/16	1.29	33
2JS20-6-6	3/8	11/16x16	5/16	2.36	60	1/2	13/16	13/16	1.44	37
2JS20-8-8	1/2	13/16x16	13/32	2.92	74	5/8	15/16	15/16	1.83	46
2JS20-10-10	5/8	1x14	1/2	3.15	80	3/4	1-1/8	1-1/8	1.93	49
2JS20-12-12	3/4	1-3/16x12	5/8	3.66	93	1-1/8	1-1/4	1-3/8	2.16	55

2J720

Female Seal-Lok® - Swivel - 45° Elbow

ISO 12151-1 - SWE45

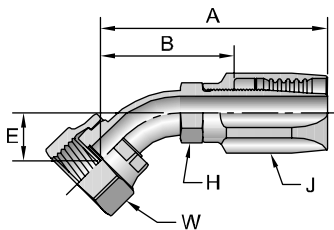

#			A		E					B		
Part Number	Thread inch	Hose I.D. inch	inch	mm	inch	mm	inch	inch	inch	inch	mm	
2J720-4-4	1/4	9/16x18	3/16	2.24	57	0.41	10	7/16	5/8	11/16	1.46	37
2J720-6-6	3/8	11/16x16	5/16	2.52	64	0.43	11	1/2	13/16	13/16	1.60	41
2J720-8-8	1/2	13/16x16	13/32	3.19	81	0.59	15	5/8	15/16	15/16	2.10	53
2J720-10-10	5/8	1x14	1/2	3.46	88	0.65	17	3/4	1-1/8	1-1/8	2.24	57

See Accessories Section for O-Rings and Flange Kits.

2J920

Female Seal-Lok® - Swivel 90° Elbow - Short Drop

ISO 12151-1 - SWE90

# Part Number	Thread		Hose I.D. inch	A		E		H inch	J inch	W inch	B	
	inch	inch		inch	mm	inch	mm				inch	mm
2J920-4-4	1/4	9/16x18	3/16	2.22	56	0.82	21	7/16	5/8	11/16	1.44	37
2J920-6-6	3/8	11/16x16	5/16	2.39	61	0.90	23	1/2	13/16	13/16	1.47	37
2J920-8-8	1/2	13/16x16	13/32	2.91	74	1.15	29	5/8	15/16	15/16	1.82	46
2J920-10-10	5/8	1x14	1/2	3.16	80	1.27	32	3/4	1-1/8	1-1/8	1.94	49
2J920-12-12	3/4	1-3/16x12	5/8	3.74	95	1.85	47	7/8	1-1/4	1-3/8	2.24	57

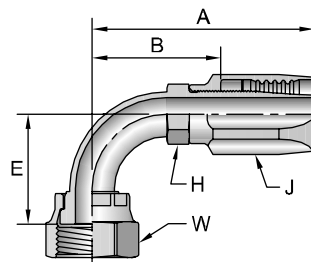

2J120

Female Seal-Lok® - Swivel - 90° Elbow - Long Drop

ISO 12151-1 - SWEL90

# Part Number	Thread		Hose I.D. inch	A		E		H inch	J inch	W inch	B	
	inch	inch		inch	mm	inch	mm				inch	mm
2J120-4-4	1/4	9/16x18	3/16	2.01	51	1.80	46	7/16	5/8	11/16	1.23	31
2J120-6-6	3/8	11/16x16	5/16	2.48	63	2.13	54	1/2	13/16	13/16	1.56	40
2J120-8-8	1/2	13/16x16	13/32	2.96	75	2.51	64	5/8	15/16	15/16	1.87	47

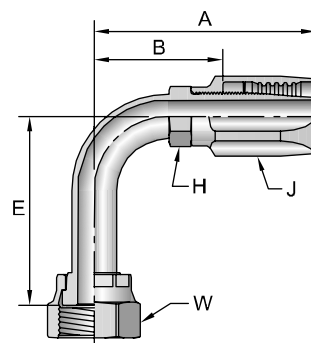

See Accessories Section for O-Rings.

20 Series Hose Assembly Instructions

A

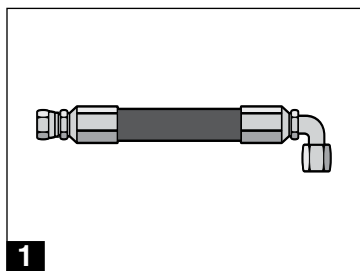

1. Identify over all length (OAL) of hose assembly and the cut off allowance (COA) length of fitting(s) on hose ends by use of the fitting data table. Properly measure, mark and cut hose to desired length using fine tooth hacksaw or cutoff machine. Care should be taken to ensure a square, clean cut is obtained.

B

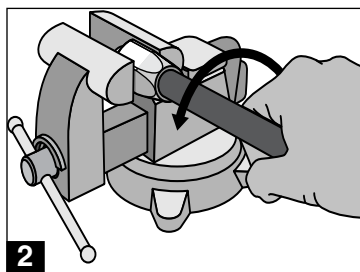

2. Air or solvent flush cut end of hose as necessary to produce a clean hose ID prior to assembly. Place socket in vice and screw in hose counter clockwise until hose bottoms. Back hose out 1/2 turn.

C

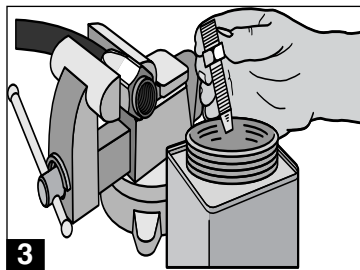

3. Oil inside of hose and nipple threads liberally with Hoze-Oil. (See Section C). Do not oil hose cover.

D

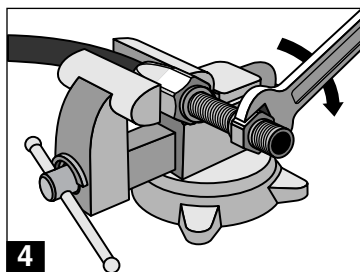

4. Screw nipple assembly into socket using a wrench on the nipple hex until the nipple hex shoulders against the socket. A 1/32" to 1/16" gap between the nipple hex and socket is allowed for displacement angle adjustment when two elbow fittings are used.

Inspection. Examine hose assembly internally for cut or bulged tube, obstructions and cleanliness. Clean ID of hose as necessary. Swivel nuts should turn freely. Check the layline of the hose to be sure the assembly is not twisted. Cap the ends of the assembly to keep clean.

Special Instructions for stainless steel fittings. When assembling fittings made with 316 stainless steel, lubricate the threads of both the socket and nipple with Accrolube High Efficiency Lubricant (see Section C) or equivalent metal assembly lubricant.

Note: DISASSEMBLE IN REVERSE ORDER

IF YOU HAVE QUESTIONS CONCERNING THE PRODUCTS OR APPLICATION OF THE PRODUCTS CONTAINED IN THIS CATALOG, PLEASE CALL: PARKER HOSE PRODUCTS DIVISION - TECHNICAL SERVICES DEPARTMENT

PHONE: 440/943-5700

FAX: 440/943-3129

<http://www.parkerhose.com>