

EXACT12, 8XM12, 5-POLE, MOULDED CABLE

10.0m PUR/PVC 16x0,34+3X0.75, UL/CSA

8-way, 5-pole

Further cable lengths on request.

Plastic housings with good resistance against chemicals and oils.

The resistance to aggressive media should be individually tested for your application. Further details on request.

PUR/PVC

10.0 m

[Link to Product](#)**Illustration**

M12-Females 5-pole

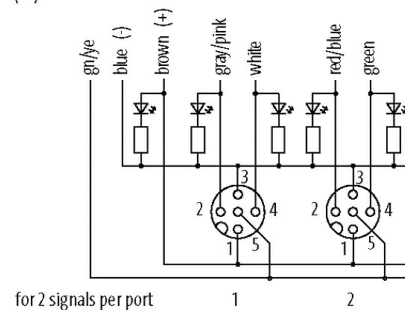
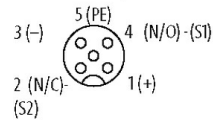

for 2 signals per port

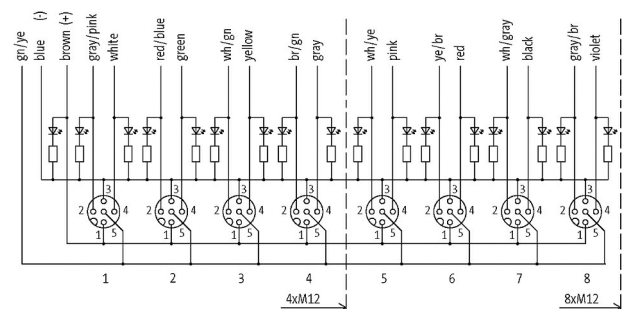

Product may differ from Image

Approvals**Contact Layout**

The information in this brochure has been compiled with the utmost care.

Liability for the correctness completeness and topicality of the information is restricted to gross negligence. Version: 11/20

PIN 1	(+)
PIN 2	(NC)/(S2)
PIN 3	(-)
PIN 4	(NO)/(S1)
PIN 5	(Earth)
LED display	LED (green): Power / LED (yellow): (S1) / LED (white): Signal (S2)
General data	
Temperature range	-20...+70 °C, depending on cable quality
Cables	
Cable number	398
No./diameter of wires	16× 0.34 + 3× 0.75 mm ²
Wire isolation	PVC
C-track properties	2 Mio.
Jacket Color	gray
Material (jacket)	PUR/PVC (UL/CSA)
Outer Ø	10.0 mm ±5%
Bend radius (moving)	10× outer Ø
Cable identification	398
Cable Type	2 (PUR/PVC)
Approval (cable)	UL (AWM-Style 21441/10955), CE conform
Cable weight [g/m]	165,0
Material (wire)	Cu wire, bare
Resistor (core)	max. 57 Ω/km (0.34 mm ²), max. 26 Ω/km (0.75 mm ²); (20 °C)
Single wire Ø (core)	0.15 mm
Construction (core)	19× 0.15 mm (0.34 mm ²); 42× 0.15 mm (0.75 mm ²); (multi-strand wire class 5/6)
Diameter (core)	16× 0.34 + 3× 0.75 mm ²
AWG	similar to AWG 22 (0.34 mm ²); similar to AWG 19 (0.75 mm ²)
Material (wire isolation)	PVC
Material property (wire isolation)	CFC-, cadmium-, silicone- and lead-free
Shore hardness (wire isolation)	43 ±5 D
Wire-Ø incl. isolation	1.3 mm ±5% (0.34 mm ²); 1.8 mm ±5% (0.75 mm ²)
Color/numbering of wires	wh, grpk, brgn, ye, whgn, gn, rdbl, vi, grbr, bk, whgr, rd, yebr, pk, whye, gr-bl, br, gnye longitudinally striped
Shield	no
Material (jacket)	PUR/PVC
Shore hardness (jacket)	87 ±5 A
Outer-Ø (jacket)	10.0 mm ±5%
Color (jacket)	gray
chemical resistance	good resistance to oil, gasoline and chemicals (EN 60811-404)
Nominal voltage	U0/U 300/300 V AC
Test voltage	2000 V AC
Current load capacity	to DIN VDE 0298-4
Temperature range (fixed)	-30...+80 °C
Temperature range (mobile)	-5...+60 °C
Bend radius (fixed)	5× outer Ø
Bend radius (moving)	10× outer Ø
No. of bending cycles (C-track)	max. 2 Mio. (25 °C)
Traversing distance (C-track)	max. 5 m (horizontal)
Travel speed (C-track)	max. 2 m/s

Acceleration (C-track) max. 10 m/s²

Technical Data

Operating voltage	24 V DC
Operating current per contact	max. 4 A
Total current	max. 8 A
Locking of ports	Screw thread (M12×1 mm)
Protection	IP65/IP67
Housing	Plastic, flame retardant

Commercial data

country of origin	DE
customs tariff number	85444290
EAN	4048879054010
eClass	27143423
Packaging unit	1

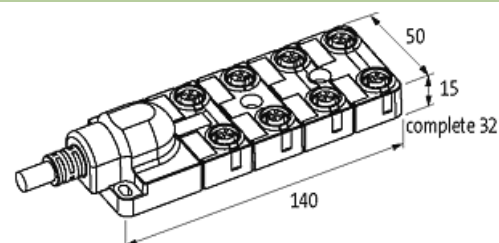
Sketch

Product may differ from Image