

## MVP12, 4XM12, UNIVERSAL

Universal distr.box, pins 1:1 to term.

### 4-way UNIVERSAL

Spring clamp plug-in terminals

all 5 contacts of the M12 females separately carried on terminals

Replaces identical product (Art.No. 277303)

Separation contact 5 possible by removable plug links

Plastic housings with good resistance against chemicals and oils.

The resistance to aggressive media should be individually tested for your application. Further details on request.

### [Link to Product](#)

#### Illustration



M12-Females 5-pole

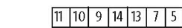
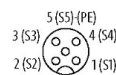

bridge 1

bridge 2

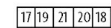
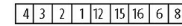

bridge 3

bridge 4

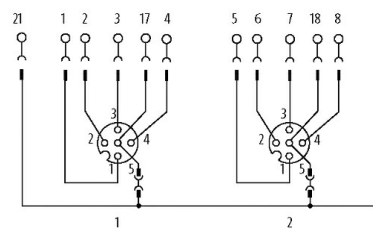

free arrangeable, contact 1:1 on terminals  
for 5 signals per port, possibility to bridge each PIN5

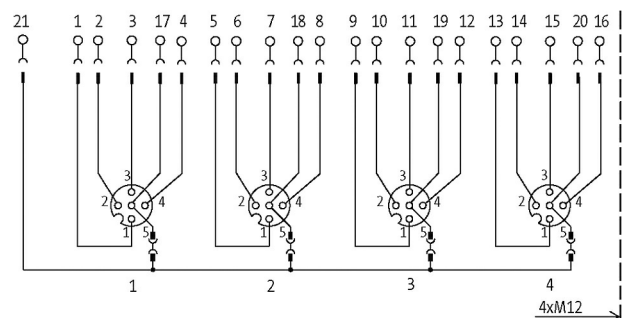

Product may differ from Image

### Approvals

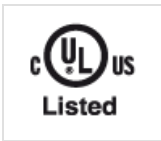

### Contact Layout

PIN 1	(S1)
PIN 2	(S2)
PIN 3	(S3)
PIN 4	(S4)
PIN 5	(S5)/(Earth)

### General data

Temperature range	-20...+80 °C
-------------------	--------------

### Technical Data

Operating voltage	max. 42 V AC/DC
Operating current per contact	max. 4 A
Total current	max. 8 A
Connection	Spring clamp plug-in terminals: max. 1.5 mm <sup>2</sup> (AWG 16)
Protection	IP65/IP67
Housing	Plastic, flame retardant

### Commercial data

country of origin	DE
customs tariff number	85369010
EAN	4048879353366
eClass	27279219
Packaging unit	1

### Sketch

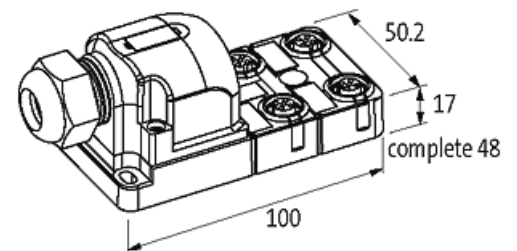

Product may differ from Image