

**MSUD VALVE PLUG FORM CI 9.4 MMSMALL.**

PVC 3X0.75 black 5m

MSUD

Form CI (9.4 mm)

24 V AC  $\pm 20\%$  / DC  $\pm 25\%$

LED and suppression

Further cable lengths on request.

Plastic housings with good resistance against chemicals and oils.

The resistance to aggressive media should be individually tested for your application. Further details on request.

[Link to Product](#)

Illustration

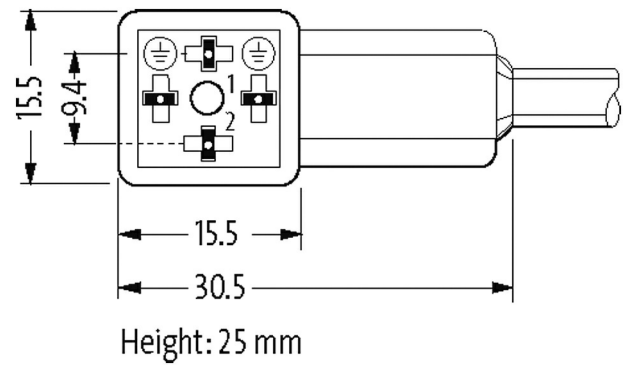

Product may differ from Image

**Approvals****Form**

Form

94031

**General data**

Temperature range -25...+85 °C, depending on cable quality

<b>Cables</b>	
No./diameter of wires	3 × 0.75 mm <sup>2</sup>
Wire isolation	PVC (bk num, gnye)
Material (jacket)	PVC
Outer Ø	5.9 mm ±5%
Bend radius (moving)	10 × outer Ø
Temperature range (fixed)	-30...+70 °C
Temperature range (mobile)	-5...+70 °C
Cable identification	616
Cable Type	1 (PVC)
Approval (cable)	CE conform
Cable weight [g/m]	61,60
Material (wire)	Cu wire, bare
Resistor (core)	max. 26 Ω/km (20 °C)
Single wire Ø (core)	0.2 mm
Construction (core)	24 × 0.2 mm (multi-strand wire class 5)
Diameter (core)	3 × 0.75 mm <sup>2</sup>
AWG	similar to AWG 18
Material (wire isolation)	PVC
Material property (wire isolation)	CFC-, cadmium-, silicone- and lead-free
Shore hardness (wire isolation)	43 ±5 D
Wire-Ø incl. isolation	1.8 mm ±5%
Color/numbering of wires	bk numbered, gnye longitudinally striped
Stranding combination	3 wires twisted
Shield	no
Material (jacket)	PVC
Material property (jacket)	CFC-, cadmium-, silicone- and lead-free
Shore hardness (jacket)	80 ±5 A
Outer-Ø (jacket)	5.9 mm ±5%
Color (jacket)	black
chemical resistance	good resistance to oil, gasoline and chemicals
Nominal voltage	300/500 V AC
Test voltage	3000 V AC
Current load capacity	to DIN VDE 0298-4
Temperature range (fixed)	-30...+70 °C
Temperature range (mobile)	-5...+70 °C
Bend radius (fixed)	5 × outer Ø
Bend radius (moving)	10 × outer Ø
Jacket Color	black
<b>Technical Data</b>	
Operating voltage	24 V AC ±20% / DC ±25%
Operating current per contact	max. 4 A
Switch off peak	max. 55 V
Switch off delay time	max. 20 ms
Locking of ports	M3 (recommended torque 0.4 Nm)
Protection	IP66K, IP67 inserted and tightened (EN 60529)
Housing	Black plastic (gray on request)

Rated surge voltage	0.8 kV
---------------------	--------

**Commercial data**

country of origin	CZ
customs tariff number	85444290
EAN	4048879114936
eClass	27279218
Packaging unit	1