

M8 MALE 90° 3 POLE / MSUD VALVE PLUG FORM B 10 MM

PVC 3X0.34 YELLOW, 2m

MSUD

Plastic housings with good resistance against chemicals and oils.

Form B (10 mm)

Male M8

90°

24 V AC $\pm 20\%$ / DC $\pm 25\%$

3-pole

Z-Diode + LED

Art-No. 7005 - M8 Lite - (plastic hexagonal screw) on request

Further cable lengths on request.

[Link to Product](#)

Illustration

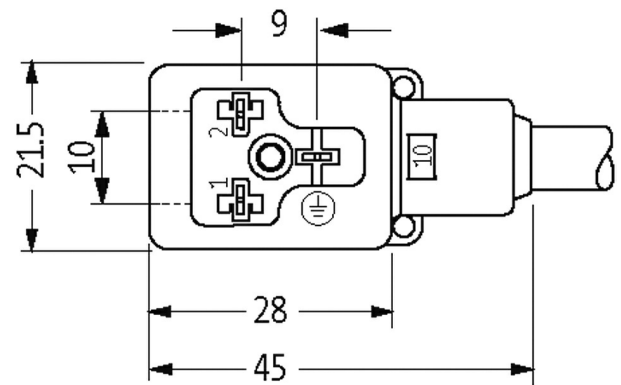
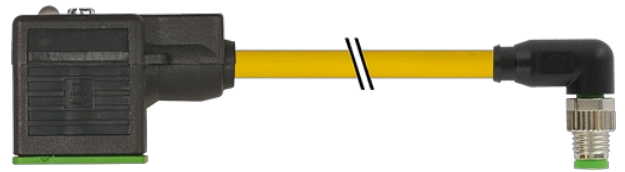

Height: 30 mm

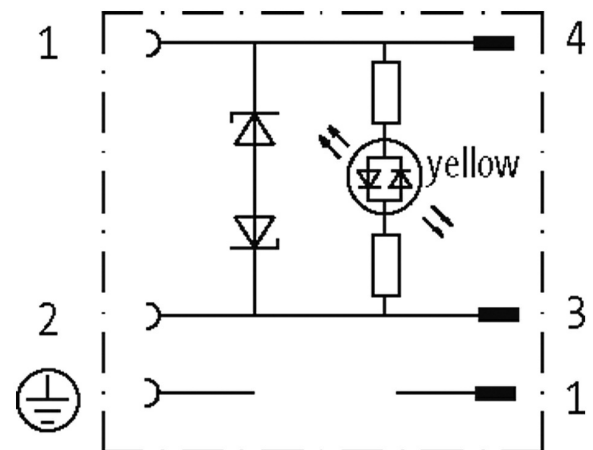

Product may differ from Image

Approvals



Form

Form 88761

General data

Standards	DIN EN 61076-2-104 (M8)
Mounting method	inserted, tightened
Material (contact)	Copper alloy
Material (contact surface)	MSUD (Ag); M8 (Au)
Material (gasket)	PUR
Pollution Degree	3

Temperature range -25...+85 °C, depending on cable quality

Cables	
No./diameter of wires	3 × 0.34 mm ²
Wire isolation	PVC (br, bl, bk)
Material (jacket)	PVC (UL/CSA)
Outer Ø	4.6 mm ±5%
Bend radius (moving)	10 × outer Ø
Temperature range (fixed)	-30...+80 °C
Temperature range (mobile)	-5...+80 °C
Cable identification	013
Cable Type	1 (PVC)
Approval (cable)	UL (AWM-Style 2464/1731), CSA
Cable weight [g/m]	34,10
Material (wire)	Cu wire, bare
Resistor (core)	max. 60 Ω/km (20 °C)
Single wire Ø (core)	0.15 mm
Construction (core)	19 × 0.15 mm (multi-strand wire class 5)
Diameter (core)	3 × 0.34 mm ²
AWG	similar to AWG 22
Material (wire isolation)	PVC
Material property (wire isolation)	CFC-, cadmium-, silicone- and lead-free
Shore hardness (wire isolation)	45 ±5 D
Wire-Ø incl. isolation	1.25 mm ±5%
Color/numbering of wires	br, bk, bl
Stranding combination	3 wires twisted
Shield	no
Material (jacket)	PVC
Material property (jacket)	CFC-, cadmium-, silicone- and lead-free
Shore hardness (jacket)	85 ±5 A
Outer-Ø (jacket)	4.6 mm ±5%
Color (jacket)	yellow
chemical resistance	good resistance to oil, gasoline and chemicals
thermal resistance	flame retardant UL 1581 VW1 / CSA FT1
Nominal voltage	UL 300 V AC
Test voltage	2000 V AC
Current load capacity	to DIN VDE 0298-4
Temperature range (fixed)	-30...+80 °C
Temperature range (mobile)	-5...+80 °C
Bend radius (fixed)	5 × outer Ø
Bend radius (moving)	10 × outer Ø
Jacket Color	yellow
Technical Data	
Operating voltage	24 V AC ±20% / DC ±25%
Rated surge voltage	0.8 kV
Operating current per contact	max. 4 A
No. of poles	3
Current consumption	15 mA
Material group	IEC 60664-1, category I
Switch off peak	max. 55 V

LED display	yellow
Locking of ports	M3/M8 (recommended torque 0.4 Nm)
Compression gland	M8 (SW9)
Protection	IP65 and IP67 when plugged and screwed down (EN 60529)
Material	MSUD (PBT); M8 (PUR)
Locking material	Zinc die casting, matte nickel plated
suitable for corrugated tube (internal Ø)	6.5 mm
Housing	Black plastic (gray on request)
Additional suppressor	Diode/Z-Diode

Commercial data

country of origin	CZ
customs tariff number	85444290
EAN	4048879117210
eClass	27279218
Packaging unit	1

Sketch

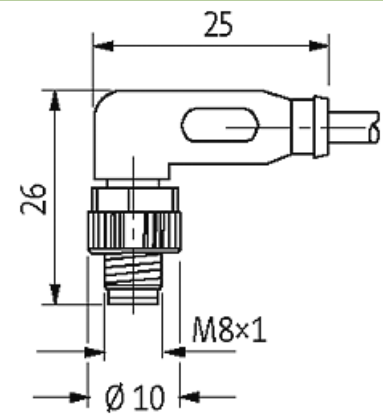

Product may differ from Image