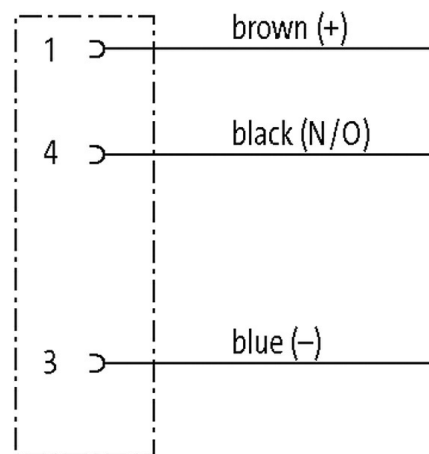
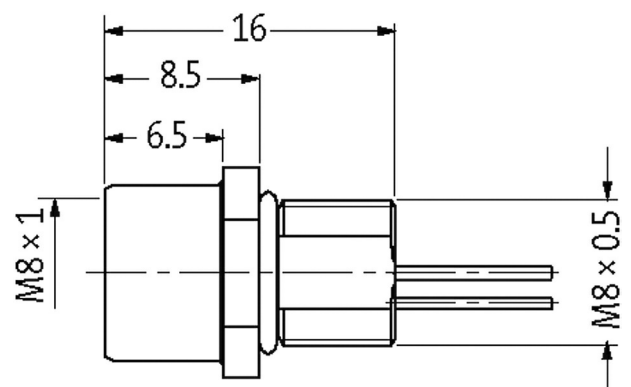
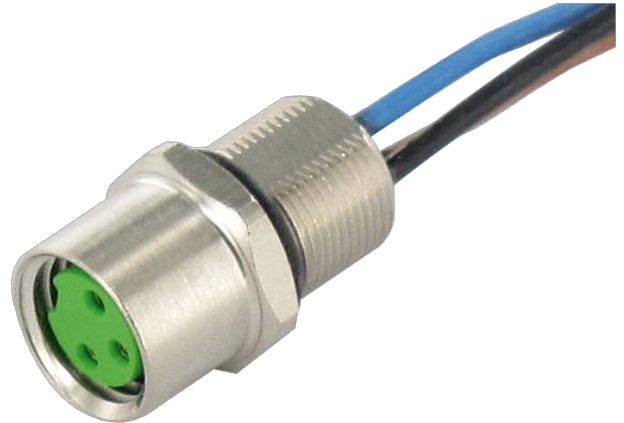

M8 female receptacle front mount incl. nut

wires PP 3x0.25 0.5m

Flange female
M8, 3-pole
Front mounting
with multi-strand wire

Illustration

Product may differ from Image

Approvals

**Form**

Form 08573

General data

Pollution Degree 3

Temperature range -25...+85 °C

Cables

Cable number 970

No./diameter of wires 3 × 0.25 mm²

Wire isolation PP (br, bk, bl)

Outer Ø 1.1 mm ±5%

Temperature range (fixed) -40...+90 °C

Temperature range (mobile) -25...+90 °C

Bend radius (fixed) 5 × outer Ø

Technical Data

Operating voltage max. 50 V AC/60 V DC

Rated surge voltage 1.5 kV

Operating current per contact max. 4 A

No. of poles 3

Material group IEC 60664-1, category I

LED display no

Locking of ports Screw thread (M8×1 mm) recommended torque 0.4 Nm, self-securing

Compression gland M8 (SW10)

Protection IP67 inserted and tightened (EN 60529)

Protection NEMA 3, 4, 6P (UL 50E)

Commercial data

country of origin DE

customs tariff number 85444290

EAN 4048879508209

eClass 27279220

Packaging unit 1

Sketch

Female

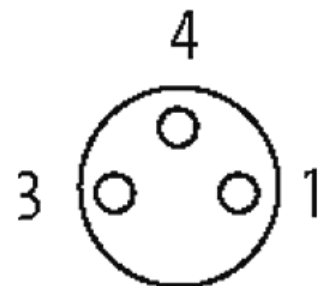

Product may differ from Image