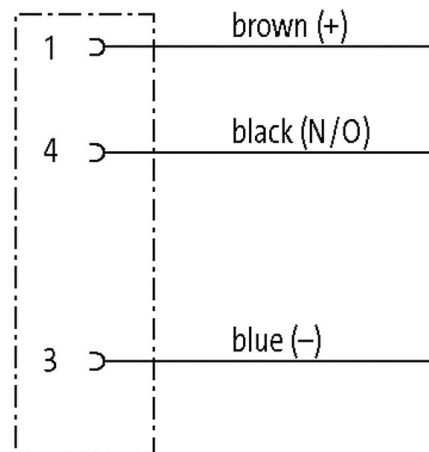
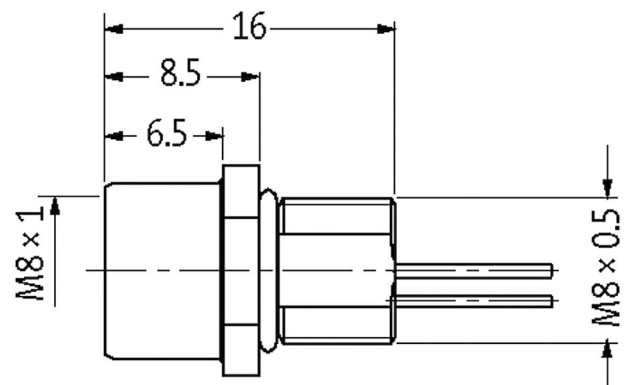
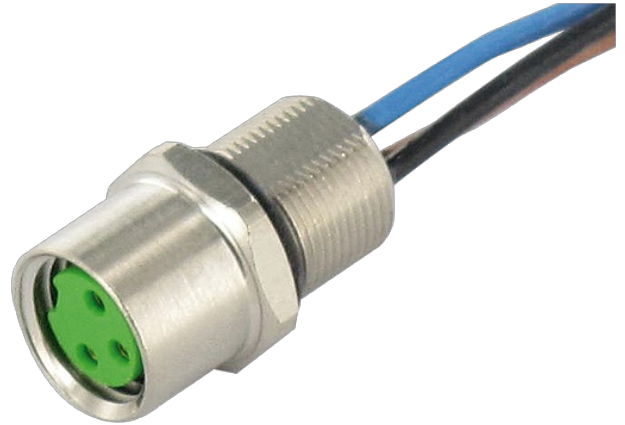

M8 FEMALE FLANGE PLUG A CODED FRONT MOUNT

PP-wires 3x0.25 0.3m

Flange female
M8, 3-pole
Front mounting
with multi-strand wire

Illustration

Product may differ from Image

Approvals

**Form**

Form 08571

General data

Standards DIN EN 61076-2-104 (M8)

Pollution Degree 3

Material (gasket) FKM

Temperature range -25...+85 °C

Cables

Cable number 970

No./diameter of wires 3× 0.25 mm²

Wire isolation PP (br, bk, bl)

Outer Ø 1.1 mm ±5%

Temperature range (fixed) -40...+90 °C

Temperature range (mobile) -25...+90 °C

Bend radius (fixed) 5× outer Ø

Technical Data

Operating voltage max. 50 V AC/60 V DC

Rated surge voltage 1.5 kV

Operating current per contact max. 4 A

Material group IEC 60664-1, category I

Locking of ports Screw thread (M8×1 mm) recommended torque 0.4 Nm, self-securing

Compression gland M8 (SW10)

Protection IP67 inserted and tightened (EN 60529)

Protection NEMA 3, 4, 6P (UL 50E)

Locking material Brass, nickel plated

Material Brass, nickel plated

Commercial data

country of origin DE

customs tariff number 85444290

EAN 4048879493505

eClass 27279220

Packaging unit 1

Sketch

stay connected

Female

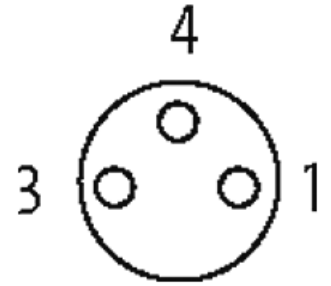

Product may differ from Image