

2-Point Inside Measuring Instrument

Item number: 511-435-20

Images

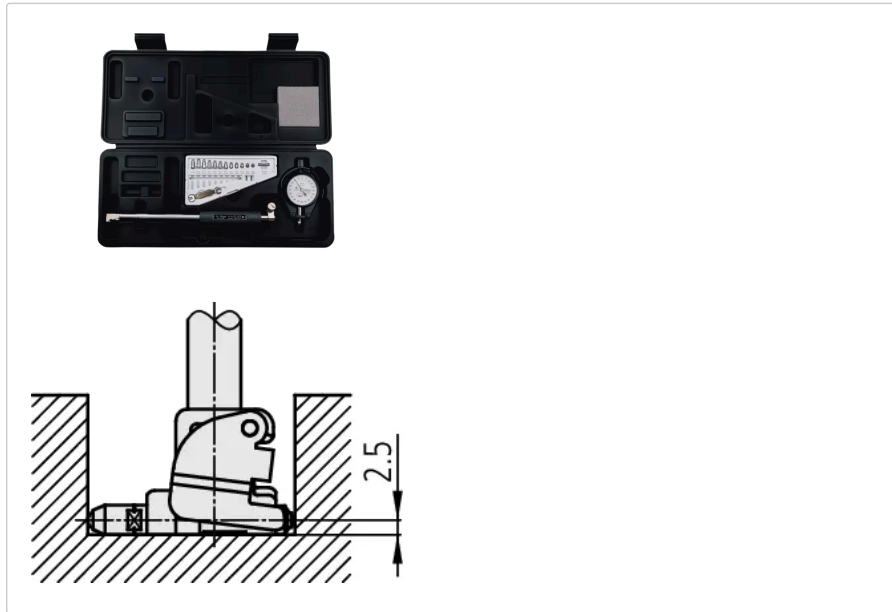

Description

This is a bore gauge for measuring blind holes that offers you the following benefits:

- You can measure the inside diameter close to the bottom of blind holes.
- Contact points are carbide giving you high durability and wear resistance.

Features

Inch-Metric:	Metric
Digital/Analog:	Analog
Range:	15 - 35 mm
Graduation:	0.001 mm
Stroke of contact point:	1.2 mm
Measuring depth:	150 mm
No. Dial Indicator:	2109AB
Accuracy:	4 μ m
Repeatability:	1 μ m
Delivered:	In a box with bore gauge 511-415, dial indicator 2109AB-10, plastic cover for indicator 21DZA000, 11 anvils, 1 interchangeable washer
Mass:	350 g

Dimensions

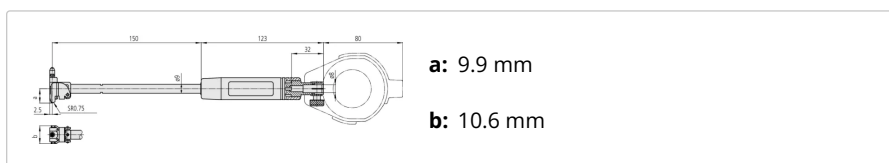

Accessories

Optional accessories:

Extension Rod Serie 511

125mm, 9mm Rod Diameter
Art No. 953549
Suggested retail price: 230.00 €*



Extension Rod Serie 511

250mm, 9mm Rod Diameter
Art No. 953550
Suggested retail price: 257.00 €*



Extension Rod Serie 511

500mm, 9mm Rod Diameter
Art No. 953551
Suggested retail price: 399.00 €*

Digital Indicator, Bore Gauge ID-C

12,7mm, 0,001mm, Flat Back Plate
Art No. 543-310B-10
Suggested retail price: 563.00 €*

Limit Hands (green) 2pcs

Dial Indicator Series 2/3/4
Art No. 21AZB195
Price on application



2-Point Inside Measuring Instrument

Bore Gauge for Blind Holes, 15-35mm, w/o Indicator

Art No. 511-415

Suggested retail price: 420.00 €*



Dial Gauge, Flat Back, ISO Type

Jewelled Bearing, Shockproof, 1mm, 0,001mm

Art No. 2109AB-10

Suggested retail price: 106.00 €*



Protector for Indicator (plastic cover)

Art No. 21DZA000

Suggested retail price: 20.00 €*

ANVIL NO.1 FOR BORE GAGE

511-

Art No. 21DZA376A

[Price on application](#)



ANVIL NO.2 FOR BORE GAGE

511-4xx

Art No. 21DZA376B

[Price on application](#)





ANVIL NO.3 FOR BORE GAGE

511-4xx
Art No. 21DZA376C
Price on application

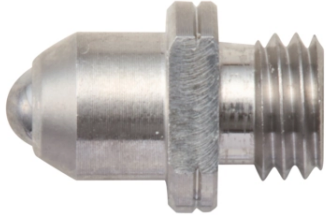

ANVIL NO.4 FOR BORE GAGE

511-4xx
Art No. 21DZA376D
Price on application



ANVIL NO.5 FOR BORE GAGE

511-4xx
Art No. 21DZA376E
Price on application



ANVIL NO.6 FOR BORE GAGE

511-4xx
Art No. 21DZA376F
Price on application



ANVIL NO.7 FOR BORE GAGE

511-4xx
Art No. 21DZA376G
Price on application



ANVIL NO.8 FOR BORE GAGE

511-4xx
Art No. 21DZA376H
Price on application



ANVIL NO.9 FOR BORE GAGE

511-4xx
Art No. 21DZA376J
Price on application



ANVIL NO.10 FOR BORE GAG

E 511-4xx
Art No. 21DZA376L
Price on application



ANVIL NO.11 FOR BORE GAG

E 511-4xx
Art No. 21DZA376M
Price on application



Washer 0.5mm/.02"/511

Art No. 212127
Price on application



SUB ANVIL FOR BORE GAGE

Art No. 21DAA563

Price on application



Spanner/511

Art No. 204354

Price on application