

## Gauge Stand with Granite Base

Item number: 215-151-10

### Images



### Description

With wear-resistant hard rock table

### Features

<b>Column Ø:</b>	30 mm
<b>Max. measurement height:</b>	260 mm
<b>Fine adjustment:</b>	1 mm
<b>Stem hole ø:</b>	ø 3/8" / <b>9.53 mm</b> , 8 mm with bush (standard accessory)
<b>Table flatness:</b>	3 µm
<b>Perpendicularity table-stem hole:</b>	0.2/100 mm/mm
<b>Delivered:</b>	With stem bush 9,53 mm (3/8") to 8 mm
<b>Mass:</b>	7.5 kg

### Dimensions

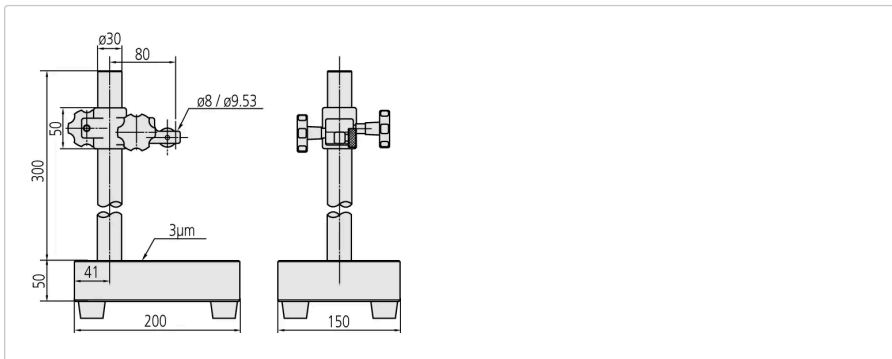

### Accessories

Standard accessories:



## Stem Bush for Gauge Stand

9,53mm to 8mm

Art No. 21JAA316

Suggested retail price: 37.30 €\*  

---