

## Internal Dial Caliper Gauge

Item number: 209-901

### Images

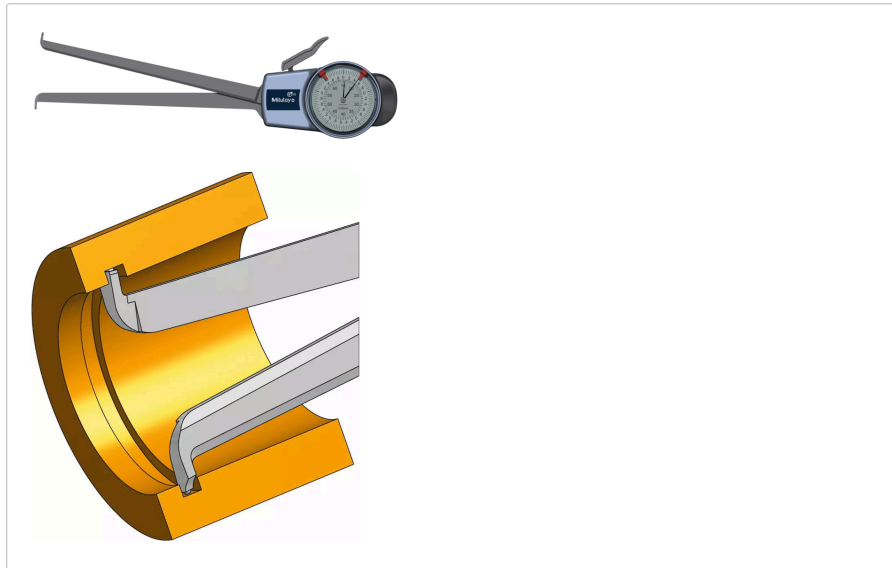

### Description

This analog Internal Dial Caliper Gauge offers you the following benefits:

- Excellent resistance against water and dust (IP65 protection level)
- Optimized measuring force
- Ergonomically designed to lie securely in your hand when measuring

### Features

<b>Inch-Metric:</b>	Metric
<b>Delivered:</b>	In a paper box with certificate of inspection
<b>Range:</b>	15 - 65 mm
<b>Type:</b>	Fig. 4
<b>Graduation:</b>	0.05 mm
<b>Measuring force:</b>	0,9-1,9 N
<b>Mass:</b>	355 g

### Dimensions

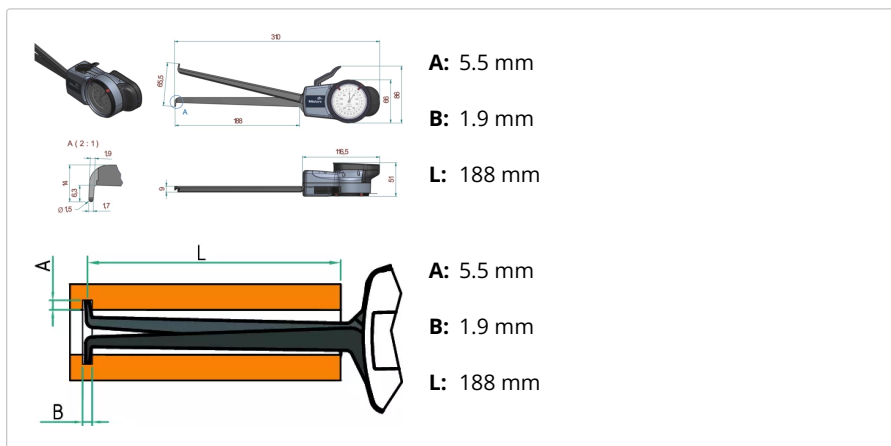

### Accessories

Optional accessories:



## Holder for Digital Caliper Gauge

for 209-901 up to 209-922

Art No. 63AAA437

Suggested retail price: 197.00 €\*  

---