

Internal Dial Caliper Gauge

Item number: 209-310

Images

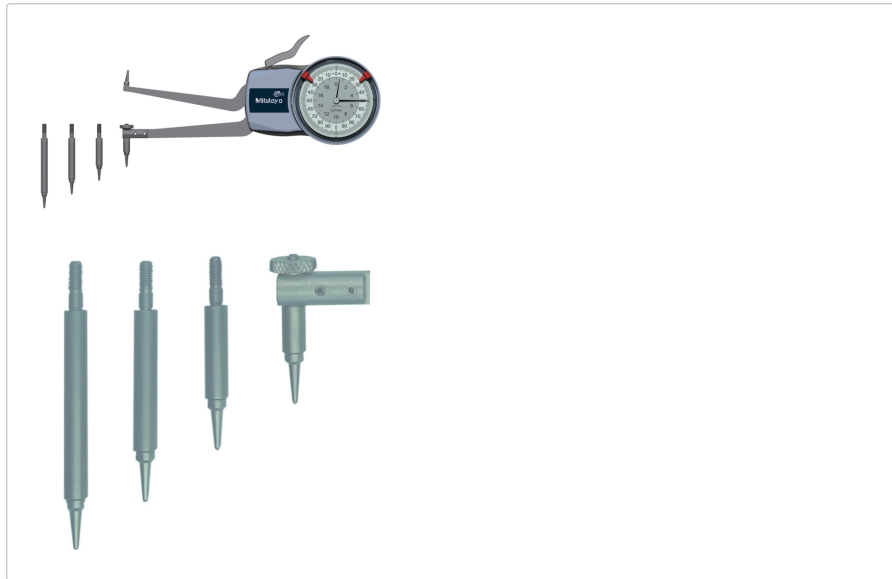

Description

This analog Internal Dial Caliper Gauge offers you the following benefits:

- Excellent resistance against water and dust (IP65 protection level)
- Optimized measuring force
- Ergonomically designed to lie securely in your hand when measuring

Features

Inch-Metric:	Metric
Delivered:	In a paper box with certificate of inspection
Range:	50 - 100 mm
Type:	Fig. 5
Graduation:	0.01 mm
Measuring force:	1,1-1,6 N
Mass:	220 g

Dimensions

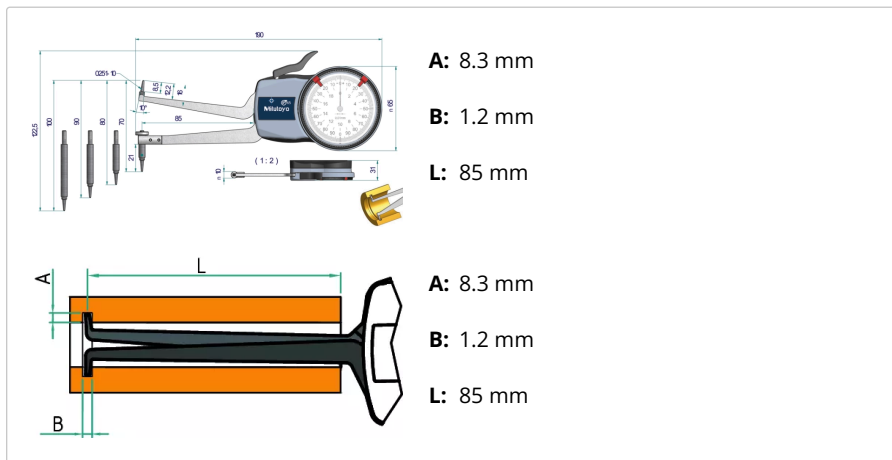

Accessories

Optional accessories:



Holder for Digital Caliper Gauge

for 209-901 up to 209-922
Art No. 63AAA437
Suggested retail price: 197.00 €*



Holder for Digital Caliper Gauge

for 209-300 up to 209-457 except: 209-310,
-311, -312, -361, -362, -363
Art No. 011530
Suggested retail price: 181.00 €*
