

Features

- Allows KOHLER® Invigoration® steam generator to be controlled via the DTV+™ and Anthem+™ digital showering systems
- For use with Kohler Invigoration® Series steam generators between 5 and 15 kilowatts
- Adjustable temperature settings between 90°F and 125°F
- Aromatherapy reservoir on steam heads
- Includes steam head, temperature sensor, and adapter
- Circular steam head design allows steam to be evenly dispensed throughout shower
- 20-minute safety shutoff
- Quick-connect RJ-12 cord and connector for simplified installation and service
- Not compatible with other manufacturers' steam generators
- Requires Anthem+ controller module, Anthem+ digital control, and choice of steam generator, or DTV+ controller module, DTV+ digital interface, and choice of steam generator

Material

- KOHLER finishes resist corrosion and tarnishing

Required Products/Accessories

K-27756 System controller module
K-28214-ASC Digital control
K-32324 5 kW steam generator

or

K-32327 11 kW steam generator

or

K-32328 13 kW steam generator

or

K-32329 15 kW steam generator

or

K-27756 System controller module
K-28214-ASC Digital control
K-32325 7 kW steam generator

or

K-27756 System controller module
K-28214-ASC Digital control
K-32326 9 kW steam generator

or

K-27756 System controller module
K-28214-ASC Digital control
K-32327 11 kW steam generator

or

K-27756 System controller module
K-28214-ASC Digital control
K-32328 13 kW steam generator

or

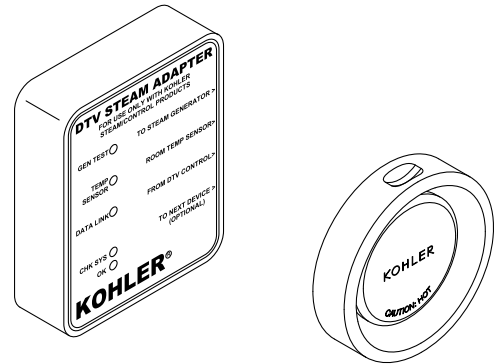

Codes/Standards







None Applicable

KOHLER® Electronic Faucets, Valves, and Controls Five-Year Limited Warranty

See website for detailed warranty information.

Available Colors/Finishes

Color tiles intended for reference only.

Color	Code	Description
	CP	Polished Chrome
	SN	Vibrant® Polished Nickel
	AF	Vibrant® French Gold
	BV	Vibrant® Brushed Bronze
	BL	Matte Black
	BGP	Vibrant Brushed Graphite

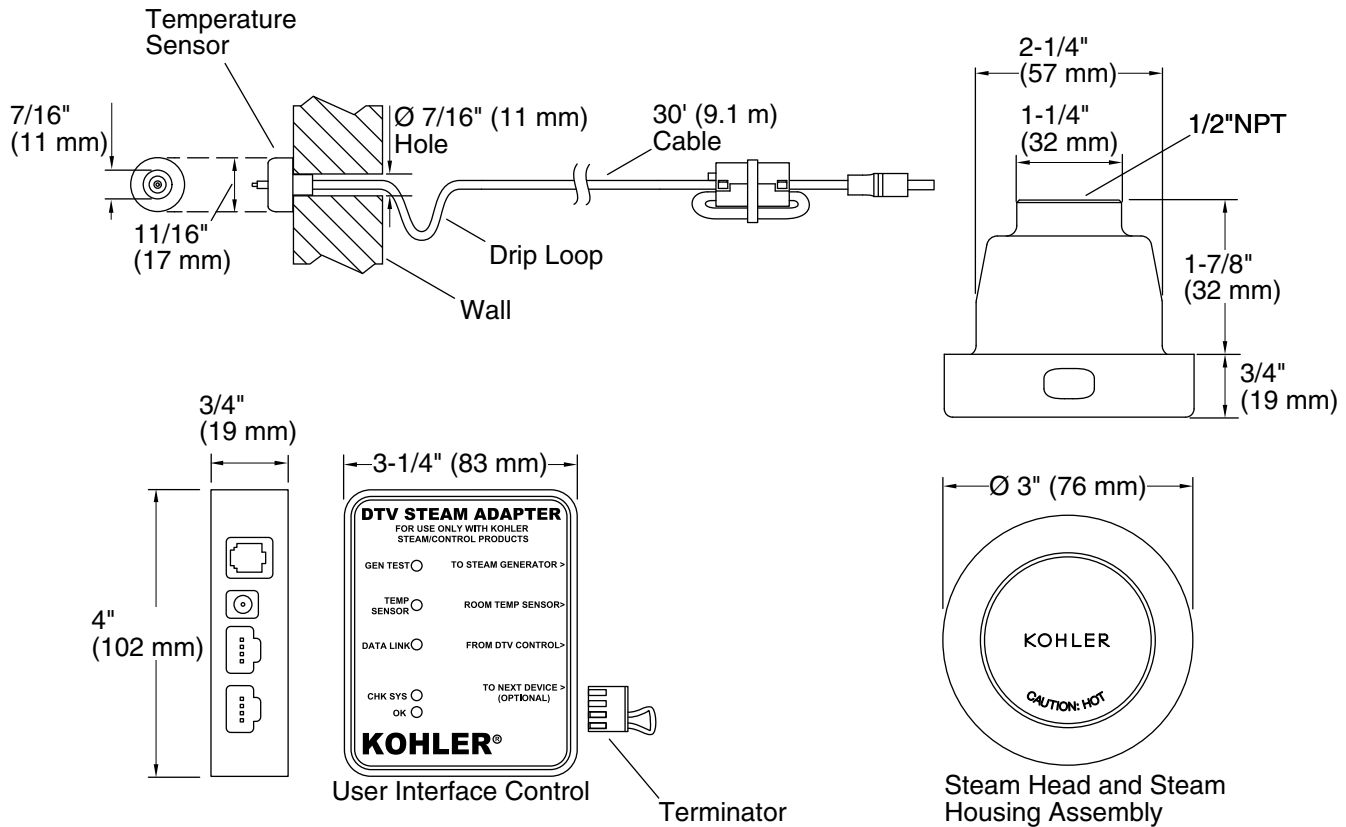

Technical Information

All product dimensions are nominal.

Spout:

Notes

Install this product according to the installation guide.

CAUTION: Risk of scalding. Do not locate the steam head near a seat or bench, as the steam head is hot during operation and may scald the user if touched.

The temperature sensor should be mounted on the wall opposite the steam head. The steam head should be located as far from the seating area as possible.

Locate the steam head 6" (152 mm) above the floor and at least $4\frac{1}{2}$ " (114 mm) from the threshold.