

# IDEM WPR and WMR Heavy Duty Non-Contact Magnetic Safety Switches

## WPR Series Plastic Housing

## WMR Series Stainless Steel Housing



- Robust wide housing suitable for all industry applications
- Can be high-pressure hosed at high temperature - IP69K rated
- Wide 12 mm sensing, high tolerance to misalignment
- High switching capability - up to 2A
- Will operate with most safety relays
- Codes are not unique and can be used with other models of the same series
- Available with 2m or 5m cable or 250mm pigtail with quick-disconnect cable

### WMR Series only

- Specifically designed for food processing applications
- Suitable for CIP SIP cleaning - Food Splash Zones per EHEDG guidelines
- 316 Stainless steel mirror polished finish
- Can be high-pressure hosed at high temperature - IP69K rated

See Dimensions later in this section.

### Actuator Operating Direction

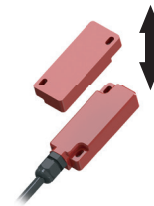

| WPR/WMR Non-Contact Magnetic Safety Switches |          |                 |              |            |                       |
|--|----------|-----------------|--------------|------------|-----------------------|
| Part Number                                  | Price    | Body Material   | Cable Length | Circuits   | Contact Type / Rating |
| <b>Pigtail Versions</b>                      |          |                 |              |            |                       |
| <a href="#"><u>WPR-112005</u></a>            | \$149.00 | Plastic         | 2m           | 2 NC, 1 NO | Heavy duty / 2A       |
| <a href="#"><u>WPR-112006</u></a>            | \$158.00 |                 | 5m           |            |                       |
| <b>Quick Disconnect Versions (M12 8-pin)</b> |          |                 |              |            |                       |
| <a href="#"><u>WPR-112008</u></a>            | \$179.00 | Plastic         | 250mm        | 2 NC, 1 NO | Heavy duty / 2A       |
| <a href="#"><u>WMR-136008</u></a>            | \$232.00 | Stainless Steel | 250mm        |            |                       |

| Female Quick Disconnect Lead  |         |                |                        |
|-------------------------------|---------|----------------|------------------------|
| Part Number                   | Price   | Description    | Exit Type/Cable Length |
| <a href="#"><u>140101</u></a> | \$53.00 | Female QD Lead | M12 Female 5m, 8-pin   |
| <a href="#"><u>140102</u></a> | \$80.00 |                | M12 Female 10m, 8-pin  |



# IDEM WPR and WMR Heavy Duty Non-Contact Magnetic Safety Switches

## Dimensions

mm [in]

### WPR Series

#### Pigtail

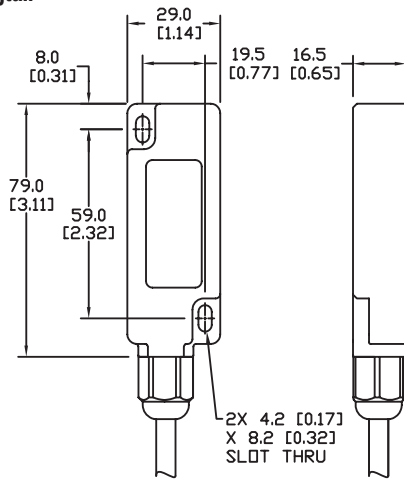

SWITCH

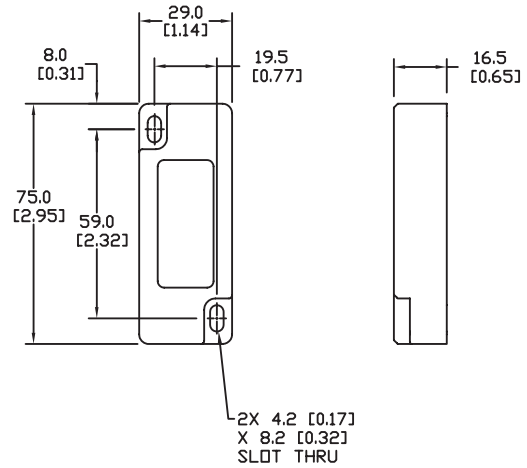

ACTUATOR

#### Quick Disconnect

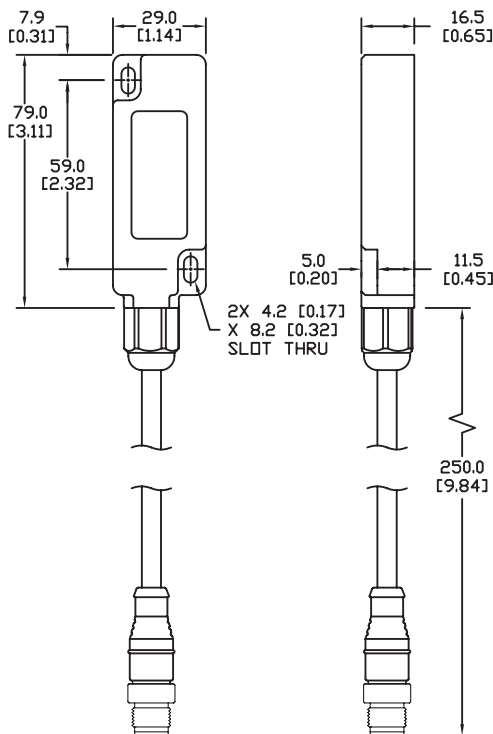

SWITCH

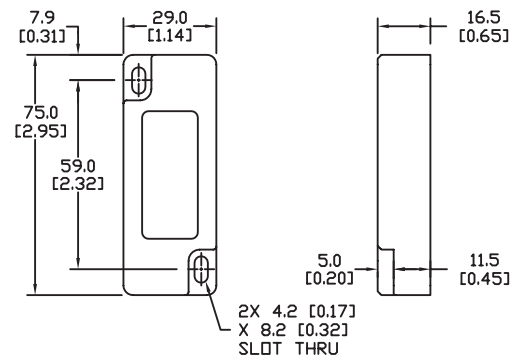

ACTUATOR

See our website: [www.AutomationDirect.com](http://www.AutomationDirect.com) for complete Engineering drawings.

# IDEM WPR and WMR Heavy Duty Non-Contact Magnetic Safety Switches

## Dimensions

mm [in]

### WMR Series

#### Quick Disconnect

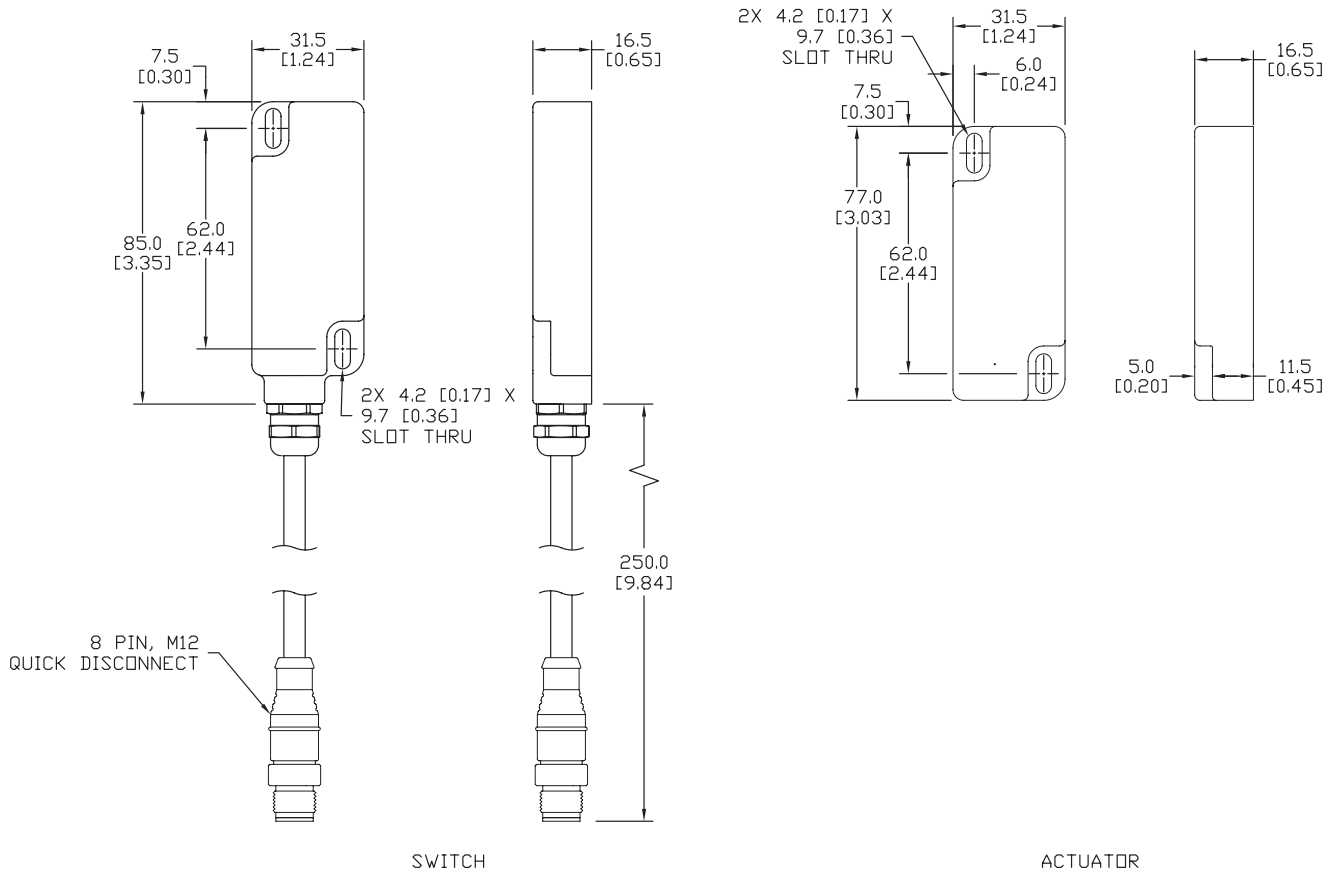

See our website: [www.AutomationDirect.com](http://www.AutomationDirect.com) for complete Engineering drawings.

# IDEM Non-Contact Safety Switches

## Electrical Connections and Dimensions

### Electrical Connections

#### Magnetic Switches

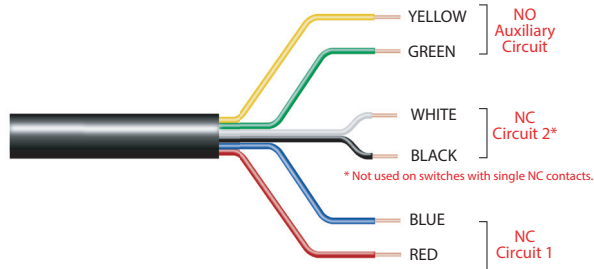

| Magnetic Switches - Electrical Connections |            |                                    |
|--|------------|------------------------------------|
| Quick Disconnect Connector Pin Out         | Lead Color | Type of Circuit (Actuator Present) |
| 4  | Yellow     | Auxiliary (NO)                     |
| 6  | Green      | Auxiliary (NO)                     |
| 7  | Black      | NC2                                |
| 1  | White      | NC2                                |
| 2  | Red        | NC1                                |
| 3  | Blue       | NC1                                |

#### Coded Magnetic and RFID Switches

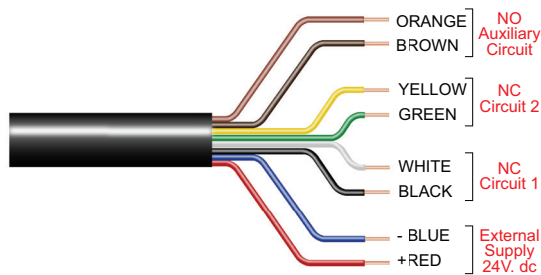

| Coded Magnetic Switches - Electrical Connections |            |                                    |                                  |
|--|------------|------------------------------------|----------------------------------|
| Quick Disconnect Connector Pin Out               | Lead Color | Type of Circuit (Actuator Present) | Output Types (Solid State)       |
| 8  | Orange     | Auxiliary (NO)                     | 200 mA max. 24 VDC               |
| 5  | Brown      | Auxiliary (NO)                     |                                  |
| 4  | Yellow     | NC2 +                              | 200 mA max. 24 VDC (Optocoupler) |
| 6  | Green      | NC2 -                              |                                  |
| 7  | Black      | NC1 +                              | 200 mA max. 24 VDC (Optocoupler) |
| 1  | White      | NC1 -                              |                                  |
| 2  | Red        | Supply +24 VDC                     | Supply 24 VDC +10% / -15%        |
| 3  | Blue       | Supply 0VDC                        |                                  |

#### Connection Colors

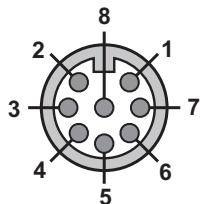

Pin View from Switch  
M12 Male

# IDEM Non-Contact Safety Switches Specifications

| Non-contact Safety Switches Specifications         |   |  |  |
|--|---|--|--|
|  | Non-Contact Magnetic Switches   | Non-Contact Coded Magnetic Switches                    | Non-Contact RFID Coded Switches        |
| <b>Safety Classification and Reliability Data</b>  |   |  |  |
| Switching Reliability (B10d)                       | 3.3 x 10 <sup>6</sup> operations at 100mA load  | No mechanical parts implemented                        | No mechanical parts implemented        |
| ISO 13849-1  | Up to Category 4  |  |  |
| ISO 13849-1  | Up to PLe depending upon system architecture  |  |  |
| EN 62061   | Up to SIL3 depending upon system architecture   |  |  |
| Safety Data - Annual Usage                         | 8 cycles per hour / 24 hours per day / 365 days   |  |  |
| PFHd   | 2.8 x 10 <sup>-10</sup>   | 2.6 x 10 <sup>-10</sup>                                | 4.77 x 10 <sup>-10</sup>               |
| Proof Test Interval (Life)                         | 20 years  |  |  |
| MTTFd  | 470 years   | 866 years  | 1100 years                             |
| Agency Approvals                                   | CE, cULus   |  |  |
| <b>Electrical and General Specifications</b>       |   |  |  |
| Contact Ratings: Safety Contact NC                 | MPR: Voltage free: 250VAC, 0.5 A max.   | 24VDC, 0.2 A max (optocoupler)                         | 24VDC, 0.2 A max (optocoupler)         |
|  | LPR, LMR, SPR, SMR, SMR-F:<br>Voltage free: 250VAC, 1.0 A max.  |  |  |
|  | CPR, CMR, CMR-F, WPR:<br>Voltage free: 250VAC, 2.0 A max.   |  |  |
|  | BPR, BMR:<br>240VAC, 24VAC/DC, 1.0 A max.   |  |  |
| Contact Ratings: Monitoring (Auxiliary) Contact NO | Voltage free: 24VDC, 0.2 A max.   | 24VDC, 0.2A max.                                       | 24VDC, 0.2A max.                       |
| Recommended Fuses (NC Circuits)                    | MPR: Fuse externally 0.4 A (F)  | NA   | NA                                     |
|  | LPR, LMR, SPR, SMR, SMR-F, CMR,<br>CMR-F: Fuse externally 0.8 A (F)   |  |  |
|  | CPR, WPR: Fuse externally 1.6 A (F)   |  |  |
|  | BPR, BMR:<br>Fuse externally 0.5 A (F)  |  |  |
| Contact Release Time                               | <2ms  | NA   | NA                                     |
| Initial Contact Resistance                         | <0.5 Ω  | NA   | NA                                     |
| Minimum Switched Current                           | 10 DC, 1mA  |  |  |
| Dielectric Withstand                               | 250VAC  |  |  |
| Insulation Resistance                              | 100 Megohms   |  |  |
| Recommended Setting Gap                            | 5mm [0.20 in]   |  |  |
| NC Switching Distance                              | Sao (assured ON) 8mm [0.31 in] close; Sar (assured OFF) 20mm [0.79 in] open                                 |  |  |
| NC Switching Operation                             | For all switches the NC circuits are closed when the guard is closed and the actuator is present.           |  |  |
| NO Switching Operation                             | Opens before NC circuits close  |  |  |
| Tolerance to Misalignment                          | 5mm [0.20 in] in any direction from 5mm [0.20 in] setting gap (See Misalignment Range drawing on this page) |  |  |
| Switching Frequency                                | 1.0 Hz Max.   |  |  |
| Approach Speed                                     | 200mm [7.87 in] per minute to 1000mm [39.37] per second   |  |  |
| Body Material - Polyester                          | CPR, LPR, MPR, SPR, WPR, BPR  | CPC, LPC, MPC, SPC, WPC                                | LPF, SPF, BPF                          |
| Body Material - 316 Stainless Steel                | CMR, CMR-F, LMR, SMR, SMR-F, BMR  | CMC, CMC-F, LMC, SMC, SMC-F                            | LMF, BMF                               |
| Operating Temperature Range                        | Polyester: -25° to +80°C (-13° to +176° F)  |  |  |
|  | 316 Stainless Steel: -25° to +105° C [-13° to +221° F]  | 316 Stainless Steel: -25° to +105° C [-13° to +221° F] | -25° to +80° C [-13° to +176° F]       |
| Storage Temperature (Low)                          | -55° to -40° C [-67° to -40° F]   |  |  |
| Enclosure Protection                               | IP67, IP69K (QC versions are IP67 due to connector)   |  |  |
| Shock Resistance                                   | IEC 68-2-27 11ms 30g  |  |  |
| Vibration Resistance                               | IEC 68-2-6 10-55 Hz 1mm [0.04 in]   |  |  |
| Cable Type   | PVC, 6.5 mm outside diameter max.   | PVC, 6.5 mm outside diameter max.                      | PVC, 6mm [0.24 in] outer diameter max. |
| Mounting Bolts (recommended)                       | 2 x M4; Tightening torque: 1.0 N•m [0.74 lb•ft]   |  |  |

Note: Always mount onto non-ferrous materials.

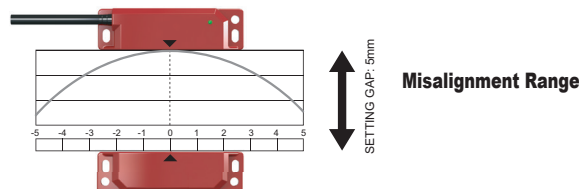

# Safety Products



*Warning: Safety products sold by AutomationDirect are Safety components only. The purchaser/installer is solely responsible for the application of these components and ensuring all necessary steps have been taken to assure each application and use meets all performance and applicable safety requirements and/or local, national and/or international safety codes as required by the application. AutomationDirect cannot certify that our products, used solely or in conjunction with other AutomationDirect or other vendors' products, will assure safety for any application. Any person using or applying any products sold by AutomationDirect is responsible for learning the safety requirements for their individual application and applying them, and therefore assumes all risks, and accepts full and complete responsibility, for the selection and suitability of the product for their respective application.*

*AutomationDirect does not provide design or consulting services, and cannot advise whether any specific application or use of our products would ensure compliance with the safety requirements for any application.*