

Switches, Single Pole
 20A, 347V AC
 HBL® Extra Heavy Duty Industrial Switch

HUBBELL

Features

- Large brass binding head screws with deep slots
- Abuse resistant nylon toggle
- Strip gauge for accurate wiring

Ordering Information

Description	Toggle Color	UPC	Catalog Number
Nylon toggle, back and side wired	Ivory	783585924779	HBL182211CN

Listings

UL Listed
 CSA Certified
 Fed. Spec. W-S-896

Specifications

Top Material	Thermoset
Base Material	Thermoset, Color Coded by Amperage
Toggle Material	Nylon
Contacts	Silver Alloy
Terminal Screws	Brass
Ground Screw	Brass (Green)

Performance

Electrical

Dielectric Voltage	Withstands 1500V AC minimum for 1 minute
Max. Continuous Current	20A
Max. Working Voltage	347V AC
Overload	Minimum 4.8 times rated current for 100 cycles
Temperature Rise	30°C maximum at rated current

Mechanical

Terminal Accommodations #14 AWG min. - #10 AWG max. solid and stranded copper wire only

Environmental

Flammability	UL 94V-2
Operating Temperature	Max. continuous: 75°C; Min. continuous: -40°C without impact

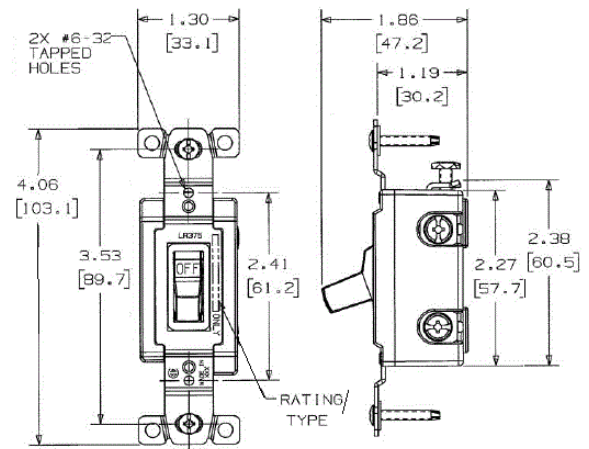

Online Resources

Customer Use Drawing
 eCatalog

Dimensions in Inches (mm)

Hubbell Wiring Device-Kellems • Hubbell Incorporated (Delaware) • 40 Waterview Drive • Shelton, CT 06484

Phone (800) 288-6000 • Fax (800) 255-1031 • Specifications subject to change without notice.

