

Product Specifications



Post Office Box 97
Benton Harbor, Michigan
Ph: 269/926-6171
Fax: 269/925-8288

PART NO.:
STD118A

REV.
A

Model Number	MAX. PRESS.		MAX. SPEED	HP	kW	Net Wt.	
	bar.	PSI				lbs.	kg
2AM-NCC-43ALL	5,6	80	2,000 RPM	.55	0.40	7.5	3.4

SOUND LEVEL 76 dba MAX.
 NORMAL AMBIENT +1°C. - 120°C.
 RELATIVE HUMIDITY 0% - 100%
 ENVIRONMENT HAZARDOUS AMBIENT COMBUSTIBLE
GAS AND DUST +1°C TO +40°C

CONFORMS TO EUROPEAN STD. EN13463-1 NON-ELECTRICAL EQUIPMENT FOR EXPLOSIVE ATMOSPHERES GROUP II, CAT. 2 (GAS & DUST) PROTECTED BY CONSTRUCTION (SURFACE TEMP. RATING 135°C)

- NOTES:
 1. CORROSION RESISTANT ROTOR ASSEMBLY.
 2. UNIVERSAL VANE MATERIAL FOR OPERATING WITH OR WITHOUT LUBRICATION.
 3. TECHNICAL DATA SUBJECT TO CHANGE WITHOUT NOTICE.

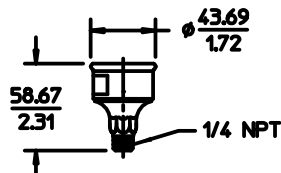
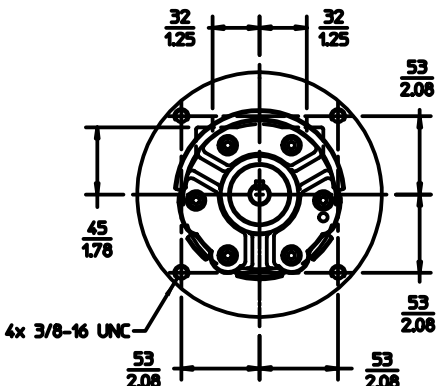
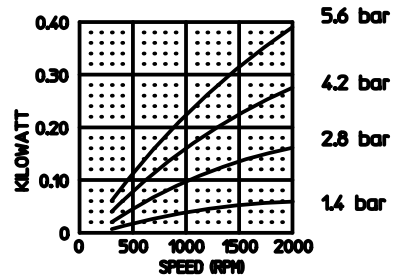
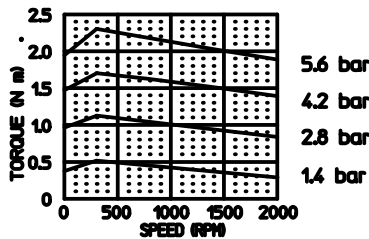
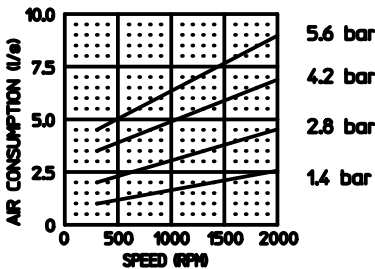
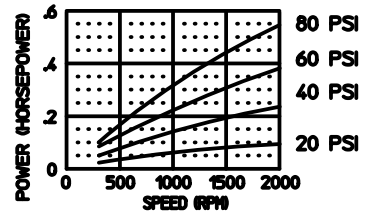
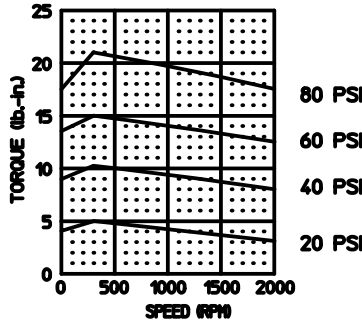
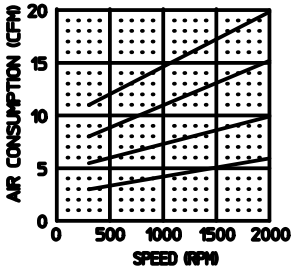

MUFFLER ASM. - UNATTACHED

