



Command 22mm Emergency Stop Pushbuttons



AR22VQR-01R



AR22VPR-12R



AR22VQL-01E3R



AR22VQL-12EAR



Command 22mm Emergency Stop Pushbuttons										
Part Number	Price	Drawing Link	Contacts	Operator	Voltage	Bulb type	Action	Legend	Protection	Material
AR22VQR-01R	\$26.00	PDF	(1) N.C.	40.0 mm, mushroom, red	—	—	Push to lock, pull or turn to reset	Arrow	IP65	Base: Plastic Bezel: Plastic
AR22VQR-12R	\$33.00	PDF	(1) N.O./ (2) N.C.							
AR22VPR-01R	\$33.00	PDF	(1) N.C.	65.0 mm, mushroom, red	—	—	Push to lock, pull or turn to reset	Arrow	IP65	Base: Plastic Bezel: Plastic
AR22VPR-12R	\$40.00	PDF	(1) N.O./ (2) N.C.							
AR22VQL-01E3R	\$35.00	PDF	(1) N.C.	40.0 mm, mushroom, red	24 VAC/VDC full voltage	LED illuminated	Push to lock, pull or turn to reset	Arrow	IP65	Base: Plastic Bezel: Plastic
AR22VQL-12E3R	\$42.00	PDF	(1) N.O./ (2) N.C.			Interlocked LED illuminated				
AR22VQL-01EAR	\$42.00	PDF	(1) N.C.							
AR22VQL-12EAR	\$49.00	PDF	(1) N.O./ (2) N.C.							



AR22V0R-01R



AR22V7R-01R



AR22Q2R-01R



AR22V0L-01E3R

Command 22mm Emergency Stop Pushbuttons											
Part Number	Price	Drawing Link	Contacts	Operator	Voltage	Bulb Type	Action	Legend	Protection	Material	
AR22V0R-01R	\$20.50	PDF	(1) N.C.	40.0 mm, mushroom red	—	—	Twist-to-release	Arrow	IP65	Base: Plastic Bezel: Plastic	
AR22V7R-01R	\$28.00	PDF	(1) N.C.				Key operated release				
AR22Q2R-01R	\$25.00	PDF	(1) N.C.	35.0 mm, mushroom, red	24 VAC/VDC full voltage	LED illuminated	Push to lock, pull to reset	—	IP65	Base: Plastic Bezel: Plastic	
AR22V0L-01E3R	\$31.50	PDF	(1) N.C.	40.0 mm, mushroom, red			115-127 VAC transformer	Twist-to-release			Arrow
AR22V0L-01L3R	\$37.00	PDF	(1) N.C.								
Accessory											
AR9P719-5A	\$8.25	PDF	Fuji Electric oversized legend plate, aluminum, round, yellow field, yellow background, black engraved text, legend plate marking "EMERGENCY STOP". For use with 22mm pilot devices.								



AR9P719-5A



Accessories for 22mm Command Series Pilot Devices

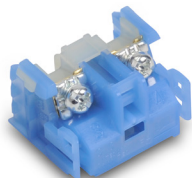

AR9B290

Contact Blocks for Command Series 22mm Pushbuttons					
Part Number	Qty	Price	Drawing Link	Color	Contacts
AR9B290	1	\$6.25	PDF	Blue	N.O.
AR9B291	1	\$6.25	PDF	Red	N.C.

Minimum current requirement AC/DC is 5mA

Terminal Layout

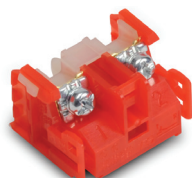

AR9B291

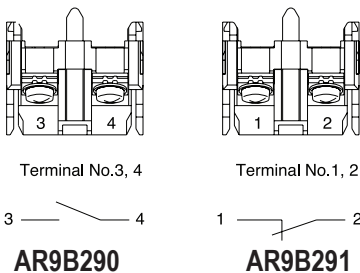

Max 6 contacts for non-illuminated momentary devices. Max 4 for alternate action non-illuminated devices. Max 5 contacts for illuminated momentary devices. Max 3 for alternate action illuminated devices. *Exceeding the maximum number of contacts could affect the mechanical durability of the operators.



APX510-24R

LED Bulbs for Command Series 22mm Pilot Devices								
Part Number	Color	Qty	Price	Use With	Lamp Voltage	Current Consumption	Power Consumption	Lamp Durability
APX510-24R	Red	2	\$15.50	AR22 / DR22 Series	24V AC/DC	12mA AC 11mA DC	0.8 W	30,000h
APX510-24G	Green	2	\$15.50					
APX510-24Y	Yellow	2	\$15.50					
APX510-24S	Blue	2	\$58.00					
APX510-24O	Orange	2	\$15.50					

*Lamp base: Ba9s/13

Lamp Replacement

Insert the tip of a small screwdriver into the slot between color knob and bezel.

Then pry knob up and remove.

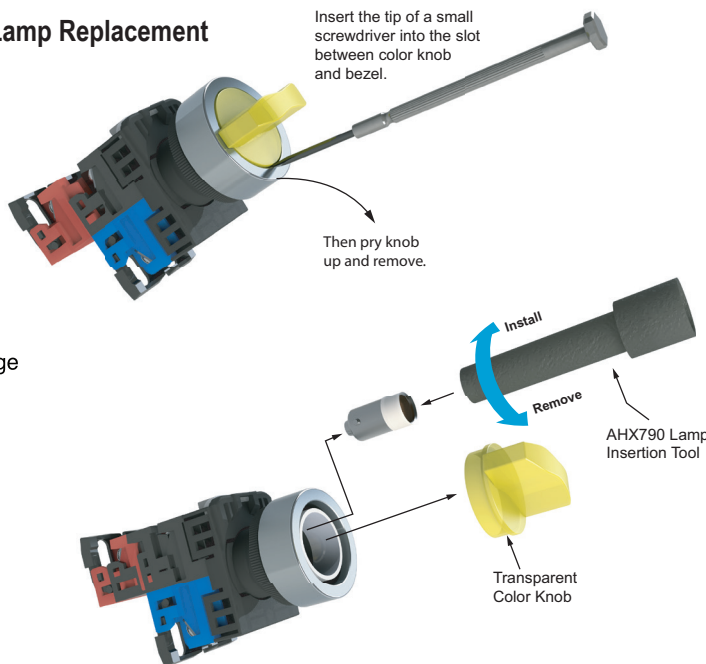

Estimated durability for LED lamps

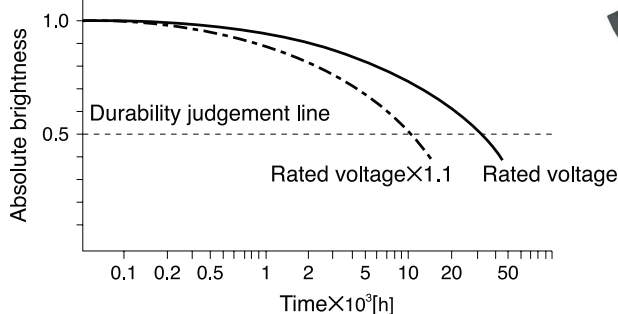

Notes: • Durability at Ta=25°C
• Durability is affected by temperature, humidity, and voltage fluctuation.

Accessories for 22mm Command Series Pilot Devices

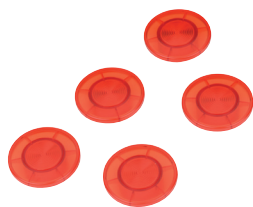

AR9C016-R

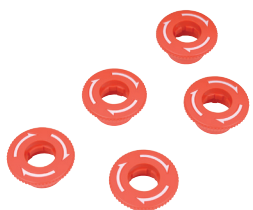

AR9C021-R

Lenses for Command Series 22mm Illuminated Pushbuttons					
Part Number	Color	Qty	Price	Drawing Link	Use With
AR9C016-R	Red	5	\$4.75	PDF	AR22MOL, AR22M5L
AR9C021-R	Red	5	\$14.50	PDF	AR22VOR, AR22VOL
AR9C011-R	Red	5	\$2.25	PDF	AR22FOL AR22F5L
AR9C011-G	Green	5	\$2.25	PDF	
AR9C011-Y	Yellow	5	\$2.25	PDF	
AR9C011-S	Blue	5	\$2.25	PDF	
AR9C011-C	Clear	5	\$2.25	PDF	AR22EOL
AR9C012-R	Red	5	\$2.25	PDF	
AR9C012-G	Green	5	\$2.25	PDF	
AR9C012-Y	Yellow	5	\$2.25	PDF	
AR9C012-S	Blue	5	\$2.25	PDF	
AR9C012-C	Clear	5	\$2.25	PDF	

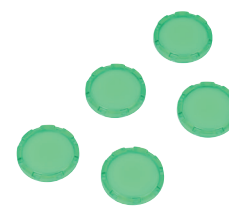

AR9C011-G

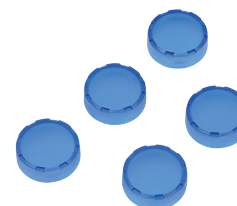

AR9C012-S

Tools and Lock Nut for Use with Command Series 22mm Pilot Devices				
Part Number	Qty	Price	Drawing Link	Description
AHX790	1	\$3.50	PDF	Bulb removal tool
AHX702	1	\$6.00	N/A	Wrench/lamp removal tool
AR9A004	1	\$4.75	N/A	Wrench
AR9R744	5	\$2.25	PDF	Lock nut



AHX790



AHX702

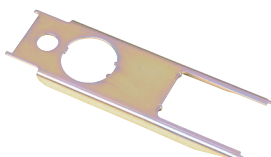

AR9A004



AR9R744

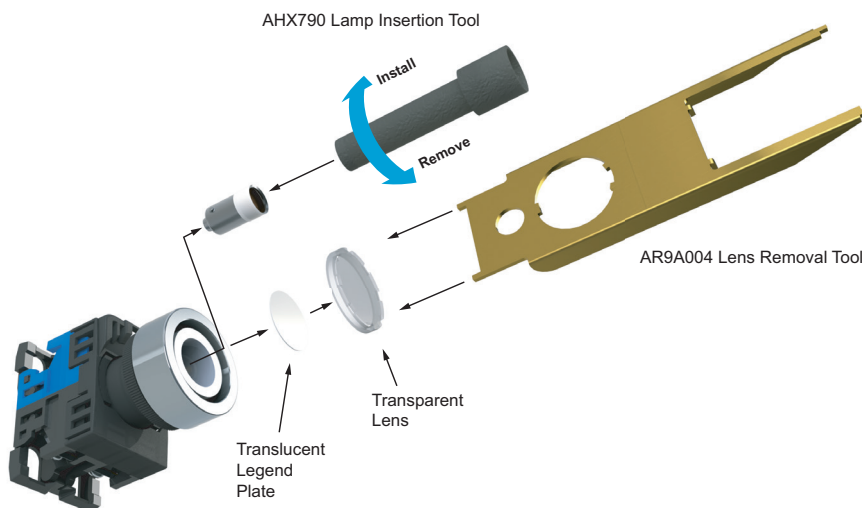



Command Series 22mm Emergency Stop Pushbuttons Specifications

22mm Emergency Stop Pushbuttons Specifications (Indoor Use)		
Series	AR22 - V0R, V7R, Q2R, V0L	AR22 VQR, VPR, VQL
Rated thermal current (contact block)	A600 / P600	B300 / R300
Mechanical durability	See durability table	250,000 operations
Electrical durability	500,000 operations at 220 VAC 6A 1 million operations at 220 VAC 3A	100,000 operations
Operating frequency	1200 operations/hour (On-load factor: 40%)	900 operations/hour (On-load factor: 40%)
Operating force (Avg)	30-45N	Push to Lock: 40N, Pull to reset: 33N Turn to reset: 0.3 N·m
Positive opening operation	All functions incorporating a N.C. contact are positive-opening operation.	
Dielectric strength	2,500VAC, 1 minute (w/o transformer 2000VAC)	2000 VAC 1 min
Insulation resistance	100MΩ or more (500VDC megger)	
Rated impulse dielectric strength	6kV	2.5 kV
Conditional short-circuit current	1000A	
Short-circuit protective device	Fuse 15A (recommended, not supplied)	Fuse 10A
Pollution degree	3	
Vibration	Resonance: 10 to 55Hz, double amplitude 0.1 mm* Constant: 16.7 Hz, double amplitude 3mm	10 to 55Hz, double amplitude 0.7 mm/s ²
Shock	Malfunction durability: 100 m/s ² ** Mechanical durability: 500 m/s ²	Malfunction: 150m/s ² Durability: 1000 m/s ²
Ambient temperature (no condensation or no icing)	Non-illuminated -20 to +70°C [-4 to +158°F] Illuminated -20 to -50°C [-4 to -58°F]	Non-illuminated -20 to +60°C [-4 to 140°F] Illuminated -20 to +50°C [-4 to 122°F]
Temperature ratings	Storage: -40 to +80°C [-40 to +176°F]	
Humidity	45 to 85% RH (within -5° to +40°C)	
Degree of protection	IP65	
Initial contact resistance	≤ 50mΩ	
Terminal markings	IEC 60445	
Connections	AWG 18 to 14; Stripping length: 8mm to 11mm Tightening torque: 0.8 to 1.0 N·m, 7.1 to 8.8 in·lb	Stranded wire: up to 1.25 mm ² , 24 to 16 AWG-CU Solid wire: up to ø1.2 mm, 24 to 16 AWG-CU Tightening torque: 1.0 to 1.5 N·m, 8.8 to 13.2 in·lb
Contacts operation	Self-cleaning types. Slow action. Positive opening.	
Operation frequency	1,200 cycle/hour (Application ratio 40%)	900 operations/hour (On-load factor: 40 %)
Utilization category/ contact ratings	AC-15: 24VAC at 6A, 110VAC at 6A DC-13: 24VDC at 4A, 110VDC at 1.3 A	DC-13: 24VDC at 1A DC-12 24VDC at 2A B300 120VAC Make 30A Break 3A 240VAC Make 15A Break 1.5 A
Rated insulation voltage	600 VAC/VDC***	250 VAC/VDC
Materials	Enclosure: Polyamide / Contacts: silver, nickel	
Standards	UL 508, CSA C22.2, No.14, TUV - EN60947-5-1	
Approvals	UL file E44592, CSA file LR20479	

* Emergency stop type: 10 to 500 Hz, double amplitude 0.7mm (acceleration 50m/s²), according to test condition of EN60947-5-5 (1998)

** Emergency stop type: 150 m/s²

***Illuminated type without transformer

To obtain the most current agency approval information, see the Agency Compliance & Certifications checklist section on the specific part number's web page.

Fuji Electric 22mm Pilot Devices Overview

Pushbuttons, Selectors, Pilot Lights, Joysticks, Buzzers

Fuji Electric AR22 pilot devices can be mounted on panels up to 6mm thick by securing the operator with a locking nut from behind the panel without needing any adjustment.

Easy mounting

Fuji AR22 pilot devices can be mounted on panels between 1 and 6mm thick and are mountable in panel cutouts of 22.3 or 25.5 mm. The button and lens can be mounted on a panel while the operator is engaged.

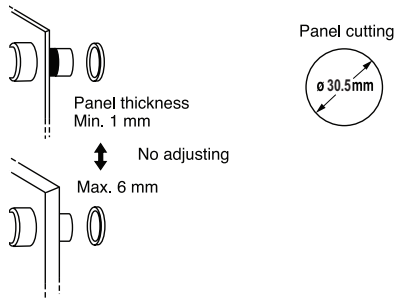

Pushbuttons



AR22F0R-01RZA

Illuminated Pushbuttons



AR22F0L-10E3YZA

Pilot Lights



DR22E3L-E3SZA

E-Stop Pushbuttons



AR22V0R-01R

Selector Switches



AR22PR-210BZA

Buzzers



DR22B8-EB

Wiring

These pilot devices can be wired in both vertical and lateral directions making wiring in narrow spaces easier. Contact block color coding makes wiring even easier.

1N.O. Blue, 1N.C. Red
Lamp terminal and transformer unit: black

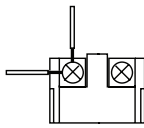

Quick contact block and transformer replacement

Fuji AR22 pilot devices have a snap-on mounting that makes replacing or adding a contact block and transformer unit easier.

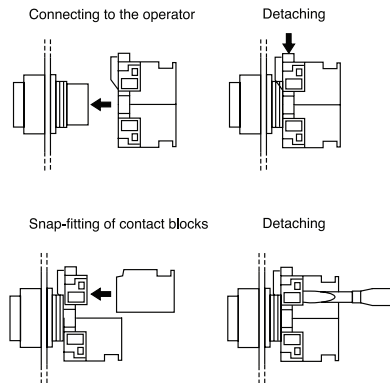

Safety

AR22 pilot devices include terminal covers for added safety and security. Emergency stop pushbuttons include a trigger action mechanism that prevents the contacts from moving until the button is pushed and locked.

Protection

AR22 pilot devices feature oil and dust-tight operator construction (IP65), except for buzzers DR22B5 (IP00), DR22B8 (IP54).

Short depth

Fuji AR22 pilot devices are designed to occupy less space than traditional 22mm devices.

