



# Command LED Illuminated 30mm Metal Selector Switches



**AR30PL-010E3RZC**



**AR30PL-311E3GZC**



**AR30PL-210L3SZC**

Command LED Illuminated 30mm Metal 2-Position Selector Switches						
Part Number	Color	Price	Drawing Link	Operation	Contacts	Lamp Voltage
<a href="#">AR30PL-010E3RZC</a>	Red	\$31.00	<a href="#">PDF</a>	2-pos spring return from right	N.O.	24V AC/DC
<a href="#">AR30PL-010E3GZC</a>	Green	\$31.00	<a href="#">PDF</a>			
<a href="#">AR30PL-010E3WZC</a>	White	\$31.00	<a href="#">PDF</a>			
<a href="#">AR30PL-010E3SZC</a>	Blue	\$46.50	<a href="#">PDF</a>			
<a href="#">AR30PL-010E3YZC</a>	Yellow	\$31.00	<a href="#">PDF</a>			
<a href="#">AR30PL-010E3AZC</a>	Orange	\$31.00	<a href="#">PDF</a>	2-pos maintained	N.O.	24V AC/DC
<a href="#">AR30PL-210E3RZC</a>	Red	\$30.50	<a href="#">PDF</a>			
<a href="#">AR30PL-210E3GZC</a>	Green	\$30.50	<a href="#">PDF</a>			
<a href="#">AR30PL-210E3WZC</a>	White	\$30.50	<a href="#">PDF</a>			
<a href="#">AR30PL-210E3SZC</a>	Blue	\$45.00	<a href="#">PDF</a>			
<a href="#">AR30PL-210E3YZC</a>	Yellow	\$30.50	<a href="#">PDF</a>	2-pos spring return from right	N.O.	115-127 VAC
<a href="#">AR30PL-210E3AZC</a>	Orange	\$30.50	<a href="#">PDF</a>			
<a href="#">AR30PL-010L3RZC</a>	Red	\$39.00	<a href="#">PDF</a>			
<a href="#">AR30PL-010L3GZC</a>	Green	\$39.00	<a href="#">PDF</a>			
<a href="#">AR30PL-010L3WZC</a>	White	\$39.00	<a href="#">PDF</a>			
<a href="#">AR30PL-010L3SZC</a>	Blue	\$53.00	<a href="#">PDF</a>	2-pos maintained	N.O.	115-127 VAC
<a href="#">AR30PL-010L3YZC</a>	Yellow	\$39.00	<a href="#">PDF</a>			
<a href="#">AR30PL-010L3AZC</a>	Orange	\$39.00	<a href="#">PDF</a>			
<a href="#">AR30PL-210L3RZC</a>	Red	\$41.50	<a href="#">PDF</a>			
<a href="#">AR30PL-210L3GZC</a>	Green	\$41.50	<a href="#">PDF</a>			
<a href="#">AR30PL-210L3WZC</a>	White	\$41.50	<a href="#">PDF</a>	2-pos maintained	N.O.	115-127 VAC
<a href="#">AR30PL-210L3SZC</a>	Blue	\$55.00	<a href="#">PDF</a>			
<a href="#">AR30PL-210L3YZC</a>	Yellow	\$41.50	<a href="#">PDF</a>			
<a href="#">AR30PL-210L3AZC</a>	Orange	\$41.50	<a href="#">PDF</a>			

Contact Block Mounting Position		Operator 2-Position	
Top	Bottom		
N.O.	-----	O	X
X = On, O = Off			

Note: Selector switches with transformers do not allow contact blocks in the bottom positions.

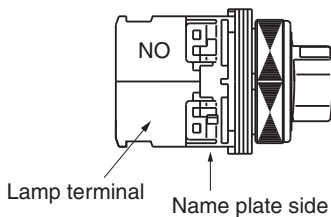

2-pos Contact Positions

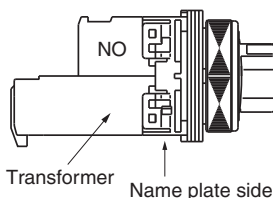

2-pos Contact Positions (with transformer)

# Command LED Illuminated 30mm Metal Selector Switches

Command LED Illuminated 30mm Metal 3-Position Selector Switches						
Part Number	Color	Price	Drawing Link	Operation	Contacts	Lamp Voltage
<a href="#">AR30PL-311E3RZC</a>	Red	\$35.50	<a href="#">PDF</a>	3-position maintained	1 N.O. + 1 N.C.	24V AC/DC
<a href="#">AR30PL-311E3GZC</a>	Green	\$35.50	<a href="#">PDF</a>			
<a href="#">AR30PL-311E3WZC</a>	White	\$35.50	<a href="#">PDF</a>			
<a href="#">AR30PL-311E3SZC</a>	Blue	\$49.00	<a href="#">PDF</a>			
<a href="#">AR30PL-311E3YZC</a>	Yellow	\$35.50	<a href="#">PDF</a>			
<a href="#">AR30PL-311E3AZC</a>	Orange	\$35.50	<a href="#">PDF</a>			
<a href="#">AR30PL-611E3RZC</a>	Red	\$37.00	<a href="#">PDF</a>	3-position spring return to center	1 N.O. + 1 N.C.	24V AC/DC
<a href="#">AR30PL-611E3GZC</a>	Green	\$37.00	<a href="#">PDF</a>			
<a href="#">AR30PL-611E3WZC</a>	White	\$37.00	<a href="#">PDF</a>			
<a href="#">AR30PL-611E3SZC</a>	Blue	\$51.00	<a href="#">PDF</a>			
<a href="#">AR30PL-611E3YZC</a>	Yellow	\$37.00	<a href="#">PDF</a>			
<a href="#">AR30PL-611E3AZC</a>	Orange	\$37.00	<a href="#">PDF</a>			
<a href="#">AR30PL-311L3RZC</a>	Red	\$43.00	<a href="#">PDF</a>	3-position maintained	1 N.O. + 1 N.C.	115-127 VAC
<a href="#">AR30PL-311L3GZC</a>	Green	\$43.00	<a href="#">PDF</a>			
<a href="#">AR30PL-311L3WZC</a>	White	\$43.00	<a href="#">PDF</a>			
<a href="#">AR30PL-311L3SZC</a>	Blue	\$57.00	<a href="#">PDF</a>			
<a href="#">AR30PL-311L3YZC</a>	Yellow	\$43.00	<a href="#">PDF</a>			
<a href="#">AR30PL-311L3AZC</a>	Orange	\$43.00	<a href="#">PDF</a>			
<a href="#">AR30PL-611L3RZC</a>	Red	\$45.00	<a href="#">PDF</a>	3-position spring return to center	1 N.O. + 1 N.C.	115-127 VAC
<a href="#">AR30PL-611L3GZC</a>	Green	\$45.00	<a href="#">PDF</a>			
<a href="#">AR30PL-611L3WZC</a>	White	\$45.00	<a href="#">PDF</a>			
<a href="#">AR30PL-611L3SZC</a>	Blue	\$59.00	<a href="#">PDF</a>			
<a href="#">AR30PL-611L3YZC</a>	Yellow	\$45.00	<a href="#">PDF</a>			
<a href="#">AR30PL-611L3AZC</a>	Orange	\$45.00	<a href="#">PDF</a>			

Contact Block Mounting Position		Operator 3-Position		
Top	Bottom			
N.O.	-----	X	O	O
N.C.*	-----	O	O	X
-----	N.C.**	O	O	X

X = On, O = Off

\*Models with transformers

\*\*Models without transformers

Note: Selector switches with transformers do not allow contact blocks in the bottom position.

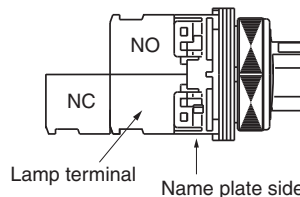

3-pos Contact Positions

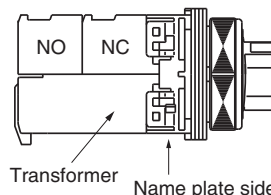

3-pos Contact Positions (with transformer)

# Fuji Electric 30mm Pilot Devices Overview

## Pushbuttons, Selectors, Pilot Lights, Joysticks, Buzzer

Fuji Electric AR30 pilot devices can be mounted on panels up to 6mm thick by securing the operator with a locking nut from behind the panel without needing any adjustment.

### Easy mounting

Fuji Electric AR30 pilot devices can be mounted on panels between 1 and 6mm thick and are mountable in panel cutouts of 30.5 mm.

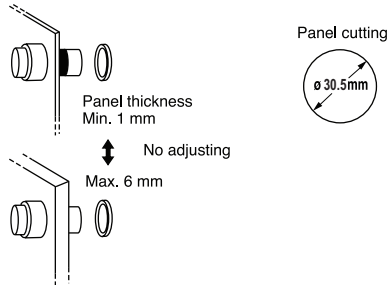

### Wiring

These pilot devices can be wired in both vertical and lateral directions making wiring in narrow spaces easier. Contact block color coding makes wiring even easier.

1N.O. Blue, 1N.C. Red  
Lamp terminal and transformer unit: black

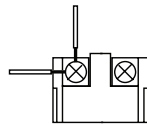

### Quick contact block and transformer replacement

Fuji AR30 pilot devices have a snap-on mounting that makes replacing or adding a contact block and transformer unit easier.

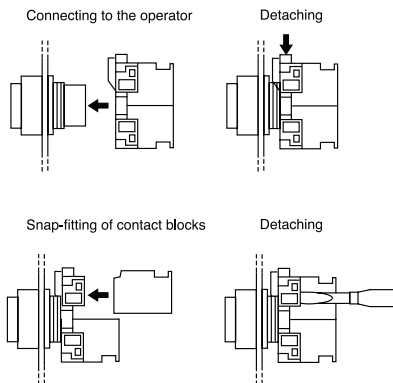

### Pushbuttons



AR30F0R-01RZC

### Illuminated Pushbuttons



AR30E0L-10L3GZC

### Pilot Lights



DR30D0L-L9SZC

### E-Stop Pushbuttons



AR30Q2R-01RZC

### Selector Switches



AR30PR-210BZC

### Buzzers



DR30B5-EBZC

### Short depth

Fuji AR30 pilot devices are designed to occupy less space than traditional 30mm devices.

### Safety

AR30 pilot devices include terminal covers for added safety and security. Emergency stop pushbuttons include a trigger action mechanism that prevents the contacts from moving until the button is pushed and locked

### Protection

AR30 pilot devices feature oil- and dust-tight operator construction (IP65), except for buzzers DR30B5 (IP00).



TO OBTAIN THE MOST CURRENT AGENCY APPROVAL INFORMATION, SEE THE AGENCY COMPLIANCE & CERTIFICATIONS CHECKLIST SECTION ON THE SPECIFIC PART NUMBER'S WEB PAGE.



# Accessories for 30mm Command Series Pilot Devices



**AHX177-00**



**AHX177-0B**

Legend Plates for Command Series 30mm Devices					
Part Number	Price	Drawing Link	Legend	Material	Color
<a href="#">AHX177-00</a>	\$2.25	<a href="#">PDF</a>	blank	brass	Silver field, silver background
<a href="#">AHX177-0B</a>	\$2.25	<a href="#">PDF</a>	OFF	brass	Silver field, silver background, black text
<a href="#">AHX177-0A</a>	\$2.25	<a href="#">PDF</a>	ON	brass	
<a href="#">AHX177-0C</a>	\$2.25	<a href="#">PDF</a>	START	brass	
<a href="#">AHX177-0D</a>	\$2.25	<a href="#">PDF</a>	STOP	brass	
<a href="#">AHX177-2A</a>	\$2.25	<a href="#">PDF</a>	OFF-ON	brass	
<a href="#">AHX720-5A</a>	\$8.75	<a href="#">PDF</a>	EMERGENCY STOP	aluminum	Yellow field, yellow background, black text



**AHX720-5A**

Tools and Lock Nut for Use with Command Series 30mm Pilot Devices		
Part Number	Price	Description
<a href="#">AR9A006</a>	\$31.50	Fuji Electric mounting wrench. For use with AR22, AR30, DR22 and DR30 series pushbuttons, switches, indicators and buzzers.
<a href="#">AR9R055</a>	\$16.50	Fuji Electric guard ring, replacement, 30mm, metal. Package of 5. For use with AR30G2L series pushbuttons.
<a href="#">AHX082</a>	\$1.00	Fuji Electric key washer, replacement, 30mm, metal. Package of 5. For use with AR30 and DR30 series pushbuttons, switches, indicators and buzzers.
<a href="#">AHX088</a>	\$5.25	Fuji Electric lock nut, replacement, 30mm, metal. Package of 5. For use with AR30F0R, DR30D0L, E0L, E0R and Q7L series pushbuttons, switches and indicators.
<a href="#">AHX093</a>	\$5.25	Fuji Electric lock nut, replacement, 30mm, metal. Package of 5. For use with AR30M0R, A_N, JR, PL, PR, Q2R and WR series pushbuttons, switches and indicators.
<a href="#">AHX282</a>	\$1.00	Fuji Electric sealing/spacer washer, replacement, 30mm. Package of 5. For use with AR30 and DR30 series pushbuttons, switches, indicators and buzzers.



**AR9R055**



**AHX082**



**AHX088**



**AHX282**



# Accessories for 30mm Command Series Pilot Devices

## Contact Blocks

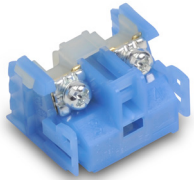

**AR9B290**

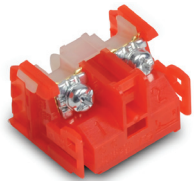

**AR9B291**

Contact Blocks for Command Series 30mm Pushbuttons					
Part Number	Qty	Price	Drawing Link	Color	Contacts
<a href="#"><u>AR9B290</u></a>	1	\$6.25	<a href="#"><u>PDF</u></a>	Blue	N.O.
<a href="#"><u>AR9B291</u></a>	1	\$6.25	<a href="#"><u>PDF</u></a>	Red	N.C.

Minimum current requirement AC/DC is 5mA

### Terminal Layout

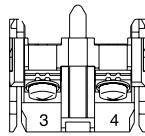

Terminal No.3, 4

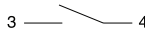

**AR9B290**

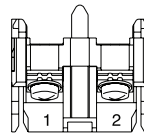

Terminal No.1, 2

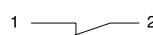

**AR9B291**

Max 6 contacts for non-illuminated momentary devices. Max 4 for alternate action non-illuminated devices.  
 Max 5 contacts for illuminated momentary devices. Max 3 for alternate action illuminated devices.  
 \*Exceeding the maximum number of contacts could affect the mechanical durability of the operators.



# Command Series 30mm Pilot Devices Specifications

## Assembly information

These pushbuttons are supplied with the appropriate contact blocks, unless otherwise indicated. Use these drawings as a guide to make sure there is adequate clearance behind the panel. Insert the switch unit in the panel hole at the back of the panel and secure it with a locking nut at the panel front.

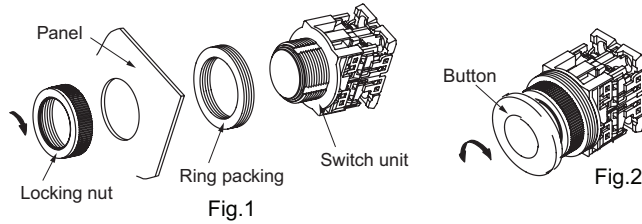

Example mounting diagram for AR30M0R

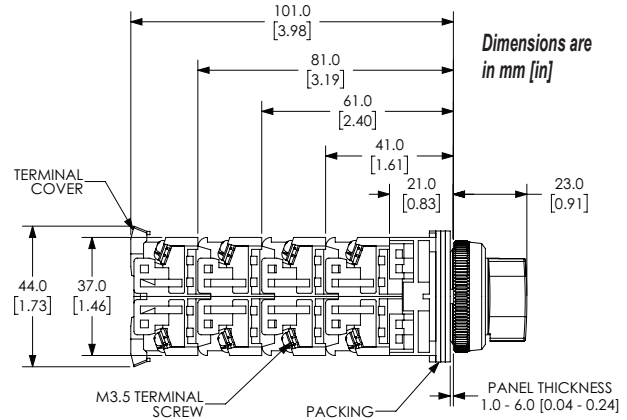

NOTE: Contact blocks can be arranged up to four deep by two wide.

## Panel holes

For safe operation, use these mounting hole drawings to ensure that there is adequate space between switches.

Note: Location hole 4.8mm x 33mm is for use with a key washer or legend plate. If key-washer or legend plate are not used, this location hole is not needed. ADC does not currently carry an appropriate 4.8mm punch if the hole is needed.

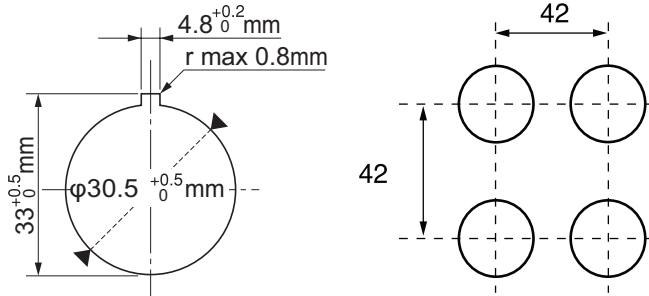

## Typical Wiring

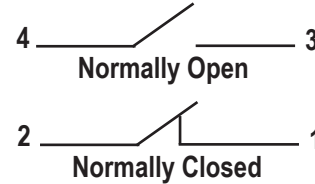

Mechanical Durability		
		Operations
<b>Pushbutton switch</b> <b>Illuminated pushbutton switch</b> <b>E-stop pushbutton switch</b> <b>E-stop illuminated pushbutton</b>	Momentary action	5 million
	Alternate action	1 million
	Push-lock, turn-reset	100,000
	Push-lock, pull-reset	30,000
<b>Selector switch</b>	Maintained 1, 2, 3, 4-contact	1 million
	Maintained 5, 6-contact	500,000
	Spring return, spring/manual return	200,000
<b>Illuminated selector switch</b>	Maintained	
	Without transformer 1, 2, 3-contact	1 million
	4-contact	500,000
	With transformer 1, 2-contact	1 million
	3-contact	500,000
Spring return, spring/manual return	200,000	

Note: Key insertion/removal durability for selector switch key types  
Key type 10,000



# Command Series 30mm Pilot Devices Specifications

Specifications (Indoor Use)			
	Pushbuttons Selector switches	Joysticks	Pilot Lights
Rated thermal current (contact block)	A600 P600	—	—
Mechanical durability	See mechanical durability table	250,000 operations	—
Electrical durability	500,000 operations at 220VAC 6A 1,000,000 operations at 220VAC 3A	100,000 operations at 220VAC 1A (res. load)	—
Operating frequency	1200 operations/hour (on-load factor: 40%)		—
Operating force (Avg)	9N – Pushbuttons 0.15 - 0.1 N·m – Selector switches	Less than 100N	
Positive opening operation	All functions incorporating an N.C. contact are positive-opening operation.		
Dielectric strength	2,000VAC, 1 minute*** 2,500VAC, 1 minute****	2,000VAC, 1 minute	
Insulation resistance	100MΩ or more (500VDC megger)		
Rated impulse dielectric strength	6kV	-	6kV
Conditional short-circuit current	1000A		—
Short-circuit protective device	Fuse 15A	Fuse 1A	—
Pollution degree	3		
Vibration	Resonance: 10 to 55 Hz, double amplitude 0.1mm*, Constant: 16.7 Hz, double amplitude 3mm		
Shock	Malfunction: 100m/s <sup>2</sup> ** Mechanical: 500m/s <sup>2</sup>		Mechanical: 500m/s <sup>2</sup>
Ambient temperature (no condensation or no icing)	-20 to 70°C [-4 to 158°F]	-5 to 60°C [23 to 140°F]	-20 to 50°C [-4 to 122°F]
Temperature ratings	Storage: -40 to 80°C [-40 to 176°F]		
Humidity	45 to 85% RH [within -5°C to 40°C]		
Degree of protection	IEC IP65		
Initial contact resistance	≥ 50mΩ	—	—
Terminal markings	IEC 60445	—	—
Connections	14 to 18 AWG; Stripping length: 5 to 11mm Tightening torque: 0.8 to 1.0 N·m, 7.1 to 8.8 in·lb		
Contacts operation	Self-cleaning types. Slow action. Positive opening.		
Operation frequency	1,200 cycle/hour (Application ratio 40%)	—	—
Utilization category/ contact ratings	AC-15: 24VAC at 6A, 110VAC at 6A DC-13: 24VDC at 4A, 110VDC at 1.3 A	AC-1: 110VAC at 0.3 A DC-13: 24VDC at 0.7 A, 110VDC at 0.15 A	—
Rated insulation voltage	250V AC/DC*** 600V AC/DC	250V AC/DC	250V AC/DC*** 600VAC w/transformer
Materials	Enclosure: Polyamide, Contacts: Silver, nickel		
Standards	UL 508, CSA C22.2, No.14, TUV - EN60947-5-1		
Approvals	UL file E44592, CSA file LR20479		

\* Emergency stop type: 10 to 500 Hz, double amplitude 0.7mm (acceleration 50m/s<sup>2</sup>), according to test condition of EN60947-5-5 (1998)

\*\* Emergency stop type: 150 m/s<sup>2</sup>

\*\*\* Illuminated type without transformer

\*\*\*\* Illuminated type with transformer

To obtain the most current agency approval information, see the Agency Compliance & Certifications Checklist section on the specific part number's web page.