

PRODUCT SPECIFICATIONS

Lustertone® Classic Stainless Steel 25" x 22" x 4" Single Bowl Drop-in ADA Sink. Sink is manufactured from 18 gauge 304 Stainless Steel with a Lustrous Satin finish, Rear Center drain placement, and Bottom only pads.

| | |
|------------------------------|--|
| Installation Type: | Drop-in |
| Material: | 304 Stainless Steel |
| Finish: | Lustrous Satin |
| Gauge: | 18 |
| Sound Deadening: | Bottom only pads |
| Number of Bowls: | 1 |
| Sink Dimensions: | 25" x 22" x 4" |
| Bowl 1 Dimensions: | 21" x 15-3/4" x 3-5/8" |
| Drain Size: | 3-1/2" (89mm) |
| Drain Location: | Rear Center |
| Minimum Cabinet Size: | 30" |
| Mounting Hardware: | Part # 64090012 included for countertops up to 3/4" (19mm) thick |
| Template Included: | No |
| Cutout Template #: | 1000001188 |

Template is available for download at [elkay.com](#). CAD software will be required to open the template.

Cutout Dimensions for Drop-in Installation:
24-3/8" x 21-3/8" (619mm x 543mm) with 1-1/2" (38mm) corner radius

Hole Drilling Configurations:

1-1/2" (38mm) Diameter Faucet Holes on 4" (102mm) Centers

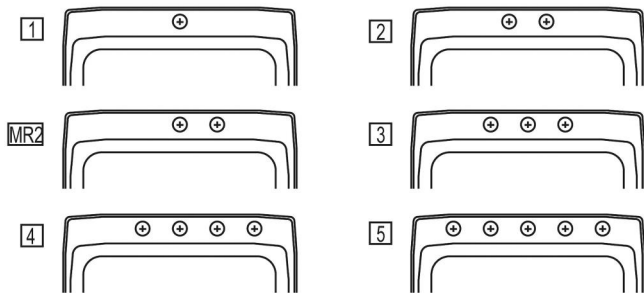

A Century of Tradition and Quality. For more than 100 years, Elkay has been making innovative products and providing exceptional customer care. We take pride in offering plumbing products that make life easier, inspire change and leave the world a better place.



Product Compliance: ADA & ICC A117.1
ASME A112.19.3/CSA B45.4



Sinks are listed by IAPMO® as meeting the applicable requirements of the Uniform Plumbing Code®, International Plumbing Code®, and National Plumbing Code of Canada.



Complies with ADA & ICC A117.1 accessibility requirements when installed according to the requirements outlined in these standards.

[Clean and Care Manual \(PDF\)](#)
[Installation Instructions \(PDF\) - 1000005236](#)
[Warranty \(PDF\)](#)

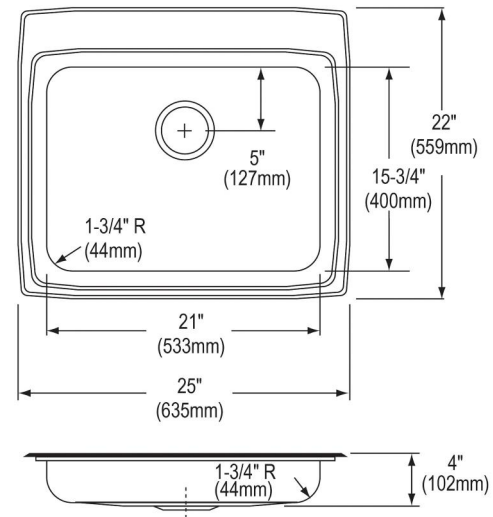



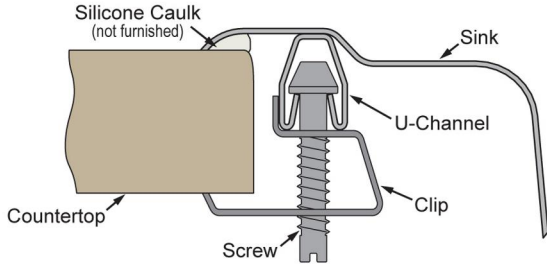

PART: _____ QTY: _____
PROJECT: _____
CONTACT: _____
DATE: _____
NOTES: _____
APPROVAL: _____

In keeping with our policy of continuing product improvement, Elkay reserves the right to change product specifications without notice. Please visit [elkay.com](#) for the most current version of Elkay product specification sheets. This specification describes an Elkay product with design, quality, and functional benefits to the user. When making a comparison of other producers' offerings, be certain these features are not overlooked. Latest version of the spec sheet available: https://www.elkayfiles.com/spec-sheets/LRAD252240_spec.pdf

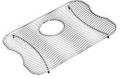
Installation Profile:



| Optional Accessories | | |
|------------------------------|---|---|
| LKWOBG2115SS | Stainless Steel 20" x 14-3/4" x 1" Bottom Grid Spec Sheet (PDF) |  |
| CB1516 | Hardwood 15" x 16-3/4" x 3/4" Cutting Board Spec Sheet (PDF) |  |
| LK99 | Deluxe 3-1/2" Drain Type 304 Stainless Steel Body Strainer Basket Rubber Seal and Tailpiece Spec Sheet (PDF) |  |
| LKWERBSS | Stainless Steel 15-3/8" x 12-3/8" x 5-7/16" Rinsing Basket Spec Sheet (PDF) |  |

In keeping with our policy of continuing product improvement, Elkay reserves the right to change product specifications without notice. Please visit elkay.com for the most current version of Elkay product specification sheets. This specification describes an Elkay product with design, quality, and functional benefits to the user. When making a comparison of other producers' offerings, be certain these features are not overlooked. Latest version of the spec sheet available: https://www.elkayfiles.com/spec-sheets/LRAD252240_spec.pdf