

PRODUCT SPECIFICATIONS

Foodservice 8" Centerset Wall Mount Faucet with 10" Arc Tube Spout 4" Wristblade Handles 1/2" Offset Inlets. Faucet has a flow rate of 1.5 GPM, and is made of Chrome-plated Brass material, with a Quarter Turn Ceramic Disc valve. Faucet requires 2 faucet holes.

| | |
|--------------------------------|---|
| Mounting Type: | Wall Mount |
| Special Features: | 1/2" Adjustable Inlets Low Flow Solid Brass Construction Spout Swing Restriction Pin |
| Finish: | Chrome (CR) |
| Handle Type: | 4" Wristblade Handle |
| Deck Clearance: | 4-3/16" |
| Spout Reach: | 10" |
| Spout Height: | 6-13/16" |
| Hole Drillings: | 2 |
| Material: | Chrome-plated Brass |
| Valve Type: | Quarter Turn Ceramic Disc |
| Valve Connection: | 1/2" NPT Female |
| Flow Rate: | 1.5 GPM |
| Faucet Hole Size (min): | 1-1/2" |
| Faucet Hole Spread: | 8 |
| Spout Type: | Arc Tube |



A Century of Tradition and Quality.
For more than 100 years, Elkay has been making innovative products and providing exceptional customer care. We take pride in offering plumbing products that make life easier, inspire change and leave the world a better place.

Product Compliance: ADA & ICC A117.1
ASME A112.18.1/CSA B125.1
CEC
NSF 372 (lead free)
NSF 61 (Q≤1)



Chrome (CR)



Complies with ADA & ICC A117.1 accessibility requirements when installed according to the requirements outlined in these standards.

[Clean and Care Manual \(PDF\)](#)
[Installation Instructions \(PDF\) - A55483](#)
[Warranty \(PDF\)](#)

PART: _____ QTY: _____
PROJECT: _____
CONTACT: _____
DATE: _____
NOTES: _____
APPROVAL: _____

In keeping with our policy of continuing product improvement, Elkay reserves the right to change product specifications without notice. Please visit elkay.com for the most current version of Elkay product specification sheets. This specification describes an Elkay product with design, quality, and functional benefits to the user. When making a comparison of other producers' offerings, be certain these features are not overlooked.

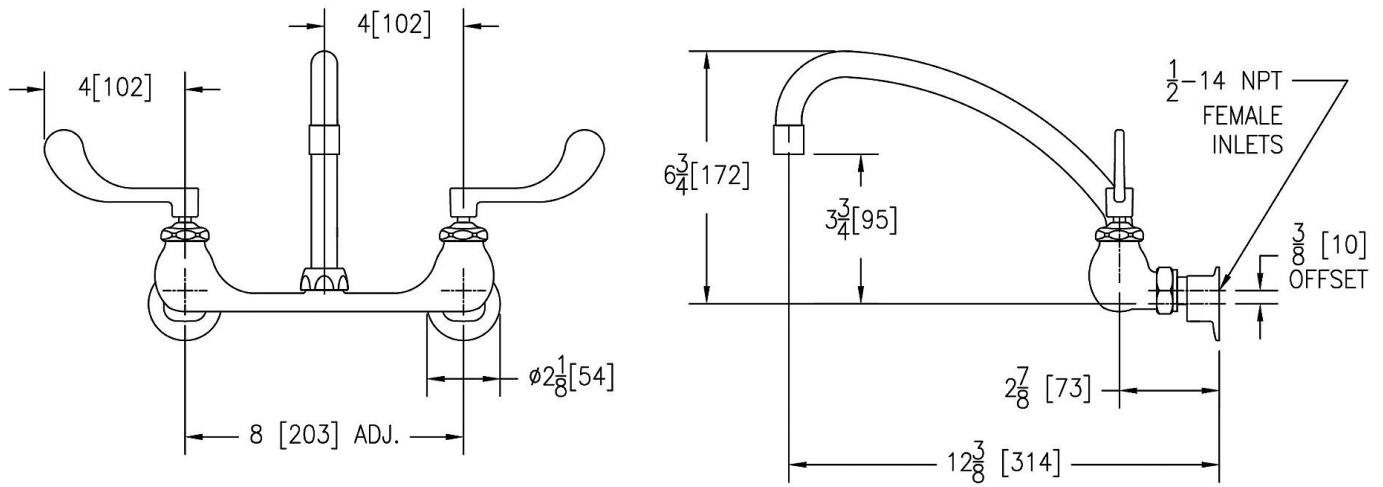

In keeping with our policy of continuing product improvement, Elkay reserves the right to change product specifications without notice. Please visit elkay.com for the most current version of Elkay product specification sheets. This specification describes an Elkay product with design, quality, and functional benefits to the user. When making a comparison of other producers' offerings, be certain these features are not overlooked.