

**PRODUCT SPECIFICATIONS**

Stainless Steel 60" x 23" x 26" Wall Hung Double Station Surgeon Scrub Sink Kit w/Soap and Water Knee Activation. Sink is manufactured from 16 gauge 304 Stainless Steel with a Buffed Satin finish, Rear Center drain placement.

<b>Material:</b>	304 Stainless Steel
<b>Finish:</b>	Buffed Satin
<b>Gauge:</b>	16
<b>Number of Bowls:</b>	2
<b>Sink Dimensions:</b>	60" x 23" x 26"
<b>Bowl 1 Dimensions:</b>	26" x 16-1/4" x 11"
<b>Bowl 2 Dimensions:</b>	26" x 16-1/4" x 11"
<b>Drain Size:</b>	3-1/2" (89mm)
<b>Drain Location:</b>	Rear Center
<b>Mounting Hardware:</b>	Yes



**Included with Product:** EWSF26026 sink, two LK394A spouts, two LK18B drains

A Century of Tradition and Quality.  
For more than 100 years, Elkay has been making innovative products and providing exceptional customer care. We take pride in offering plumbing products that make life easier, inspire change and leave the world a better place.

**Product Compliance:** ASME A112.19.3/CSA B45.4  
Faucet: ASME A112.18.1/CSA B125.1  
Accessory: ASME A112.18.2/CSA B125.2



Sinks are listed by IAPMO<sup>®</sup> as meeting the applicable requirements of the Uniform Plumbing Code<sup>®</sup>, International Plumbing Code<sup>®</sup>, and National Plumbing Code of Canada.

[Clean and Care Manual \(PDF\)](#)  
[Installation Instructions \(PDF\) - 200000714](#)  
[Installation Instructions \(PDF\) - 0000001434](#)  
[Warranty \(PDF\)](#)

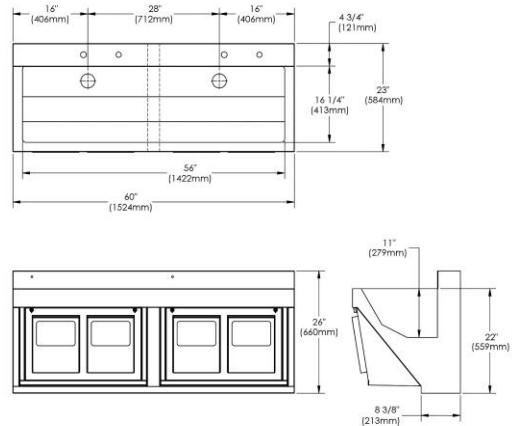

PART: \_\_\_\_\_ QTY: \_\_\_\_\_  
PROJECT: \_\_\_\_\_  
CONTACT: \_\_\_\_\_  
DATE: \_\_\_\_\_  
NOTES: \_\_\_\_\_  
APPROVAL: \_\_\_\_\_

*In keeping with our policy of continuing product improvement, Elkay reserves the right to change product specifications without notice. Please visit [elkay.com](http://elkay.com) for the most current version of Elkay product specification sheets. This specification describes an Elkay product with design, quality, and functional benefits to the user. When making a comparison of other producers' offerings, be certain these features are not overlooked.*

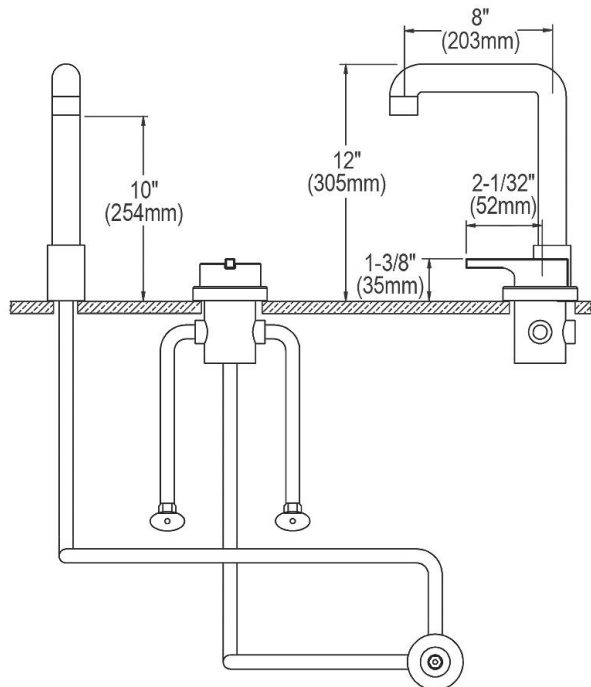
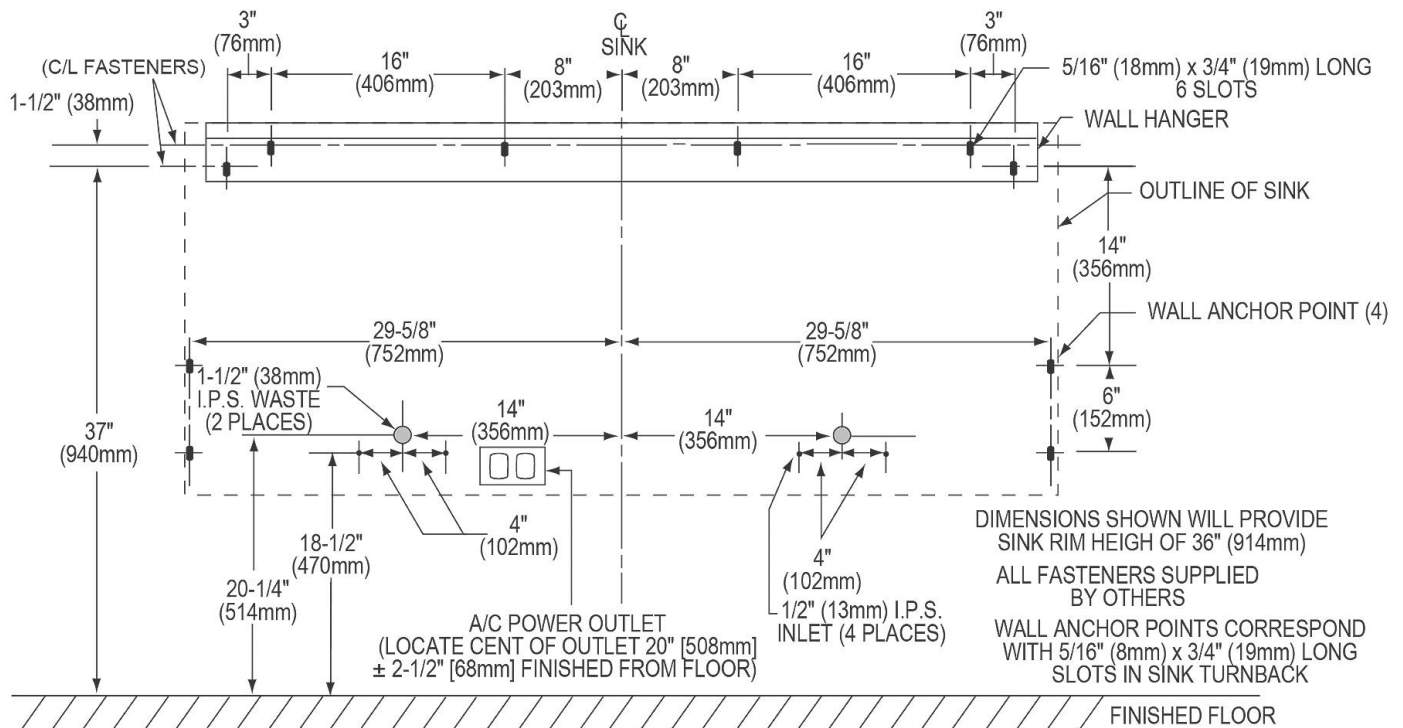

FAUCET AND TEMPERATURE HANDLE

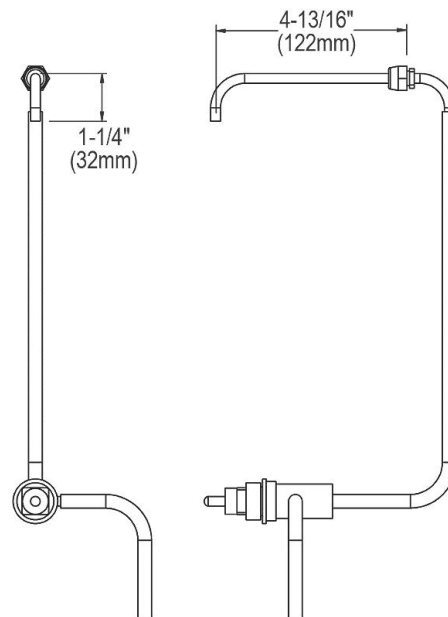

SOAP SPOUT

In keeping with our policy of continuing product improvement, Elkay reserves the right to change product specifications without notice. Please visit [elkay.com](http://elkay.com) for the most current version of Elkay product specification sheets. This specification describes an Elkay product with design, quality, and functional benefits to the user. When making a comparison of other producers' offerings, be certain these features are not overlooked.