

PRODUCT SPECIFICATIONS

Stainless Steel 18" x 17-1/16" x 5-9/16" Wall Hung Lavatory Sink.
Sink is manufactured from 18 gauge 304 Stainless Steel with a
Buffed Satin finish, Rear Center drain placement.

Material:	304 Stainless Steel
Finish:	Buffed Satin
Gauge:	18
Number of Bowls:	1
Sink Dimensions:	18" x 17-1/16" x 15-3/8"
Bowl 1 Dimensions:	13-5/8" x 10-1/8" x 5-13/16"
Drainboard Location:	No drainboard
Backsplash Height:	5.6875
Drain Size:	1-1/2" (38mm)
Drain Location:	Rear Center



Hole Drilling Configurations:

1-1/4" (32mm) Diameter Faucet Holes For CS3 Hole Model
1-1/2" (38mm) Diameter Faucet Holes For 3 Hole Model

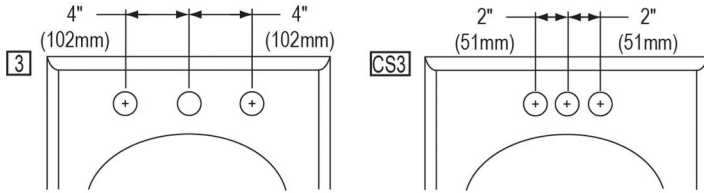

A Century of Tradition and Quality.

For more than 100 years, Elkay has been making innovative products and providing exceptional customer care. We take pride in offering plumbing products that make life easier, inspire change and leave the world a better place.



Product Compliance: ADA & ICC A117.1
NSF 2



Sinks are listed by IAPMO[®] as meeting the applicable requirements of the Uniform Plumbing Code[®], International Plumbing Code[®], and National Plumbing Code of Canada.

Complies with ADA & ICC A117.1 accessibility requirements when installed according to the requirements outlined in these standards.

[Clean and Care Manual \(PDF\)](#)
[Installation Instructions \(PDF\) - 2000000714](#)
[Warranty \(PDF\)](#)

PART: _____ QTY: _____
PROJECT: _____
CONTACT: _____
DATE: _____
NOTES: _____
APPROVAL: _____

In keeping with our policy of continuing product improvement, Elkay reserves the right to change product specifications without notice. Please visit elkay.com for the most current version of Elkay product specification sheets. This specification describes an Elkay product with design, quality, and functional benefits to the user. When making a comparison of other producers' offerings, be certain these features are not overlooked.

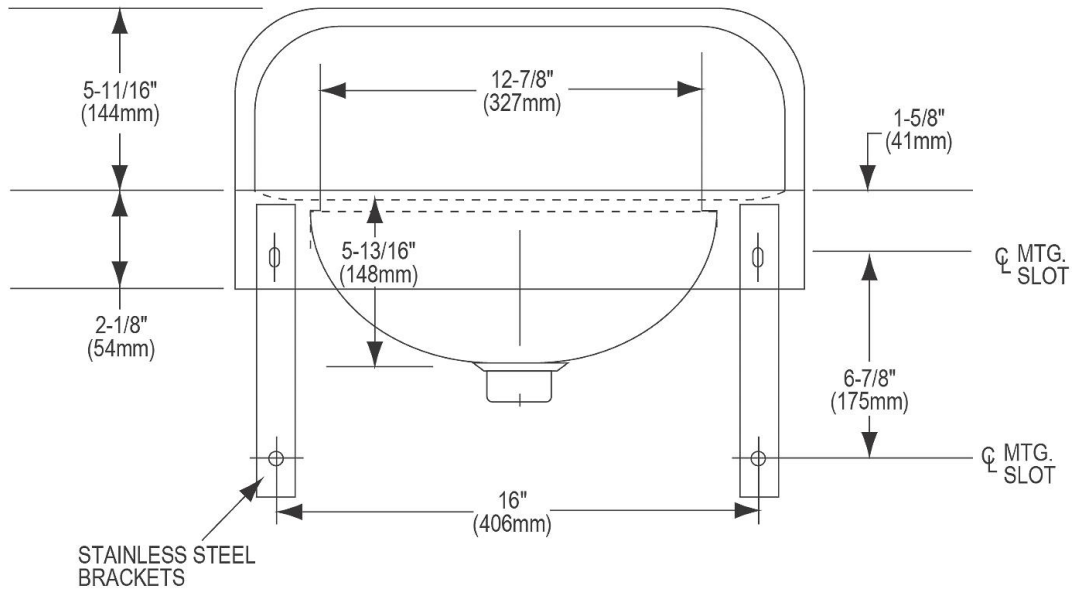

In keeping with our policy of continuing product improvement, Elkay reserves the right to change product specifications without notice. Please visit elkay.com for the most current version of Elkay product specification sheets. This specification describes an Elkay product with design, quality, and functional benefits to the user. When making a comparison of other producers' offerings, be certain these features are not overlooked.