

**PRODUCT SPECIFICATIONS**

Quartz Classic<sup>®</sup> 33" x 22" x 10" Offset 60/40 Double Bowl Drop-in Sink with Aqua Divide. Sink is molded with up to 80% natural quartz and high performance acrylic resins that are non-porous providing superior heat, scratch, fade and stain resistance. Naturally sound deadening and Rear Center drain placement.



<b>Installation Type:</b>	Drop-in
<b>Material:</b>	Quartz
<b>Special Features:</b>	Aqua Divide
<b>Finish:</b>	Black (BK), Dusk Gray (GY), Graphite (GT), Greystone (GS), Matte Black (MB), White (WH)
<b>Number of Bowls:</b>	2
<b>Sink Dimensions:</b>	33" x 22" x 10"
<b>Bowl 1 Dimensions:</b>	17-3/16" x 19-5/16" x 10"
<b>Bowl 2 Dimensions:</b>	13-1/8" x 16-5/8" x 10"
<b>Drain Size:</b>	3-1/2" (89mm)
<b>Drain Location:</b>	Rear Center
<b>Minimum Cabinet Size:</b>	36"
<b>Mounting Hardware:</b>	Part # 1000003441 included for countertops up to 1-3/4" (44mm) thick
<b>Template Included:</b>	No
<b>Cutout Template #:</b>	<a href="#">1000003470</a>

Template is available for download at [elkay.com](#). CAD software will be required to open the template.

**Cutout Dimensions for Drop-in Installation:**

32-3/8" x 21-3/8" (822mm x 543mm) with 3/16" (4.8mm) corner radius



**Installation Profile:**

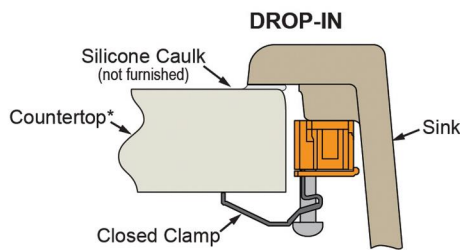

\*Maximum thickness for use of hold down system is 1-3/4" (44mm).

A Century of Tradition and Quality. For more than 100 years, Elkay has been making innovative products and providing exceptional customer care. We take pride in offering plumbing products that make life easier, inspire change and leave the world a better place.



**Product Compliance:** CSA B45.5/IAPMO Z124



Sinks are listed by IAPMO<sup>®</sup> as meeting the applicable requirements of the Uniform Plumbing Code<sup>®</sup>, International Plumbing Code<sup>®</sup>, and National Plumbing Code of Canada.

[Clean and Care Manual \(PDF\)](#)  
[Installation Instructions \(PDF\) - 1000005238](#)  
[Warranty \(PDF\)](#)

1-1/2" (38mm) Diameter Faucet Holes on 4" (102mm) Centers are Pre-Scored. Installer can punch up to 4 faucet holes.

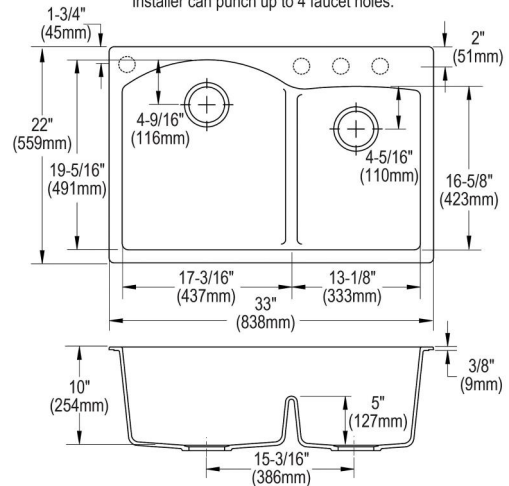

PART: \_\_\_\_\_ QTY: \_\_\_\_\_

PROJECT: \_\_\_\_\_







CONTACT: \_\_\_\_\_

DATE: \_\_\_\_\_

NOTES: \_\_\_\_\_

APPROVAL: \_\_\_\_\_

In keeping with our policy of continuing product improvement, Elkay reserves the right to change product specifications without notice. Please visit [elkay.com](#) for the most current version of Elkay product specification sheets. This specification describes an Elkay product with design, quality, and functional benefits to the user. When making a comparison of other producers' offerings, be certain these features are not overlooked. Latest version of the spec sheet available: [https://www.elkayfiles.com/spec-sheets/ELGH3322R\\_spec.pdf](https://www.elkayfiles.com/spec-sheets/ELGH3322R_spec.pdf)

Optional Accessories		
<a href="#">LK99</a>	Deluxe 3-1/2" Drain Type 304 Stainless Steel Body Strainer Basket Rubber Seal and Tailpiece <a href="#">Spec Sheet (PDF)</a>	
<a href="#">LKQD35</a>	Polymer 3-1/2" Disposer Flange with Removable Basket Strainer and Rubber Stopper <a href="#">Spec Sheet (PDF)</a>	
<a href="#">LKQS35</a>	Polymer 3-1/2" Drain Fitting with Removable Basket Strainer and Rubber Stopper <a href="#">Spec Sheet (PDF)</a>	
<a href="#">LKEC2031</a>	Explore™ Single Hole Kitchen Faucet with Pull-down Spray and Forward Only Lever Handle <a href="#">Spec Sheet (PDF)</a>	
<a href="#">LK6000</a>	Everyday Single Hole Deck Mount Kitchen Faucet with Pull-down Spray Forward Only Lever Handle <a href="#">Spec Sheet (PDF)</a>	
<a href="#">LKQD35</a>	Polymer 3-1/2" Disposer Flange with Removable Basket Strainer and Rubber Stopper <a href="#">Spec Sheet (PDF)</a>	
<a href="#">LKQS35</a>	Polymer 3-1/2" Drain Fitting with Removable Basket Strainer and Rubber Stopper <a href="#">Spec Sheet (PDF)</a>	

*In keeping with our policy of continuing product improvement, Elkay reserves the right to change product specifications without notice. Please visit [elkay.com](http://elkay.com) for the most current version of Elkay product specification sheets. This specification describes an Elkay product with design, quality, and functional benefits to the user. When making a comparison of other producers' offerings, be certain these features are not overlooked. Latest version of the spec sheet available: [https://www.elkayfiles.com/spec-sheets/ELGH3322R\\_spec.pdf](https://www.elkayfiles.com/spec-sheets/ELGH3322R_spec.pdf)*