

PRODUCT SPECIFICATIONS

Crosstown[®] 16 Gauge Stainless Steel 35-7/8" x 20-1/4" x 9" Double Bowl Tall Farmhouse Sink. Sink is handmade/fabricated from 16 gauge 304 Stainless Steel with a Polished Satin finish, Rear Center drain placement, and Full spray sides and bottom with Sides and Bottom pads.

| | |
|------------------------------|--|
| Installation Type: | Farmhouse |
| Material: | 304 Stainless Steel |
| Finish: | Polished Satin |
| Gauge: | 16 |
| Sound Deadening: | Full spray sides and bottom with Sides and Bottom pads |
| Number of Bowls: | 2 |
| Sink Dimensions: | 35-7/8" x 20-1/4" x 10" |
| Bowl 1 Dimensions: | 18-15/16" x 17" x 9" |
| Bowl 2 Dimensions: | 13-15/16" x 17" x 9" |
| Drain Size: | 3-1/2" (89mm) |
| Drain Location: | Rear Center |
| Minimum Cabinet Size: | 36" |
| Mounting Hardware: | Part # 54300008 included |
| Template Included: | No |

Special Note: Reserve Selection products are sold exclusively, in-store and online, through authorized wholesalers.

Installation Profile:

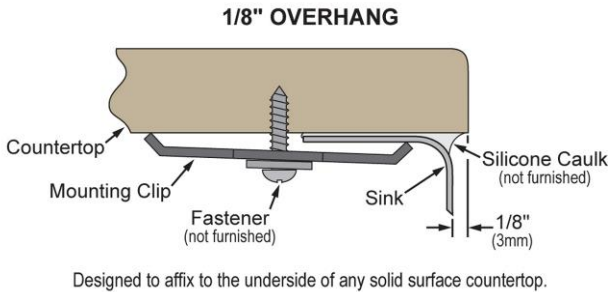

A Century of Tradition and Quality. For more than 100 years, Elkay has been making innovative products and providing exceptional customer care. We take pride in offering plumbing products that make life easier, inspire change and leave the world a better place.



Product Compliance: ASME A112.19.3/CSA B45.4



Sinks are listed by IAPMO[®] as meeting the applicable requirements of the Uniform Plumbing Code[®], International Plumbing Code[®], and National Plumbing Code of Canada.

[Clean and Care Manual \(PDF\)](#)
[Installation Instructions \(PDF\) - 100005325](#)
[Warranty \(PDF\)](#)

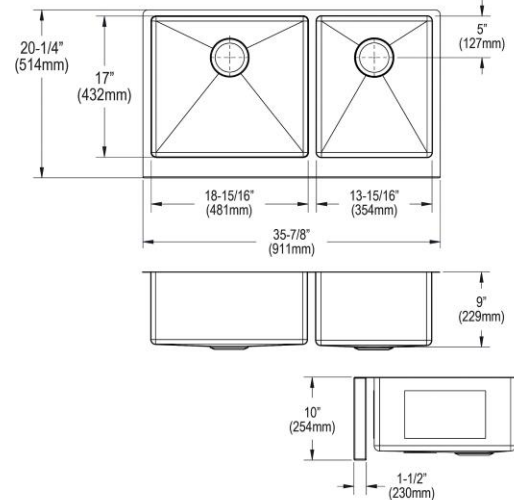

PART: _____ QTY: _____

PROJECT: _____





CONTACT: _____

DATE: _____

NOTES: _____

APPROVAL: _____

In keeping with our policy of continuing product improvement, Elkay reserves the right to change product specifications without notice. Please visit elkay.com for the most current version of Elkay product specification sheets. This specification describes an Elkay product with design, quality, and functional benefits to the user. When making a comparison of other producers' offerings, be certain these features are not overlooked. Latest version of the spec sheet available: https://www.elkayfiles.com/spec-sheets/EFRUFF23417_spec.pdf

| Optional Accessories | | |
|----------------------------|---|---|
| CTXFBG1316 | Crosstown® Stainless Steel 13-1/8" x 16-1/8" x 1-1/4" Bottom Grid Spec Sheet (PDF) |  |
| CTXFBG1816 | Crosstown® Stainless Steel 18-1/8" x 16-1/8" x 1-1/4" Bottom Grid Spec Sheet (PDF) |  |
| LK35 | 3-1/2" Drain Fitting Type 304 Stainless Steel Body Strainer Basket with 316 Stainless Steel Tailpiece Spec Sheet (PDF) |  |
| LK99 | Deluxe 3-1/2" Drain Type 304 Stainless Steel Body Strainer Basket Rubber Seal and Tailpiece Spec Sheet (PDF) |  |
| LKDD | 3-1/2" Drain Fitting Deep Strainer Basket Spec Sheet (PDF) |  |

In keeping with our policy of continuing product improvement, Elkay reserves the right to change product specifications without notice. Please visit elkay.com for the most current version of Elkay product specification sheets. This specification describes an Elkay product with design, quality, and functional benefits to the user. When making a comparison of other producers' offerings, be certain these features are not overlooked. Latest version of the spec sheet available: https://www.elkayfiles.com/spec-sheets/EFRUFF23417_spec.pdf