

PRODUCT SPECIFICATIONS

Crosstown® 18 Gauge Stainless Steel 31-1/2" x 18-1/2" x 9" 60/40 Double Bowl Undermount Sink & Faucet Kit with Drain. Sink is handmade/fabricated from 18 gauge 304 Stainless Steel with a Polished Satin finish, Rear Center drain placement, and Full spray sides and bottom with Sides and Bottom pads.

Installation Type:	Undermount
Material:	304 Stainless Steel
Finish:	Polished Satin
Gauge:	18
Sound Deadening:	Full spray sides and bottom with Sides and Bottom pads
Number of Bowls:	2
Sink Dimensions:	31-1/2" x 18-1/2" x 9"
Bowl 1 Dimensions:	17" x 17" x 9"
Bowl 2 Dimensions:	12" x 17" x 9"
Drain Size:	3-1/2" (89mm)
Drain Location:	Rear Center
Minimum Cabinet Size:	36"
Mounting Hardware:	Included
Template Included:	Yes
Cutout Template #:	1000001381

Template is available for download at elkay.com. CAD software will be required to open the template.

Installation Profile:

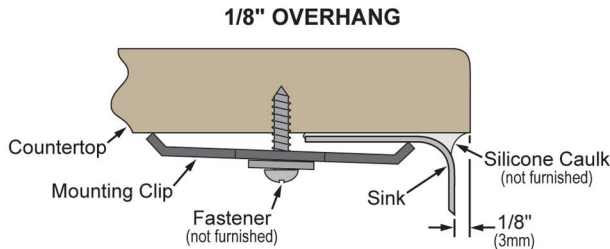

Designed to affix to the underside of any solid surface countertop.



Included with Product:

A Century of Tradition and Quality. For more than 100 years, Elkay has been making innovative products and providing exceptional customer care. We take pride in offering plumbing products that make life easier, inspire change and leave the world a better place.

2x deep strainer drain LKDD and faucet LKAV2061CR



Product Compliance:

- Faucet: ASME A112.19.3/CSA B45.4
ASME A112.18.1/CSA B125.1
NSF 61
NSF 372 (lead free)
- Accessory: ASME A112.18.2/CSA B125.2





Sinks are listed by IAPMO® as meeting the applicable requirements of the Uniform Plumbing Code®, International Plumbing Code®, and National Plumbing Code of Canada.





- [Clean and Care Manual \(PDF\)](#)
- [Clean and Care Manual \(PDF\)](#)
- [Installation Instructions \(PDF\) - 1000005239](#)
- [Installation Instructions \(PDF\) - 1000005235](#)
- [Warranty \(PDF\)](#)

PART: _____ QTY: _____
 PROJECT: _____
 CONTACT: _____
 DATE: _____
 NOTES: _____
 APPROVAL: _____

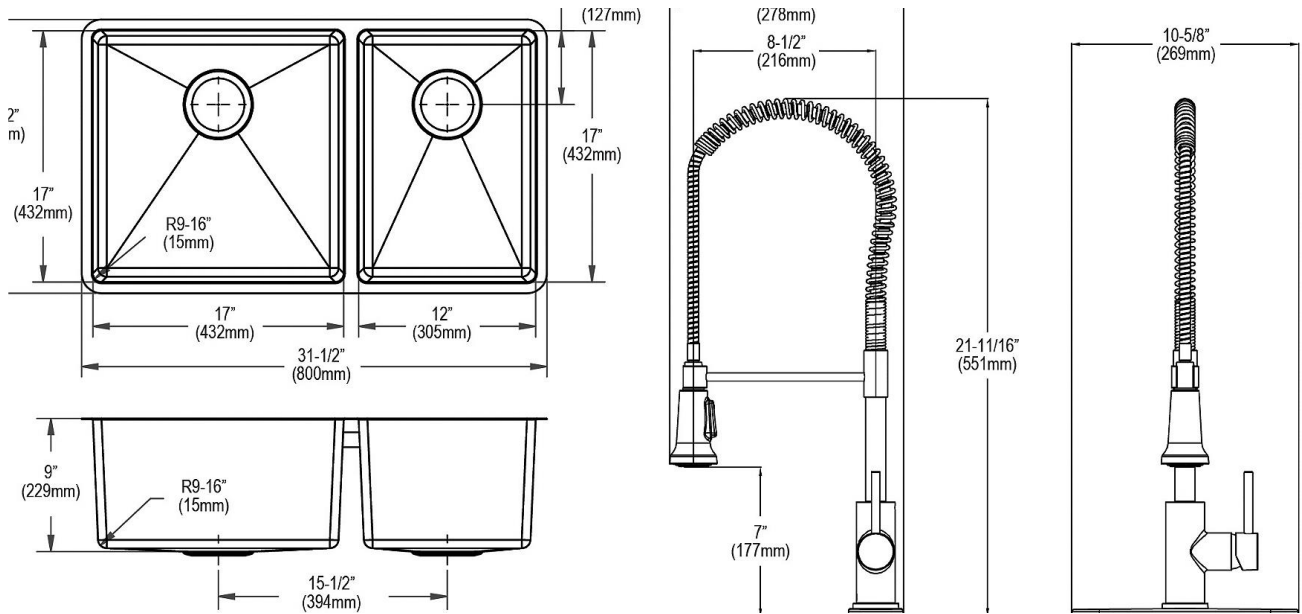
In keeping with our policy of continuing product improvement, Elkay reserves the right to change product specifications without notice. Please visit elkay.com for the most current version of Elkay product specification sheets. This specification describes an Elkay product with design, quality, and functional benefits to the user. When making a comparison of other producers' offerings, be certain these features are not overlooked.

Included Accessories		
LKAV2061CR	Avado [®] Single Hole Kitchen Faucet with Semi-professional Spout and Lever Handle Chrome Spec Sheet (PDF)	
LKDD	3-1/2" Drain Fitting Deep Strainer Basket Spec Sheet (PDF)	

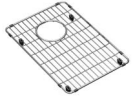

Optional Accessories		
LKDD	3-1/2" Drain Fitting Deep Strainer Basket Spec Sheet (PDF)	
LKAV2061	Avado [®] Single Hole Kitchen Faucet with Semi-professional Spout and Lever Handle Spec Sheet (PDF)	
CTXBG1015	Crosstown [®] Stainless Steel 10-1/2" x 15-1/2" x 1-1/4" Bottom Grid Spec Sheet (PDF)	
CTXBG1515	Crosstown [®] Stainless Steel 15-1/2" x 15-1/2" x 1-1/4" Bottom Grid Spec Sheet (PDF)	

In keeping with our policy of continuing product improvement, Elkay reserves the right to change product specifications without notice. Please visit elkay.com for the most current version of Elkay product specification sheets. This specification describes an Elkay product with design, quality, and functional benefits to the user. When making a comparison of other producers' offerings, be certain these features are not overlooked.