

**PRODUCT SPECIFICATIONS**

Circuit Chef® Workstation Stainless Steel 45-1/2" x 20-1/2" x 10" Single Bowl Undermount Sink Kit with Black Polymer Boards. Sink is manufactured from 16 gauge 304 Stainless Steel with a Stainless Steel finish, Rear Right drain placement, and Sides and Bottom pads.

<b>Installation Type:</b>	Sink Kits, Undermount
<b>Material:</b>	304 Stainless Steel
<b>Special Features:</b>	Workstation
<b>Finish:</b>	Stainless Steel
<b>Gauge:</b>	16
<b>Sound Deadening:</b>	Sides and Bottom pads
<b>Number of Bowls:</b>	1
<b>Sink Dimensions:</b>	45-1/2" x 20-1/2" x 10"
<b>Bowl 1 Dimensions:</b>	43" x 18" x 10"
<b>Drain Size:</b>	3-1/2" (89mm)
<b>Drain Location:</b>	Rear Right
<b>Minimum Cabinet Size:</b>	48"
<b>Mounting Hardware:</b>	Yes
<b>Template Included:</b>	Yes
<b>Cutout Template #:</b>	<a href="#">1000005504</a>

Template is available for download at [elkay.com](#). CAD software will be required to open the template.

**Special Note:** Reserve Selection products are sold exclusively, in-store and online, through authorized wholesalers. This model requires a custom, deeper cabinet for installation. A minimum of 23 1/2" of space is required for the width of the sink to account for the 1/2" edge reveal, faucet, and backsplash.

**Installation Profile:**

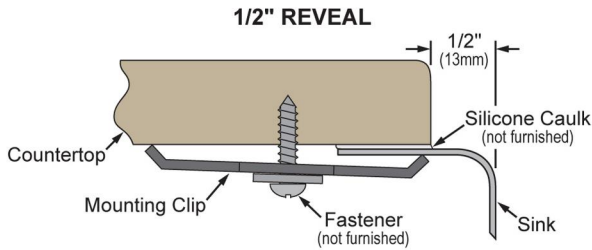

Designed to affix to the underside of any solid surface countertop.

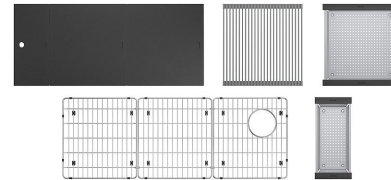

**Included with Product:** CSSCBP Small Colander, CS45BG Bottom Grid, CS45BP Black Polymer Cutting Boards, CSLPBP Low Profile Colander, LKDR1718RU Roll Up Drying Rack, LKDD

**▼ Ships in multiple boxes.**

A Century of Tradition and Quality. For more than 100 years, Elkay has been making innovative products and providing exceptional customer care. We take pride in offering plumbing products that make life easier, inspire change and leave the world a better place.

**Product Compliance:** ASME A112.19.3/CSA B45.4







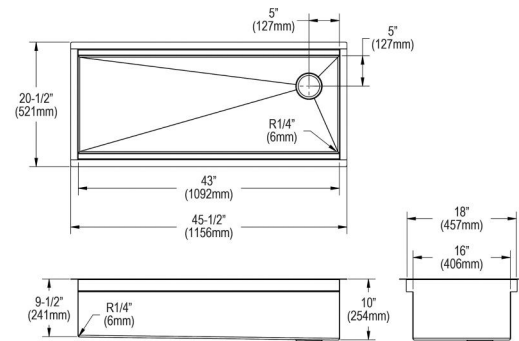



Sinks are listed by IAPMO® as meeting the applicable requirements of the Uniform Plumbing Code®, International Plumbing Code®, and National Plumbing Code of Canada.

[Clean and Care Manual \(PDF\)](#)  
[Installation Instructions \(PDF\) - 200000328](#)  
[Warranty \(PDF\)](#)



PART: \_\_\_\_\_ QTY: \_\_\_\_\_  
 PROJECT: \_\_\_\_\_  
 CONTACT: \_\_\_\_\_  
 DATE: \_\_\_\_\_  
 NOTES: \_\_\_\_\_  
 APPROVAL: \_\_\_\_\_

In keeping with our policy of continuing product improvement, Elkay reserves the right to change product specifications without notice. Please visit [elkay.com](#) for the most current version of Elkay product specification sheets. This specification describes an Elkay product with design, quality, and functional benefits to the user. When making a comparison of other producers' offerings, be certain these features are not overlooked.

Included Accessories		
<a href="#">CSSCBP</a>	Circuit Chef® Stainless Steel 17-3/4" x 8" x 4-1/2" Colander with Black Polymer Handles <a href="#">Spec Sheet (PDF)</a>	
<a href="#">CS45BG</a>	Circuit Chef® Stainless Steel 42-7/16" x 15-3/8" x 1-1/4" Bottom Grid <a href="#">Spec Sheet (PDF)</a>	
<a href="#">CS45BP</a>	Circuit Chef® Black Polymer 43-3/4" x 18-3/4" x 1/2" Cutting Boards <a href="#">Spec Sheet (PDF)</a>	
<a href="#">CSLPBP</a>	Circuit Chef® Stainless Steel 17-3/4" x 18-3/4" x 1-1/2" Low Profile Colander with Black Polymer Handles <a href="#">Spec Sheet (PDF)</a>	
<a href="#">LKDR1718RU</a>	Circuit Chef® Gray Silicone 17-3/4" x 17-5/16" x 3/8" Roll Up Drying Rack <a href="#">Spec Sheet (PDF)</a>	
<a href="#">LKDD</a>	3-1/2" Drain Fitting Deep Strainer Basket <a href="#">Spec Sheet (PDF)</a>	
Optional Accessories		
<a href="#">CSLCBP</a>	Circuit Chef® Stainless Steel 17-3/4" x 11" x 4-1/2" Colander with Black Polymer Handles <a href="#">Spec Sheet (PDF)</a>	
<a href="#">CSLCBP</a>	Circuit Chef® Stainless Steel 17-3/4" x 11" x 4-1/2" Colander with Black Polymer Handles <a href="#">Spec Sheet (PDF)</a>	

*In keeping with our policy of continuing product improvement, Elkay reserves the right to change product specifications without notice. Please visit [elkay.com](http://elkay.com) for the most current version of Elkay product specification sheets. This specification describes an Elkay product with design, quality, and functional benefits to the user. When making a comparison of other producers' offerings, be certain these features are not overlooked.*