

PRODUCT SPECIFICATIONS

Celebrity[®] Stainless Steel 33" x 21-1/4" x 6-7/8" Equal Double Bowl Drop-in Sink. Sink is manufactured from 20 gauge 304 Stainless Steel with a Brushed Satin finish, Center drain placement, and Bottom only pads.

Installation Type:	Drop-in
Material:	304 Stainless Steel
Finish:	Brushed Satin
Gauge:	20
Sound Deadening:	Bottom only pads
Number of Bowls:	2
Sink Dimensions:	33" x 21-1/4" x 6-7/8"
Bowl 1 Dimensions:	14" x 15-3/4" x 6-3/4"
Bowl 2 Dimensions:	14" x 15-3/4" x 6-3/4"
Drain Size:	3-1/2" (89mm)
Drain Location:	Center
Minimum Cabinet Size:	36"
Mounting Hardware:	Part # 64090014 included for countertops up to 3/4" (19mm) thick
Template Included:	No
Cutout Template #:	1000001288

Template is available for download at elkay.com. CAD software will be required to open the template.

Cutout Dimensions for Drop-in Installation:
32-3/8" x 20-5/8" (822mm x 524mm) with 1-1/2" (38mm) corner radius

Hole Drilling Configurations:

1-1/2" (38mm) Diameter Faucet Holes on 4" (102mm) Centers

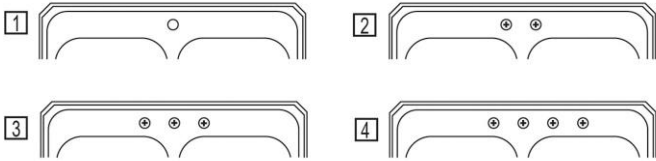

A Century of Tradition and Quality. For more than 100 years, Elkay has been making innovative products and providing exceptional customer care. We take pride in offering plumbing products that make life easier, inspire change and leave the world a better place.



Product Compliance: ASME A112.19.3/CSA B45.4



Sinks are listed by IAPMO[®] as meeting the applicable requirements of the Uniform Plumbing Code[®], International Plumbing Code[®], and National Plumbing Code of Canada.

[Clean and Care Manual \(PDF\)](#)
[Installation Instructions \(PDF\) - 1000005236](#)
[Warranty \(PDF\)](#)

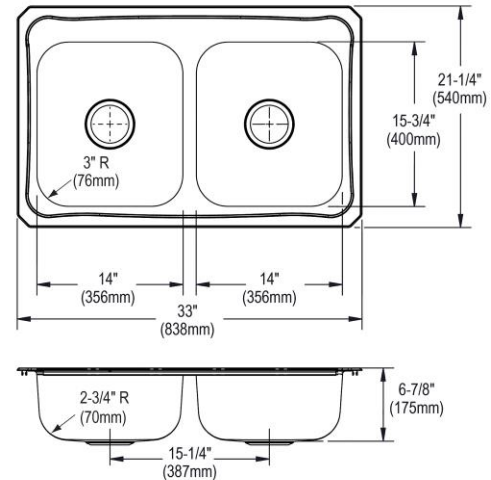





PART: _____ QTY: _____
 PROJECT: _____
 CONTACT: _____
 DATE: _____
 NOTES: _____
 APPROVAL: _____

In keeping with our policy of continuing product improvement, Elkay reserves the right to change product specifications without notice. Please visit elkay.com for the most current version of Elkay product specification sheets. This specification describes an Elkay product with design, quality, and functional benefits to the user. When making a comparison of other producers' offerings, be certain these features are not overlooked. Latest version of the spec sheet available: https://www.elkayfiles.com/spec-sheets/CR3321_spec.pdf

Installation Profile:

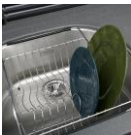

Optional Accessories		
LKWBG1415SS	Stainless Steel 12" x 13-1/2" x 1" Bottom Grid Spec Sheet (PDF)	
CB1516	Hardwood 15" x 16-3/4" x 3/4" Cutting Board Spec Sheet (PDF)	
LK99	Deluxe 3-1/2" Drain Type 304 Stainless Steel Body Strainer Basket Rubber Seal and Tailpiece Spec Sheet (PDF)	
LKGT1041	Elkay Gourmet Single Hole Kitchen Faucet Pull-out Spray and Lever Handle with Hi and Mid-rise Base Options Spec Sheet (PDF)	
LKWERBSS	Stainless Steel 15-3/8" x 12-3/8" x 5-7/16" Rinsing Basket Spec Sheet (PDF)	

In keeping with our policy of continuing product improvement, Elkay reserves the right to change product specifications without notice. Please visit elkay.com for the most current version of Elkay product specification sheets. This specification describes an Elkay product with design, quality, and functional benefits to the user. When making a comparison of other producers' offerings, be certain these features are not overlooked. Latest version of the spec sheet available: https://www.elkayfiles.com/spec-sheets/CR3321_spec.pdf