

Metal Framing Channels

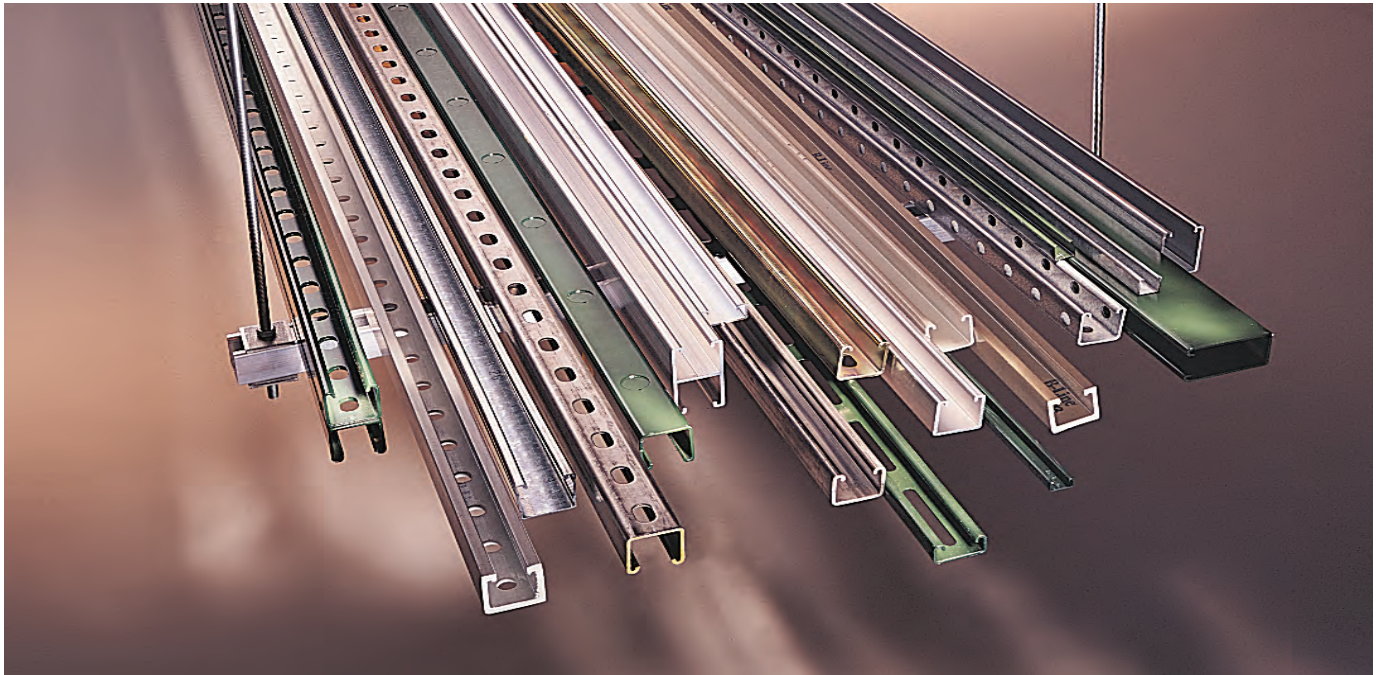

Channel

Metal framing channel is cold formed on our modern rolling mills from 12 Ga. (2.6mm), 14 Ga. (1.9mm), and 16 Ga. (1.5mm) low carbon steel strips. A continuous slot with inturned lips provides the ability to make attachments at any point.

Lengths & Tolerances

All channels excluding 'SH' style $\pm 1/8"$ (3.2mm) on 10' (3.05m) and $\pm 3/16"$ (4.76mm) on 20' (6.09m)

All 'SH' channels only $\pm 1/4"$ (6.35mm) on 10' (3.05m) and $\pm 1/2"$ (12.70mm) on 20' (6.09m)

Custom lengths are available upon request.

Slots

Slotted series of channels offer full flexibility. A variety of pre-punched slot patterns eliminate the need for precise field measuring for hole locations. Slots offer wide adjustments in the alignment and bolt sizing.

Holes

A variety of pre-punched $9/16"$ (14.3 mm) diameter hole patterns are available in our channels. These hole patterns provide an economical alternative to costly field drilling required for many applications.

Knockouts

When used with series B217-20 Closure Strips, knockout channels can be used to provide an economical U.L. listed surface raceway. Channels are furnished with $7/8"$ (22.2 mm) knockouts on 6" (152 mm) centers, allowing for perfect fixture alignment on spans up to 20' (6.09 m).

Materials & Finishes (Unless otherwise noted)

Steel: Plain & Pre-galvanized

12 Ga. (2.6), 14 Ga. (1.9) and 16 Ga. (1.5)

Note: A minimum order may apply on special material and finishes.

Design Load (Steel & Stainless Steel)

The design loads given for strut beam loads are based on a simple beam condition using an allowable stress of 25,000 psi. This allowable stress results in a safety factor of 1.68. This is based upon virgin steel minimum yield strength of 33,000 psi cold worked during rolling to an average yield stress of 42,000 psi. For aluminum channel loading multiply steel loading by a factor of 0.38.

Welding







Weld spacing is maintained between 2 $1/2$ inches (63.5 mm) and 4 inches (101.6 mm) on center. Through high quality control testing of welded channels and continuous monitoring of welding equipment, we provide the most consistent combination channels available today.

Metric

Metric dimensions are shown in parentheses. Unless noted, all metric dimensions are in millimeters.

Finish Code	Finish	Specification
PLN	Plain	ASTM A1011, 33,000 PSI min. yield
GRN	DURA GREEN™	
GLV	Pre-Galvanized	ASTM A653 33,000 PSI min. yield
HDG	Hot-Dipped Galvanized	ASTM A123
YZN	Yellow Zinc Chromate	ASTM B633 SC3 Type II
SS4	Stainless Steel Type 304	ASTM A240
SS6	Stainless Steel Type 316	ASTM A240
AL	Aluminum	Aluminum 6063-T6

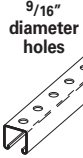
Selection Chart for Channels, Materials and Hole Patterns

Channel Type	Channel Dimensions		Material & Thickness * Stainless Steel				Channel Hole Pattern **				
	Height 	Width 	Steel	Alum.	Type 304	Type 316	SH	S	H17/8	TH	KO6
			1	2	3	4					
B11	3 1/4" (82.5)	1 5/8" (41.3)	12 Ga.	.105	–	–	1	1	1	–	1
B12	2 7/16" (61.9)	1 5/8" (41.3)	12 Ga.	.105	–	–	1 2	1	1 2	–	1 2
B22	1 5/8" (41.3)	1 5/8" (41.3)	12 Ga.	.105	12 Ga.	12 Ga.	1 2 3 4	1 3	1 2 3 4	1	1 2
B24	1 5/8" (41.3)	1 5/8" (41.3)	14 Ga.	.080	14 Ga.	14 Ga.	1 2 3 4	1	1 2 3 4	–	1 2
B26	1 5/8" (41.3)	1 5/8" (41.3)	16 Ga.	–	–	–	1	1	1	–	1
B32	1 3/8" (34.9)	1 5/8" (41.3)	12 Ga.	–	12 Ga.	–	1 3	1	1 3	–	1
B42	1" (25.4)	1 5/8" (41.3)	12 Ga.	–	12 Ga.	–	1 3	1	1 3	–	1
B52	1 3/16" (20.6)	1 5/8" (41.3)	12 Ga.	–	12 Ga.	12 Ga.	1 3 4	1	1	–	1
B54	1 3/16" (20.6)	1 5/8" (41.3)	14 Ga.	.080	14 Ga.	14 Ga.	1 2 3 4	1	1 2 3 4	–	1 2
B56	1 3/16" (20.6)	1 5/8" (41.3)	16 Ga.	–	–	–	1	1	1	–	1
B62	1 3/16" (20.6)	1 3/16" (20.6)	18 Ga.	–	–	–	–	–	–	–	–
B72	1 3/32" (10.3)	1 3/16" (20.6)	18 Ga.	–	–	–	–	–	–	–	–

The selection has been prepared to provide a reference for available channel, materials and hole patterns. Material types available for various hole patterns are defined by numbers 1 thru 4. Some stainless steel channels with hole patterns are available on special order only.

*Metric equivalent for thicknesses shown in chart. ** 1 - Steel
 12 Ga. = 2.6 mm 18 Ga. = 1.2 mm 2 - Aluminum
 14 Ga. = 1.9 mm .105 = 2.6 mm 3 - Type 304 Stainless Steel
 16 Ga. = 1.5 mm .080 = 2.0 mm 4 - Type 316 Stainless Steel

Properties may vary due to commercial tolerances of the material.

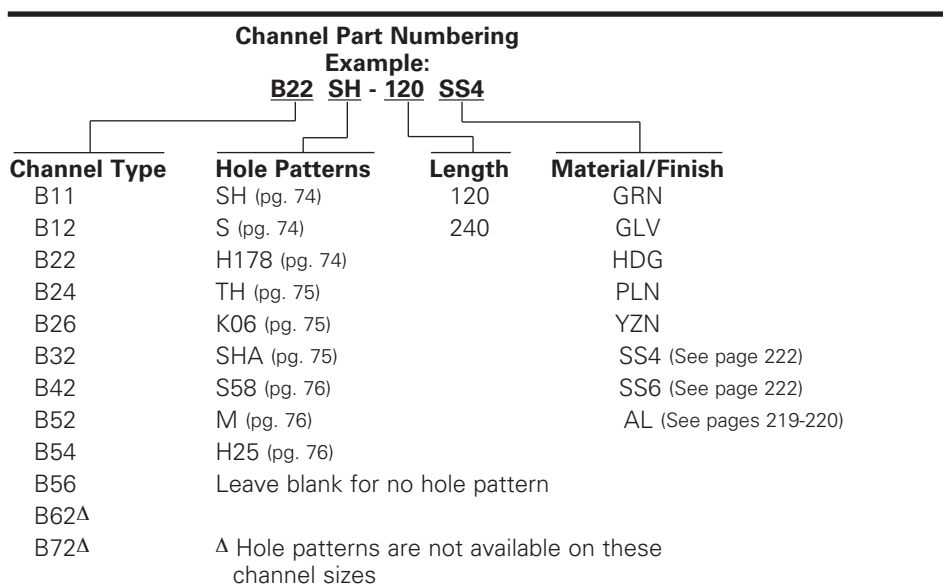

Reference page 48 for general fitting and standard finish specifications.

Telescoping Channel

BTS22TH

- Can be secured at any point of system
- Order BTS22TH & B22TH separately
- Thickness: 12 Gauge (2.6 mm)
- Standard lengths: 10' (3.05 m)
- Standard finishes: DURA GREEN™, Yellow Zinc Dichromate, Hot-Dipped Galvanized

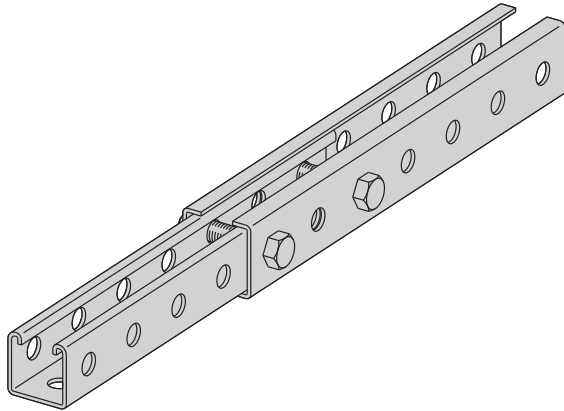

Slip Load Data

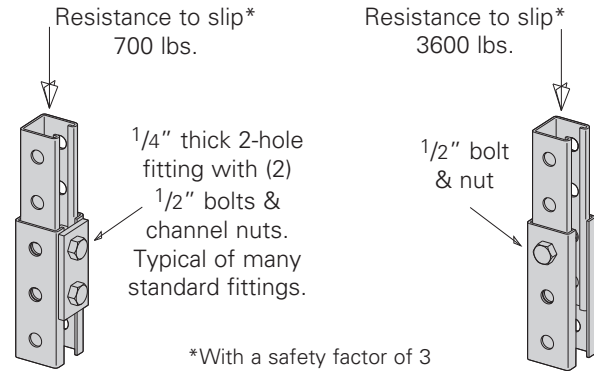

BTS22TH Telescoping Strut

Fits over all 1 5/8" x 1 5/8" channels 9/16" holes on 1 7/8" centers 12 gauge material thickness

Section Properties			X-X Axis				Y-Y Axis			
Channel	Weight lbs./ft.	Area In ²	C _x In	I _x In ⁴	S _x In ³	r _x In	C _y In	I _y In ⁴	S _y In ³	r _y In
BTS22TH	1.934	0.4578	1.0009	0.2525	0.2523	0.7426	0.9375	0.2757	0.2941	0.7761

Section properties are based on nominal metal thickness, and overall dimensions.

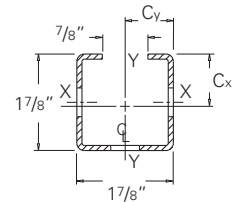

B22TH Three Hole Strut

9/16" holes on 1 7/8" centers 12 gauge material thickness

Section Properties			X-X Axis				Y-Y Axis			
Channel	Weight lbs./ft.	Area In ²	C _x In	I _x In ⁴	S _x In ³	r _x In	C _y In	I _y In ⁴	S _y In ³	r _y In
B22TH	1.760	0.3863	0.8245	0.1596	0.1936	0.6400	0.8125	0.1719	0.2116	0.6642

Section properties are based on nominal metal thickness, and overall dimensions.

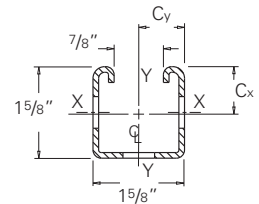

Combination of BTS22TH & B22TH

Section Properties			X-X Axis				Y-Y Axis			
Channel Combination	Weight lbs./ft.	Area In ²	C _x In	I _x In ⁴	S _x In ³	r _x In	C _y In	I _y In ⁴	S _y In ³	r _y In
BTS22TH/B22TH	3.597	0.8474	0.9773	0.4126	0.4222	0.6978	0.9375	0.4476	0.4774	0.7268

Section properties are based on nominal metal thickness, and overall dimensions.

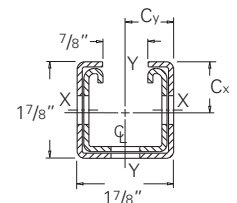

Reference page 48 for general fitting and standard finish specifications.