

## Feed-Through Wireway Type 4X

### Illustration Sheet and Catalog Number

### Subclass: Z70

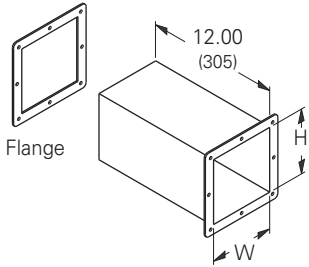

#### Cut-Off Fitting

- Length up to 12.00" (305 mm)
- Shorten to desired length and weld on flange

Catalog Number	Size	H in. mm	W in. mm
44-4XSFCF	4 x 4	4.00 102	4.00 102
66-4XSFCF	6 x 6	6.00 152	6.00 152

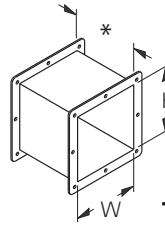

#### Nipple

- \* Lengths from 1.00" (25 mm) to 6.00" (152 mm)

Catalog Number	Size	H in. mm	W in. mm
44-4XSFN(*)	4 x 4	4.00 102	4.00 102
66-4XSFN(*)	6 x 6	6.00 152	6.00 152

- (\*) Insert **1** for 1" nipple (L = .938")
- Insert **2** for 2" nipple (L = 1.938")
- Insert **3** for 3" nipple (L = 2.938")
- Insert **6** for 6" nipple (L = 5.938")

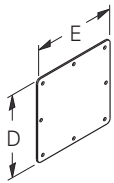

#### Closure Plate

- Includes hardware

Catalog Number	Size	D in. mm	E in. mm
44-4XSFCP	4 x 4	5.50 140	5.50 140
66-4XSFCP	6 x 6	7.75 197	7.75 197

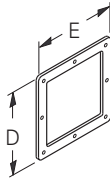

#### Box Connector

- Includes hardware

Catalog Number	Size	D in. mm	E in. mm
44-4XSFBC	4 x 4	5.50 140	5.50 140
66-4XSFBC	6 x 6	7.75 197	7.75 197

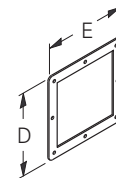

#### Gasket Kit

Catalog Number	Size	D in. mm	E in. mm
44-4XSGFK	4 x 4	5.50 140	5.50 140
66-4XSGFK	6 x 6	7.75 197	7.75 197

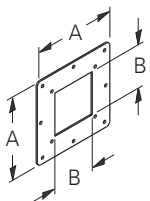

#### Center

#### Reducer

- Includes hardware

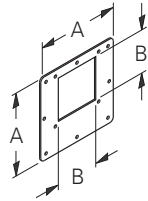

#### Edge

Catalog Number Center	Catalog Number Edge	Size	A in. mm	B in. mm
6644-4XSFR	6644-4XSFRE	6 to 4	5.50 140	4.00 102

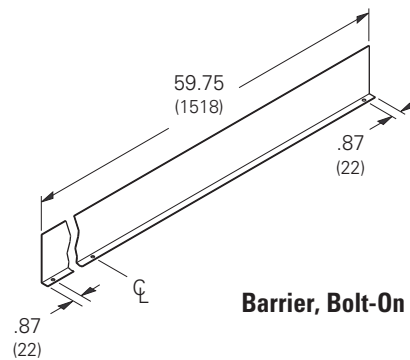

#### Barrier, Bolt-On

Catalog Number	Size	Height in. mm
44-12BK	4 x 4	3.00 76
66-12BK	6 x 6	4.50 114

**Notes:** Dimensions are in inches. Millimeters shown are for reference only. Data subject to change without notice.