

pro^{sense}® Thermocouple Spring-Loaded Probes with Hex Nipple

THMJ & K - HXXL01-02

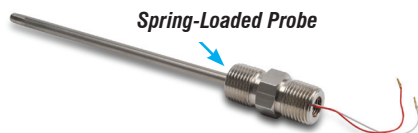

CHSC-AL-1



CHTB-2

Accessories

Overview

- Spring-loaded for positive tip contact in thermowells
- Type J or K thermocouple elements to meet many temperature sensing applications
- 1/4" diameter, 316 SS sheath to protect against harsh environments
- Magnesium Oxide (MgO) insulation provides vibration dampening and protection against thermal shock
- 4" , 6" or 12" probe length
- 316 SS, 1/2 x 1/2 NPT hex nipple allows easy replacement of existing probes and connection to a wiring junction box
- Made in the USA

Thermocouple Spring-Loaded Probes with Hex Nipple - Types J and K

Part Number	Pcs/Pkg	Wt (lb)	Price	Type	Probe Diameter (O.D.)	Probe Length	Temperature Sensing Range	Mounting
THMJ-H04L01-02	1	0.5	\$51.00	J	1/4"	4"	0 to 720°C (32 to 1330°F)	Integral 1/2" x 1/2" NPT Hex Nipple, 316 SS
THMJ-H06L01-02			\$56.00	J		6"		
THMJ-H12L01-02			\$59.00	J		12"		
THMK-H04L01-02			\$51.00	K		4"	0 to 927°C (32 to 1700°F)	
THMK-H06L01-02			\$56.00	K		6"		
THMK-H12L01-02			\$59.00	K		12"		

Technical Specifications

Junction Type	Ungrounded
ASTM E230 Standard Limits of Error	±2.2°C (±4.0°F) or 0.75%, whichever is greater
Probe	ø1/4", 316 stainless steel sheath, single thermocouple element is embedded in MgO powder
Response Time	2.9 seconds, 63.2% of a 25-77°C step change per method ASTM E839
Wiring	3 inch stranded 24 AWG wire leads with terminal pins, Teflon insulation

Note: See end of section for thermowells to fit these units.



Note: Check the chemical compatibility of the sensor's wetted parts with the medium to be measured.

proSense® Thermocouple Spring-Loaded Probes with Hex Nipple

Dimensions

inches [mm]

THMJ & K - HXXL01-02

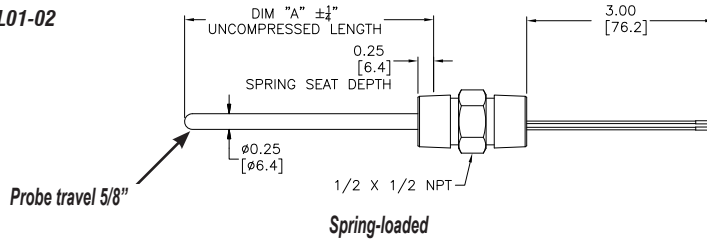

PART NUMBER	DIM "A"
THMJ-H04L01-02	4.00[101.6]
THMJ-H06L01-02	6.00[152.4]
THMJ-H12L01-02	12.00[304.8]
THMK-H04L01-02	4.00[101.6]
THMK-H06L01-02	6.00[152.4]
THMK-H12L01-02	12.00[304.8]

Wiring Information

Type J: (+) white (-) red
 Type K: (+) yellow (-) red

- Must use thermocouple extension lead wire
- Observe polarity when making connections
- Do not use standard wire nuts

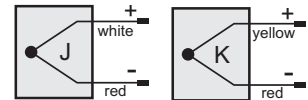

Accessories

Part No.	Description	Pcs/Pkg	Price
CHSC-AL-1	ProSense general purpose screw cover connection head for temperature probes, die-cast aluminum, 1/2 inch NPT process opening, 3/4 inch NPT conduit opening, NEMA 4X, IP66 rated, graphite gasket, maximum temperature rating of 825°F (440°C). Order probe and terminal base separately.	1	\$23.00
CHTB-2	ProSense ceramic terminal base, two brass terminals with stainless steel screws, for use with ProSense temperature probe connection heads, two mounting screws included.	1	\$6.00

Note: Full listing of accessories at the end of this section. Thermocouple extension lead wire available at www.automationdirect.com.

Dimensions

inches [mm]

CHSC-AL-1

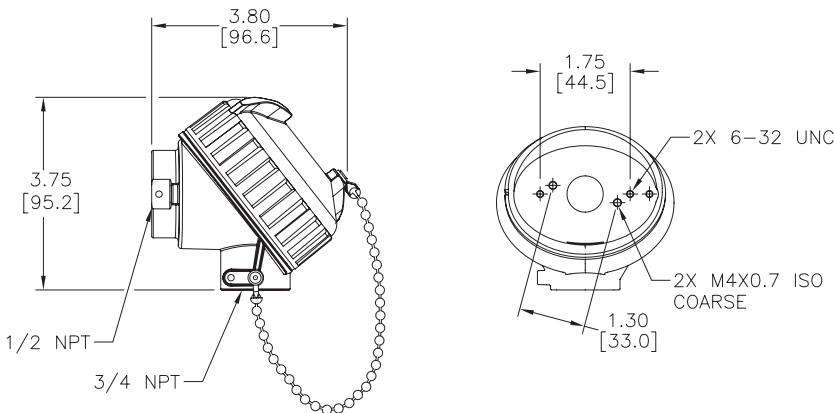

CHTB-2

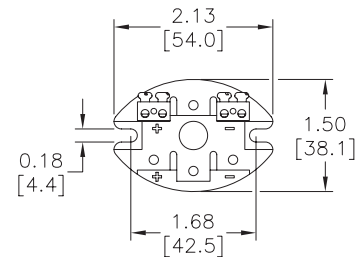

proSense® Thermocouple and RTD Connectors

Overview

- Glass-filled high quality thermoplastic body with original thermocouple material pins and spring-loaded inserts
- Polarized pins
- Molded barriers prevent short circuit
- Captive central cover screw for easy assembly
- Easy wire connection pressure plate
- construction
- Stainless steel screws with combination head (Slotted and Phillips)
- 3-pin standard connectors have a third pin for ground or continuous shield, or for 3-wire RTDs

Thermocouple and RTD Connectors									
Part Number	Pcs/ Pkg	Wt(lb)	Price	Sensor Type	Connector Type	Temperature Rating	Body Color	Wire Size	Wire Cable Clamp Bracket
THMJ-SP	1	0.5	\$4.00	J	Standard round pin plug	Max continuous 400°F (200°C)	Black	32 AWG (0.2 mm) to 14 AWG maximum (2.0 mm)	WCB-S
THMJ-SJ	1	0.5	\$5.25		Standard round pin jack				–
THMJ-SPJ	1	0.5	\$10.00		Standard round direct mount jack				–
THMJ-MP	1	0.5	\$3.75		Miniature flat pin plug			40 AWG (0.08 mm) to 20 AWG maximum (0.8 mm)	WCB-M
THMJ-MJ	1	0.5	\$4.25		Miniature flat pin jack				–
THMJ-MPJ	1	0.5	\$6.75		Miniature round direct mount jack				–
THMK-SP	1	0.5	\$4.50	K	Standard round pin plug	Max continuous 400°F (200°C)	Yellow	32 AWG (0.2 mm) to 14 AWG maximum (2.0 mm)	WCB-S
THMK-SJ	1	0.5	\$5.50		Standard round pin jack				–
THMK-SPJ	1	0.5	\$10.00		Standard round direct mount jack				–
THMK-MP	1	0.5	\$4.00		Miniature flat pin plug			40 AWG (0.08 mm) to 20 AWG maximum (0.8 mm)	WCB-M
THMK-MJ	1	0.5	\$4.25		Miniature flat pin jack				–
THMK-MPJ	1	0.5	\$7.50		Miniature round direct mount jack				–
THMK-HSP	1	0.5	\$13.00	RTD	Standard hi-temp round pin plug	Max continuous 662°F (350°C)	Brown	32 AWG (0.2 mm) to 14 AWG maximum (2.0 mm)	WCB-S
THMK-HSJ	1	0.5	\$15.00		Standard hi-temp round pin jack				
THMT-SP	1	0.5	\$4.25	T	Standard round pin plug	Max continuous 400°F (200°C)	Blue	32 AWG (0.2 mm) to 14 AWG maximum (2.0 mm)	–
THMT-SJ	1	0.5	\$5.75		Standard round pin jack				
THMT-SPJ	1	0.5	\$9.50		Standard round direct mount jack				
THMT-MP	1	0.5	\$4.00		Miniature flat pin plug			40 AWG (0.08 mm) to 20 AWG maximum (0.8 mm)	WCB-M
THMT-MJ	1	0.5	\$4.50		Miniature flat pin jack				–
THMT-MPJ	1	0.5	\$8.00		Miniature round direct mount jack				–
RTD-SP	1	0.5	\$9.00	RTD	Standard round pin plug		White	32 AWG (0.2 mm) to 14 AWG maximum (2.0 mm)	WCB-S
RTD-SJ	1	0.5	\$11.50		Standard round pin jack				

[THMT-SP](#)



[THMT-SJ](#)



[THMK-SP](#)



[THMK-SJ](#)



[THMK-MP](#)



[THMJ-MJ](#)



[THMT-SPJ](#)



[THMT-MPJ](#)



[RTD-SP](#)



[RTD-SJ](#)



[THMK-HSP](#)



[THMK-HSJ](#)



proense® Thermocouple and RTD Connectors

Dimensions

inches [mm]

THMJ, K, T, & H-SP

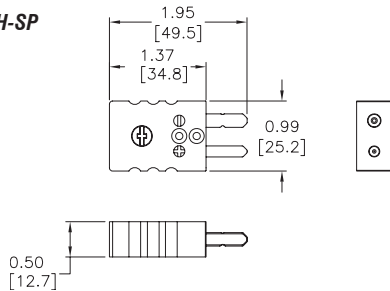

THMJ, K, T, & H-SJ

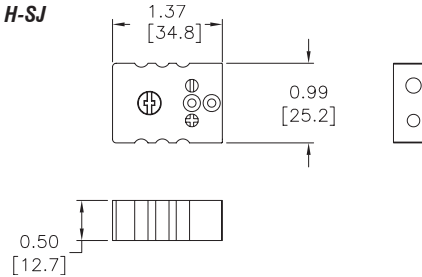

THMJ, K, & T-MP

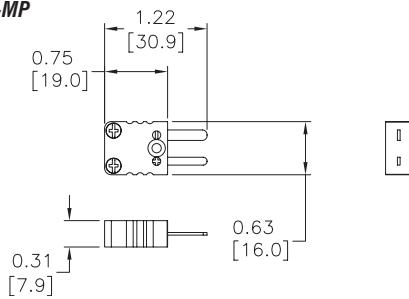

THMJ, K, & T-MJ

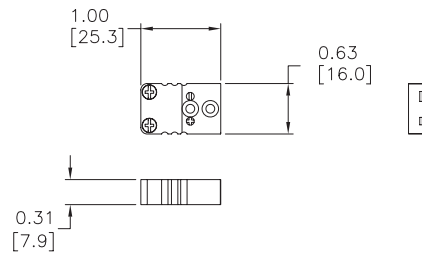

THMJ, K, & T-SPJ

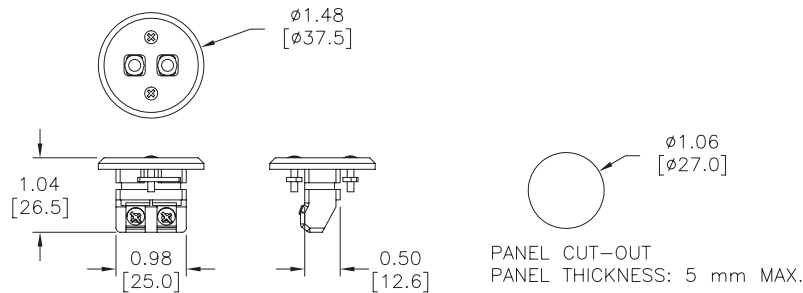

THMJ, K, & T-MPJ

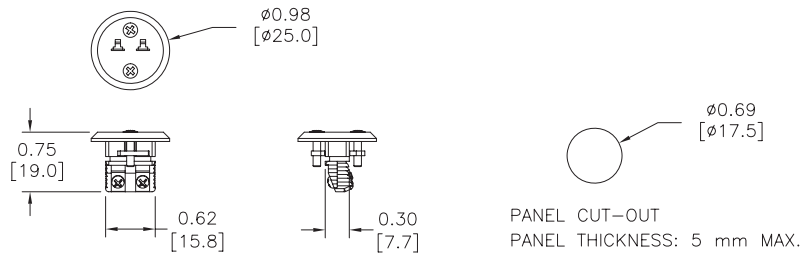

RTD-SP

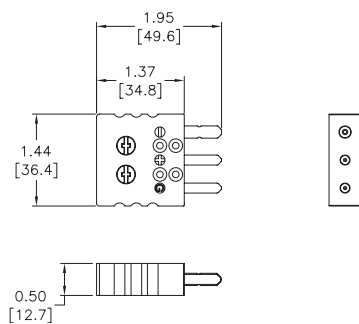

RTD-SJ

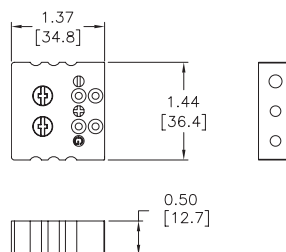

pro^{ense}® Thermocouple and RTD Connectors

WCB-S



WCB-M



WCB-S Application



WCB-M Application



Thermocouple and RTD Connectors Accessories				
Part Number	Pcs/ Pkg	Wt(lb)	Price	Description
WCB-S	4	0.5	\$7.00	Wire / cable clamp bracket for use with standard thermocouple and RTD connectors.
WCB-M	4	0.5	\$6.75	Wire / cable clamp bracket for use with miniature thermocouple connectors.

Dimensions

inches [mm]

WCB-S

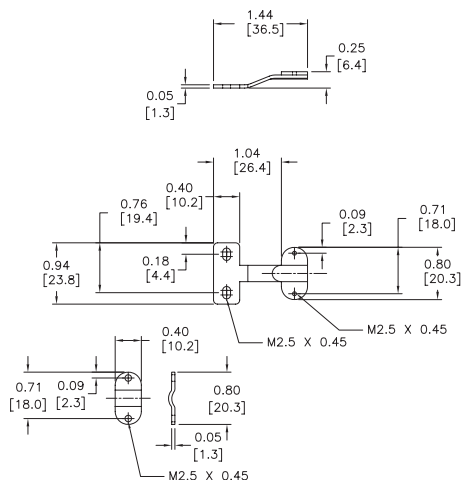

WCB-M

