

Stepping System Motors

SureStep® Stepping Motors

SureStep Series Part Numbers – Bipolar Stepping Motors*					
Bipolar Stepping Motors	Price	Shaft Type	Torque Level	Encoder Mounting	Drawing
STP-MTRL-14026	\$25.00	single	low	not available	PDF
STP-MTRL-14026D	\$29.50	dual		optional	PDF
STP-MTRL-14026E**	\$107.00	dual		pre-installed	PDF
STP-MTRL-14034	\$31.00	single		not available	PDF
STP-MTRL-14034D	\$36.50	dual		optional	PDF
STP-MTRL-14034E**	\$111.00	dual		pre-installed	PDF
STP-MTR-17040	\$22.50	single	high	not available	PDF
STP-MTR-17040D	\$26.50	dual		optional	PDF
STP-MTR-17040E**	\$103.00	dual		pre-installed	PDF
STP-MTR-17040W***	\$146.00	single		not available	PDF
STP-MTR-17048	\$26.50	single		not available	PDF
STP-MTR-17048D	\$31.00	dual		optional	PDF
STP-MTR-17048E**	\$108.00	dual		pre-installed	PDF
STP-MTR-17048W***	\$150.00	single		not available	PDF
STP-MTR-17060	\$43.00	single		not available	PDF
STP-MTR-17060D	\$48.50	dual		optional	PDF
STP-MTR-17060E**	\$125.00	dual		pre-installed	PDF
STP-MTR-17060W***	\$193.00	single		not available	PDF
STP-MTR-23055	\$42.50	single		not available	PDF
STP-MTR-23055D	\$48.50	dual		optional	PDF
STP-MTR-23055E**	\$126.00	dual	pre-installed	PDF	
STP-MTR-23055W***	\$181.00	single	not available	PDF	
STP-MTR-23079	\$55.00	single	not available	PDF	
STP-MTR-23079D	\$60.00	dual	optional	PDF	
STP-MTR-23079E**	\$137.00	dual	pre-installed	PDF	
STP-MTR-23079W***	\$196.00	single	not available	PDF	
STP-MTR-34066	\$129.00	single	high	not available	PDF
STP-MTR-34066D	\$146.00	dual		optional	PDF
STP-MTR-34066W***	\$234.00	single		not available	PDF
STP-MTRH-23079	\$61.00	single		not available	PDF
STP-MTRH-23079D	\$66.00	dual		optional	PDF
STP-MTRH-23079E**	\$144.00	dual		pre-installed	PDF
STP-MTRH-23079W***	\$291.00	single		not available	PDF
STP-MTRH-34066	\$144.00	single		not available	PDF
STP-MTRH-34066D	\$160.00	dual		optional	PDF
STP-MTRH-34066W***	\$331.00	single		not available	PDF
STP-MTRH-34097	\$163.00	single		not available	PDF
STP-MTRH-34097D	\$180.00	dual		optional	PDF
STP-MTRH-34097W***	\$371.00	single		not available	PDF
STP-MTRH-34127	\$192.00	single		not available	PDF
STP-MTRH-34127D	\$212.00	dual	optional	PDF	
STP-MTRH-34127W***	\$406.00	single	not available	PDF	

* For integrated motor/drives part numbers and pricing, see the integrated motor/drives section.

** E model motors come with an AMT112Q-V encoder pre-installed. Requires STP-CBL-EBxx for encoder wiring. To change from the default 400ppr, use AMT-PGRM-17C. See the SureStep Stepping System Encoders section for more details.

*** W models are IP65 washdown rated. All others are IP40.

**STP-MTR-xxxxx
(single-shaft)**



**STP-MTR-xxxxxE
(encoder mount)**



**STP-MTR-xxxxxD
(dual-shaft)**



**STP-MTR-xxxxxW
(IP65)**





Stepping System Motors

SureStep® Stepping Motors

SureStep Series Part Numbers – Bipolar Stepping Motors, continued					
Bipolar Stepping Motors	Price	Shaft Type	Torque Level	Encoder Mounting	Drawing
<i>Motors listing continued from previous page</i>					
STP-MTRAC-23044	\$63.00	single	High voltage High torque	not available	PDF
STP-MTRAC-23044D	\$64.00	dual		optional	PDF
STP-MTRAC-23055	\$71.00	single		not available	PDF
STP-MTRAC-23055D	\$72.00	dual		optional	PDF
STP-MTRAC-23078	\$99.00	single		not available	PDF
STP-MTRAC-23078D	\$100.00	dual		optional	PDF
STP-MTRAC-34075	\$265.00	single		not available	PDF
STP-MTRAC-34075D	\$265.00	dual		optional	PDF
STP-MTRAC-34115	\$274.00	single		not available	PDF
STP-MTRAC-34115D	\$275.00	dual		optional	PDF
STP-MTRAC-34156	\$295.00	single*		not available	PDF
STP-MTRAC-34156D	\$295.00	dual*		optional	PDF
STP-MTRAC-42100	\$244.00	single	High voltage Higher torque	not available	PDF
STP-MTRAC-42100D	\$265.00	dual		optional**	PDF
STP-MTRAC-42151	\$409.00	single		not available	PDF
STP-MTRAC-42151D	\$430.00	dual		optional**	PDF
STP-MTRAC-42202	\$501.00	single		not available	PDF
STP-MTRAC-42202D	\$519.00	dual		optional**	PDF
STP-MTRACH-42100	\$244.00	single		not available	PDF
STP-MTRACH-42100D	\$265.00	dual		optional**	PDF
STP-MTRACH-42151	\$409.00	single		not available	PDF
STP-MTRACH-42151D	\$430.00	dual		optional**	PDF
STP-MTRACH-42202	\$501.00	single		not available	PDF
STP-MTRACH-42202D	\$519.00	dual		optional**	PDF

* NOTE: STP-MTRAC-34156(x) motors have a 5/8" front shaft.

** NOTE: NEMA 42 "D" motors require an [STP-MTRA-42ENC](#) adapter plate for AMT13/AMT33 encoder mounting.

STP-MTRAC-xxxxx
(single-shaft)



STP-MTRAC-xxxxxD
(dual-shaft)



STP-MTRACH-42xxxD
(dual-shaft)



SureStep® Stepping Motors Mounting Accessories

Mounting Accessories – for NEMA 17 and NEMA 42 SureStep Stepping Motors				
Part Number	Price	Description	Drawing Links	Use With
STP-MTRA-RB-85	\$9.25	Reducer bushing, 8mm OD to 5mm ID, 16mm length, aluminum alloy. Connects NEMA size 17 stepper motors to Koyo TRD-NH and TRD-SH hollow shaft encoders.	n/a	SureStep NEMA 17 motors
STP-MTRA-42ENC	\$9.25	SureStep encoder mounting plate, metal body. For use with SureStep NEMA 42 stepper motors with dual shafts. Encoder mounting screws and mounting plate screws included. Mounting holes for CUI Devices AMT132/AMT332 encoders and US Digital E6 encoders.	PDF	SureStep NEMA 42 motors

STP-MTRA-42ENC





Stepping System Motors

SureStep® Stepping Motors

SureStep Series Specifications – Connectorized Bipolar Stepping Motors													
Bipolar Stepping Motors	Low Voltage Low Torque		Low Voltage High Torque						Low Voltage Higher Torque				
	STP-MTRL-14026(x)	STP-MTRL-14034(x)	STP-MTR-17040(x)	STP-MTR-17048(x)	STP-MTR-17060(x)	STP-MTR-23055(x)	STP-MTR-23079(x)	STP-MTR-34066(x)	STP-MTRH-23079(x)	STP-MTRH-34066(x)	STP-MTRH-34097(x)	STP-MTRH-34127(x)	
NEMA Frame Size	14	14	17	17	17	23	23	34	23	34	34	34	
Maximum Holding Torque*	(lb·in)	0.5	1.25	3.81	5.19	7.19	10.37	17.25	27.12	17.87	27.12	50.00	80.50
	(oz·in)	8	20	61	83	115	166	276	434	286	434	800	1288
	(N·m)	0.06	0.14	0.43	0.59	0.81	1.17	1.95	3.06	2.02	3.06	5.65	9.10
Rotor Inertia	(oz·in ²)	0.06	0.08	0.28	0.37	0.56	1.46	2.60	7.66	2.60	7.66	14.80	21.90
	(kg·cm ²)	0.0003	0.00035	0.05	0.07	0.10	0.27	0.48	1.40	0.48	1.40	2.71	4.01
Rated Current (A/phase)	0.35	0.8	1.7	2.0	2.0	2.8	2.8	2.8	5.6	6.3	6.3	6.3	
Resistance (Ω/phase)	8.5	7.66	1.6	1.4	2.0	0.75	1.1	1.11	0.4	0.25	0.3	0.49	
Inductance (mH/phase)	5.77	6.92	3.0	2.7	3.3	2.4	3.8	6.6	1.2	1.5	2.1	4.1	
Insulation Class	130°C [266°F] Class B; 300V rms												
Basic Step Angle	1.8°												
Shaft Runout (in)	0.002 in [0.051 mm]												
Max Shaft Radial Play @ 1lb load	0.001 in [0.025 mm]												
Perpendicularity	0.003 in [0.076 mm]												
Concentricity	0.003 in [0.076 mm]												
Maximum Radial Load (lb [kg])*	6.0 [2.7]			15.0 [6.8]			39.0 [17.7]	15.0 [6.8]	39.0 [17.7]				
Maximum Thrust Load (lb [kg])*	6.0 [2.7]			13.0 [5.9]			25.0 [11.3]	13.0 [5.9]	25.0 [11.3]				
Storage Temperature Range	-20°C to 100°C [-4°F to 212°F]												
Operating Temperature Range	-20°C to 50°C [-4°F to 122°F] (motor case temperature should be kept below 80°C [176°F])												
Operating Humidity Range	55% to 85% non-condensing												
Product Material	steel motor case; stainless steel shaft(s)												
Environmental Rating	IP40 (IP65 for "W" motors)												
Weight (lb [kg]) (E models)	0.25 [0.11] (0.3 [0.1])	0.35 [0.15] (0.4 [0.2])	0.6 [0.3] (0.7 [0.3])	0.7 [0.3] (0.8 [0.4])	0.9 [0.4] (0.9 [0.4])	1.5 [0.7] (1.5 [0.7])	2.2 [1.0] (2.4 [1.1])	3.9 [1.7]	2.4 [1.1] (2.4 [1.1])	3.9 [1.7]	5.9 [2.7]	8.4 [3.8]	
Agency Approvals	CE												
Design Tips	Allow sufficient time to accelerate the load and size the step motor with a 100% torque safety factor. DO NOT disassemble step motors because motor performance will be reduced and the warranty will be voided. DO NOT connect or disconnect the step motor during operation. Mount the motor to a surface with good thermal conductivity, such as steel or aluminum, to allow heat dissipation. Use a flexible coupling with "clamp-on" connections to both the motor shaft and the load shaft to prevent radial and thrust loading on bearings from minor misalignment.												
Accessory Extension Cable	STP-EXTL-0xx		STP-EXT-0xx STP-EXTW-0xx (for "W" motors)						STP-EXTH-0xx STP-EXTHW-0xx (for "W" motors)				

* For dual-shaft motors (STP-MTR-xxxxxD):
The sum of the front and rear Torque Loads, Radial Loads, and Thrust Loads must not exceed the applicable Torque, Radial, and Thrust load ratings of the motor.



Stepping System Motors

SureStep® Stepping Motors

SureStep Series Specifications – High Voltage Bipolar Stepping Motors							
Bipolar Stepping Motors		High Voltage High Torque					
		STP-MTRAC-23044(x)	STP-MTRAC-23055(x)	STP-MTRAC-23078(x)	STP-MTRAC-34075(x)	STP-MTRAC-34115(x)	STP-MTRAC-34156(x)**
NEMA Frame Size		23	23	23	34	34	34**
Maximum Holding Torque*	(lb·in)	4.69	9.31	14.19	51.31	69.48	115.06
	(oz·in)	75	149	227	821	1110	1841
	(N·m)	0.53	1.05	1.6	5.8	7.84	13
Rotor Inertia	(oz·in ²)	0.66	1.64	2.62	7.38	14.74	24.06
	(g·cm ²)	120	300	480	1350	2700	4400
Rated Current (A/phase)	Series	0.71	0.71	0.71	2.15	2.05	2.55
	Parallel	1.41	1.41	1.41	4.3	4.1	5.1
Resistance (Ω/phase)	Series	12.4	14.4	18	4	4.8	4.8
	Parallel	3.1	3.6	4.5	1.0	1.2	1.375
Inductance (mH/phase)	Series	30.4	51.2	60.8	32	43.2	44.8
	Parallel	7.6	12.8	15.2	8.0	10.8	11.2
Insulation Class		B					
Steps per Revolution		200					
Basic Step Angle		1.8°					
Shaft Runout (in)		0.002 in 0.05 mm]					
Max Shaft Radial Play @ 1lb load		0.02 in [0.51 mm]			0.025 in [0.635 mm]		0.02 in [0.51 mm]
Max End Play @ 2.2-lb Axial load		0.08 in [2.03 mm]			0.075 in [1.91 mm]		0.08 in [2.03 mm]
Connectors		8 leads, 24AWG			8 leads, 22AWG		
Temperature Rise		80°C [176°F] max					
Storage Temperature Range		-40°C to 70°C [-40°F to 158°F]					
Operating Temperature Range		-20°C to 50°C [-4°F to 122°F]					
Operating Humidity Range		5% to 95% non-condensing					
Product Material		Steel motor case; stainless steel shaft(s)					
Environmental Rating		IP40					
Weight (lb [kg])		1.03 [0.47]	1.54 [0.7]	2.2 [1.0]	4.2 [1.9]	8.4 [3.8]	11.46 [5.2]
Agency Approvals		None			cURUs		

* For dual-shaft motors (STP-MTRAC-xxxxxD):

The sum of the front and rear Torque Loads, Radial Loads, and Thrust Loads must not exceed the applicable Torque, Radial, and Thrust load ratings of the motor.

** STP-MTRAC-34156(x) motors have a 5/8" front shaft



Stepping System Motors

SureStep® Stepping Motors

SureStep Series Specifications – Connectorized Stepping Motors							
Stepping Motors	Higher voltage High torque						
	STP-MTRAC-42100(x)	STP-MTRAC-42151(x)	STP-MTRAC-42202(x)	STP-MTRACH-42100(x)	STP-MTRACH-42151(x)	STP-MTRACH-42202(x)	
NEMA Frame Size	42	42	42	42	42	42	
Optional Encoder¹	Y	Y	Y	Y	Y	Y	
Max Holding Torque (N·m)	Unipolar Series	9.7	19.0	26.0	9.7	17.5	26.0
	Bipolar Series	12.2	22.0	31.0	12.3	22.0	32.0
	Bipolar Parallel	12.2	22.0	31.0	12.3	22.0	32.0
Rotor Inertia (g·cm²)	5500	10900	16200	5500	10900	16200	
Rated RMS Current (A/phase)	Unipolar Series	6	9.4	9	8.5	11.3	11.5
	Bipolar Series	4.2	6	6	6	8	8
	Bipolar Parallel	8.4	12	12	12	16	16
Resistance (Ω/phase)	Unipolar Series	0.6	0.34	0.46	0.32	0.215	0.29
	Bipolar Series	1.19	0.68	0.91	0.64	0.43	0.58
	Bipolar Parallel	0.3	0.17	0.23	0.159	0.108	0.144
Inductance (mH/phase)	Unipolar Series	5	3.6	5.5	2.5	1.9	3.2
	Bipolar Series	19.8	14.5	22	10.1	7.6	13
	Bipolar Parallel	5	3.6	5.5	2.5	1.9	3.2
Insulation Class	B						
Steps per Revolution	200						
Basic Step Angle	1.8°						
Shaft Runout	0.05 mm						
Max Shaft Radial Play @ 1lb load	1.1 in						
Connectors	8 leads, 18AWG						
Temperature Rise	80°C max						
Storage Temp.	-30°C to 70°C [-22°F to 158°F]						
Operating Temperature	-20°C to 40°C [-4°F to 104°F]						
Operating Humidity	5% to 95% non-condensing						
Product Material	Steel motor case, stainless steel shaft(s)						
Environmental Rating	IP40						
Weight (lb [kg])	10.6 [4.8]	17.6 [8]	25.6 [11.6]	10.6 [4.8]	17.6 [8]	25.6 [11.6]	
Agency Approval	cURus						

1 - Dual-shaft versions only. For US Digital E6 or CUI Devices AMT13/AMT33 encoder mounting, the STP-MTRA-42ENC encoder adapter plate is required.



Stepping System Motors

SureStep® Motor Running Torque vs. Speed Charts

STP-MTRL-14xxx(x) NEMA 14 Step Motors

STP-MTRL-14026(x) Torque vs Speed (1.8° step motor; 1/2 stepping, RMS phase current)

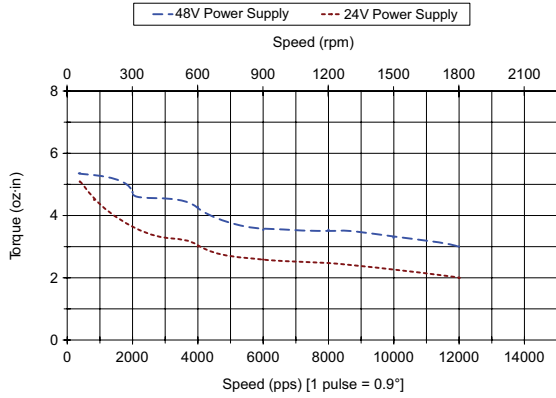

STP-MTRL-14034(x) Torque vs Speed (1.8° step motor; 1/2 stepping, RMS phase current)

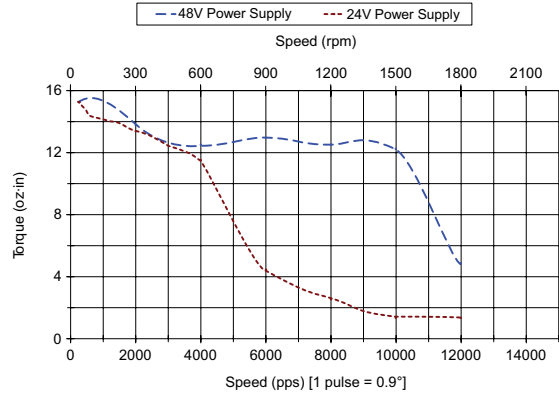

STP-MTR-17xxx(x) NEMA 17 Step Motors

Note: "W" series motors have 5% less running torque than other models

STP-MTR-17040(x) Torque vs Speed (1.8° step motor; 1/2 stepping)

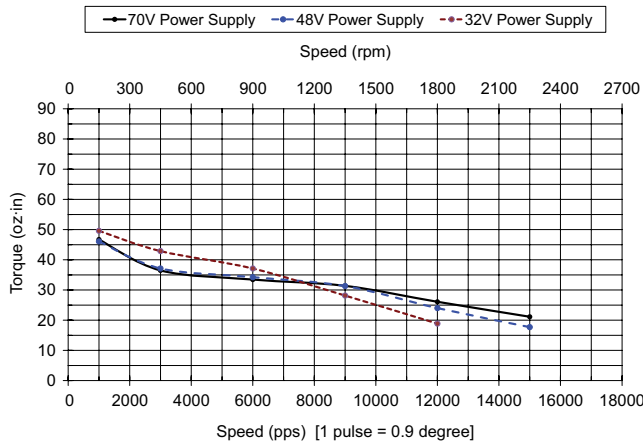

STP-MTR-17060(x) Torque vs Speed (1.8° step motor; 1/2 stepping)

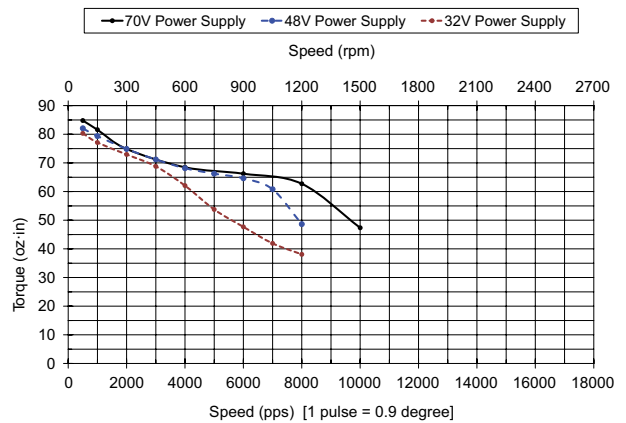

STP-MTR-17048(x) Torque vs Speed (1.8° step motor; 1/2 stepping)

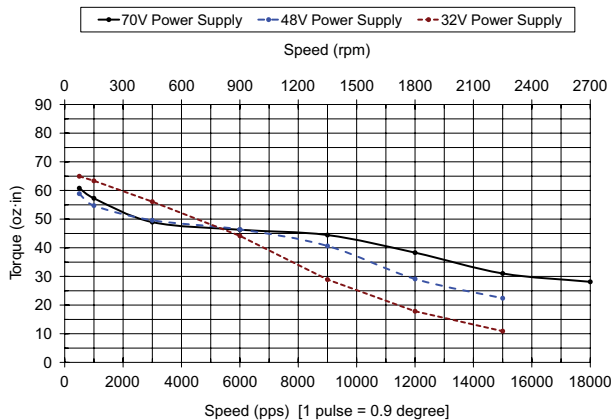

Note: Motor torque vs speed charts for STP-MTRD series integrated motor/drives can be found in the integrated motor/drives section of the full catalog



Stepping System Motors

SureStep® Motor Torque vs. Speed Charts (continued)

STP-MTR(H)-23xxx(x) NEMA 23 Step Motors

Note: "W" series motors have 5% less running torque than other models

STP-MTR-23055(x) Torque vs Speed (1.8° step motor; 1/2 stepping)

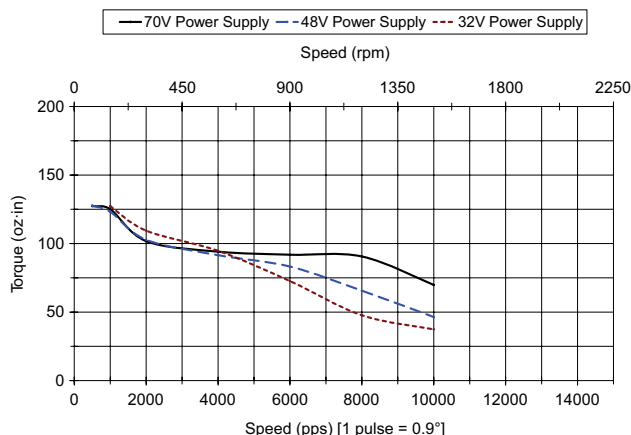

STP-MTRH-23079(x) Torque vs Speed (1.8° step motor; 1/2 stepping)

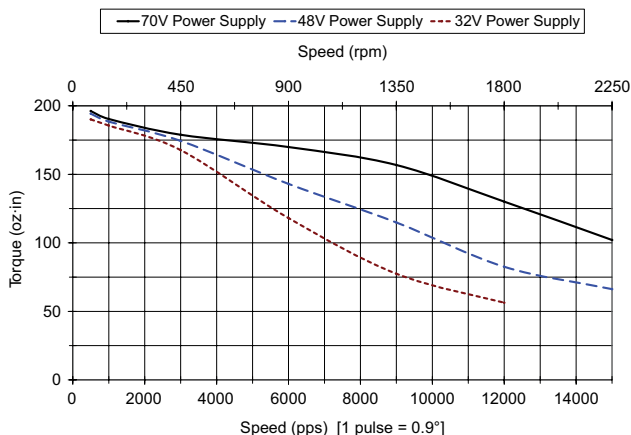

STP-MTR-23079(x) Torque vs Speed (1.8° step motor; 1/2 stepping)

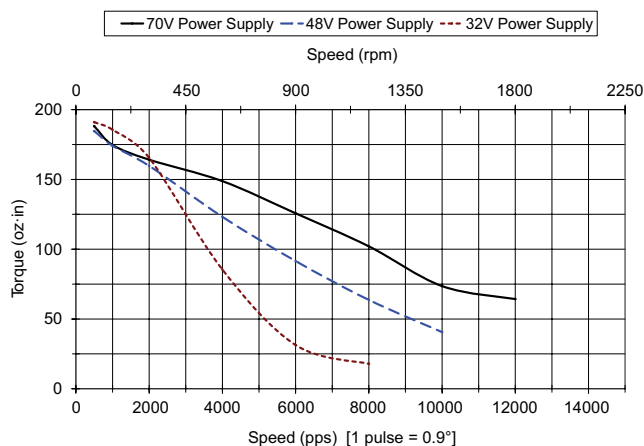

STP-MTRAC-23xxxx Torque vs Speed @ 340VDC bus (1.8° step motor; 1/2 stepping)

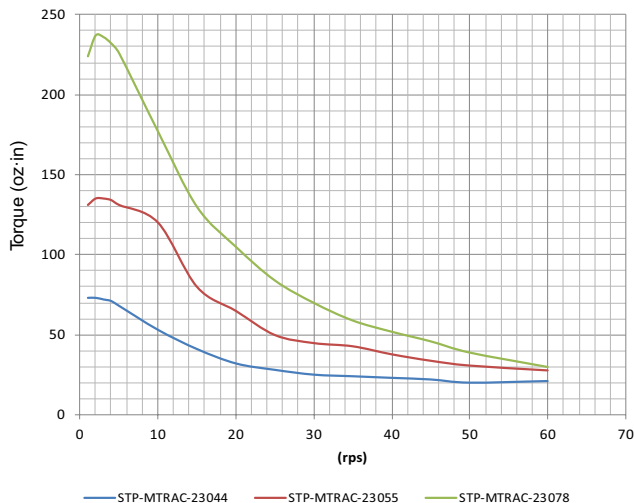



Stepping System Motors

SureStep® Motor Torque vs. Speed Charts (continued)

STP-MTR(H)-34xxx(x) NEMA 34 Step Motors

Note: "W" series motors have 5% less running torque than other models

STP-MTR-34066(x) Torque vs Speed (1.8° step motor; 1/2 stepping)

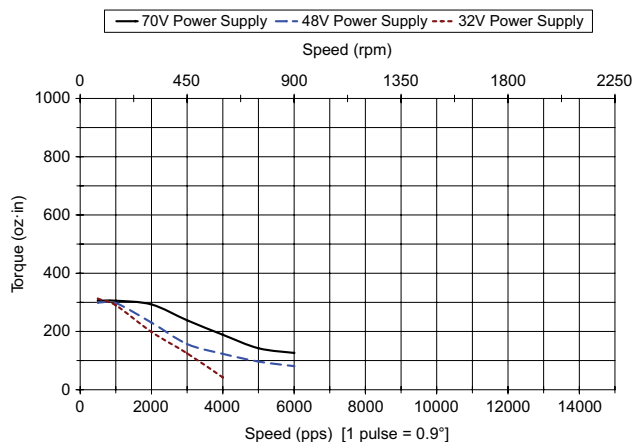

STP-MTRH-34066(x) Torque vs Speed (1.8° motor; 1/2 stepping)

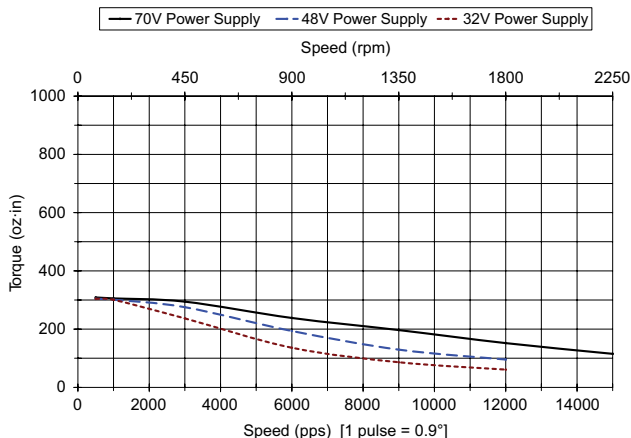

STP-MTRH-34097(x) Torque vs Speed (1.8° step motor; 1/2 stepping)

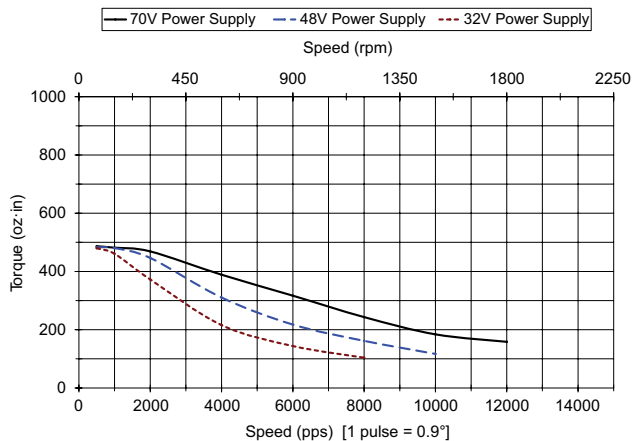

STP-MTRH-34127(x) Torque vs Speed (1.8° step motor; 1/2 stepping)

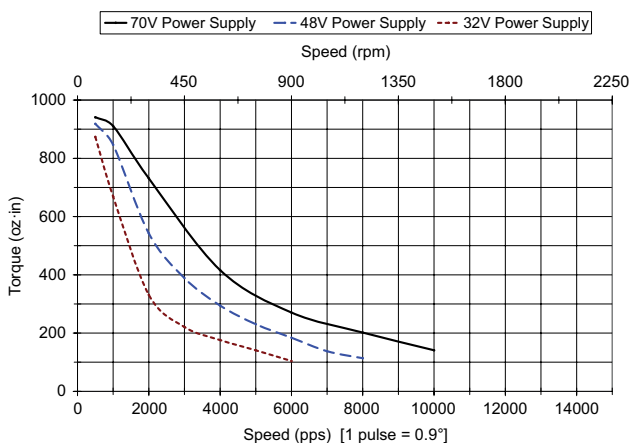

STP-MTRAC-34xxx Torque vs Speed @ 340VDC bus (1.8° step motor; 1/2 stepping)

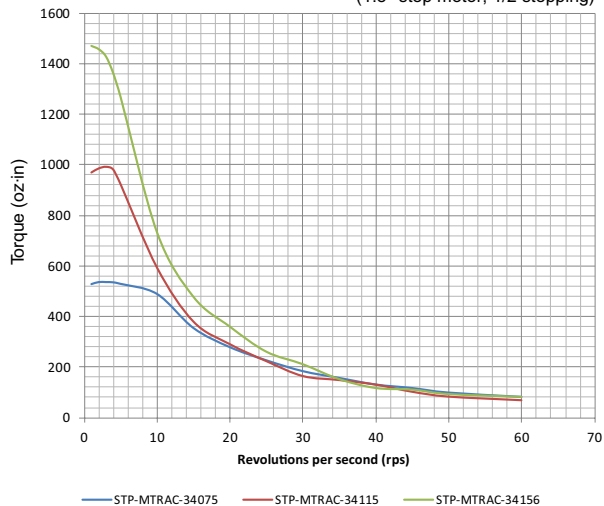

Stepping System Motors

SureStep[®] Motor Torque vs. Speed Charts (continued)

STP-MTRAC(H)-42xxx(x) NEMA 42 Step Motors

For all NEMA 42 charts: "S" = Series Bipolar Wiring
 "P" = Parallel Bipolar Wiring

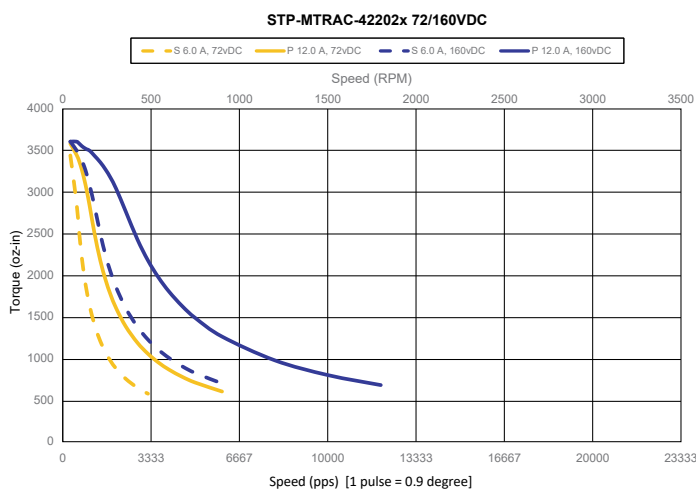
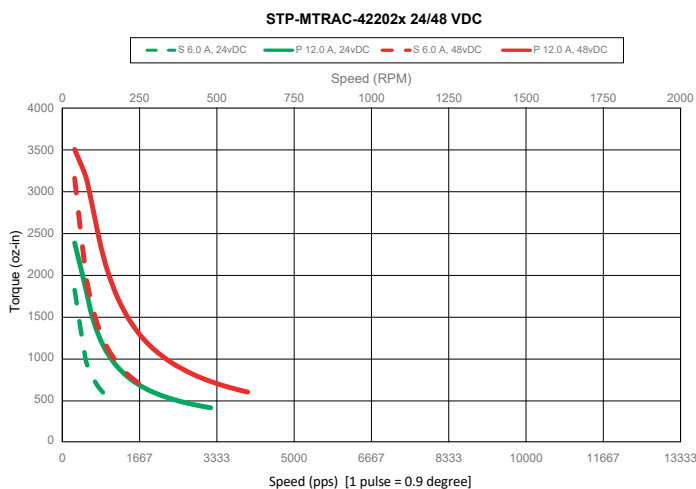
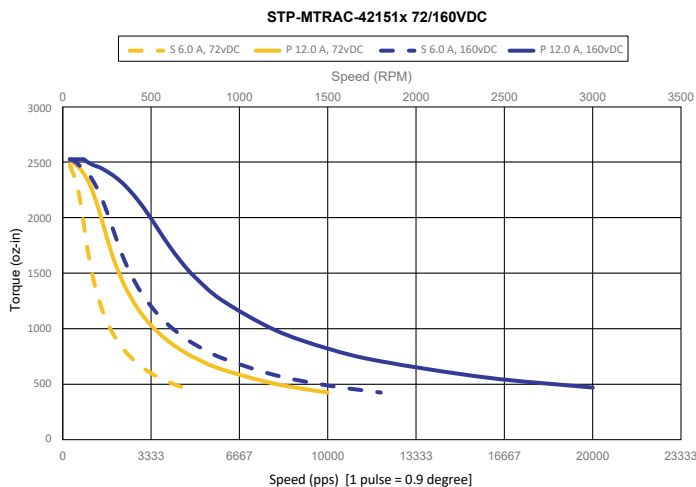
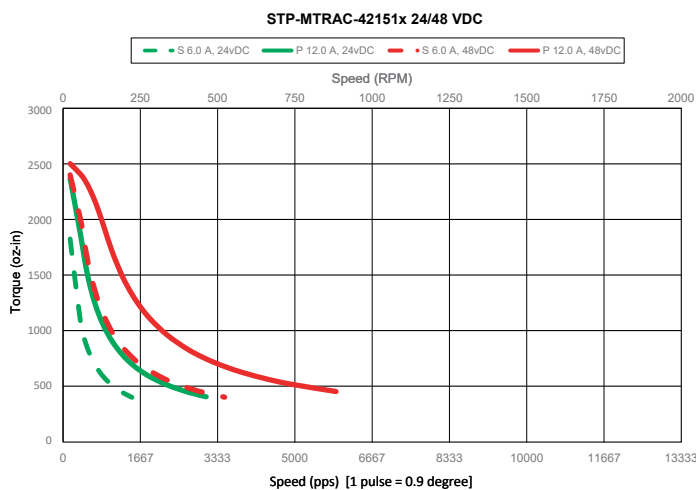
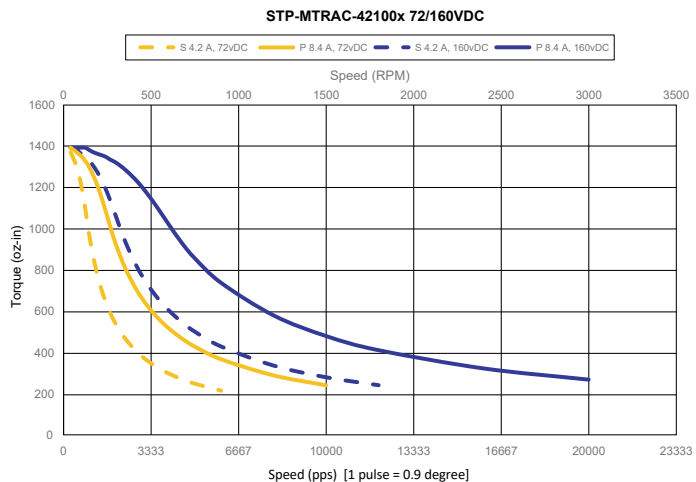
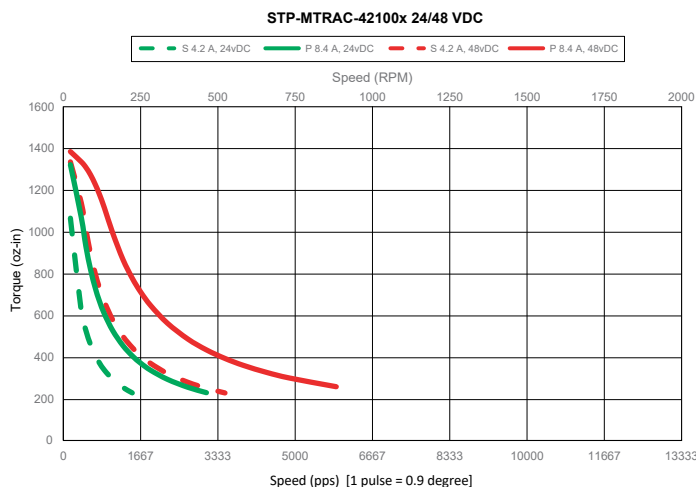

Stepping System Motors

SureStep® Motor Torque vs. Speed Charts (continued)

STP-MTRACH(H)-42xxx(x) NEMA 42 Step Motors

For all NEMA 42 charts: "S" = Series Bipolar Wiring
"P" = Parallel Bipolar Wiring

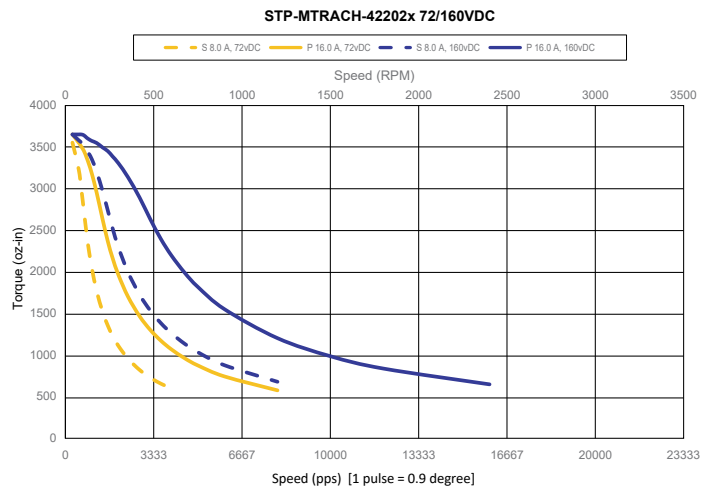
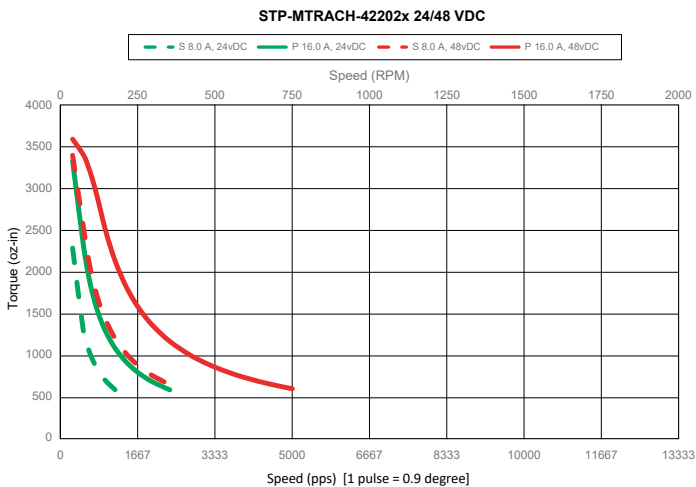
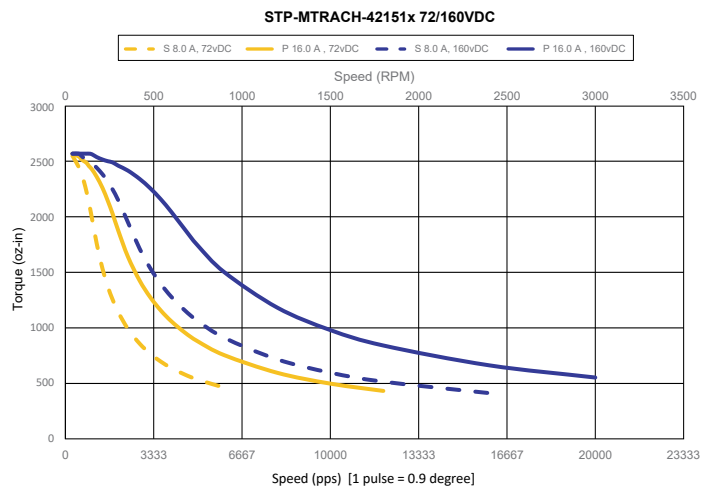
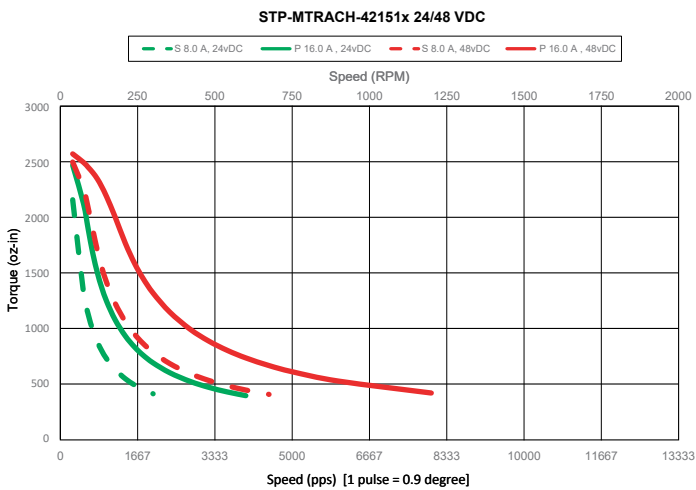
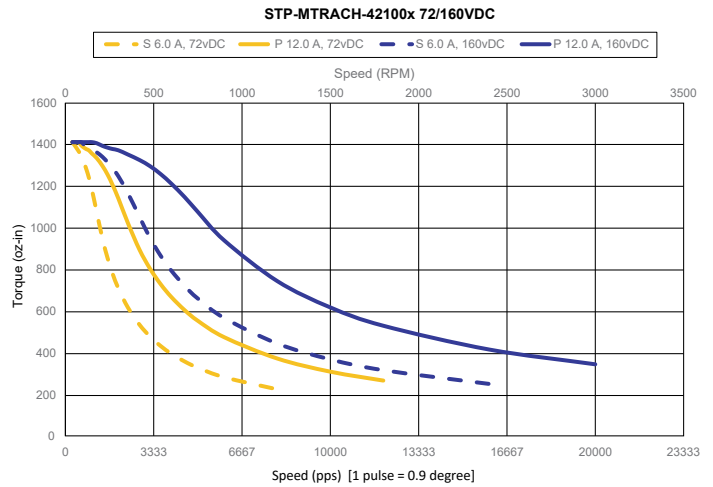
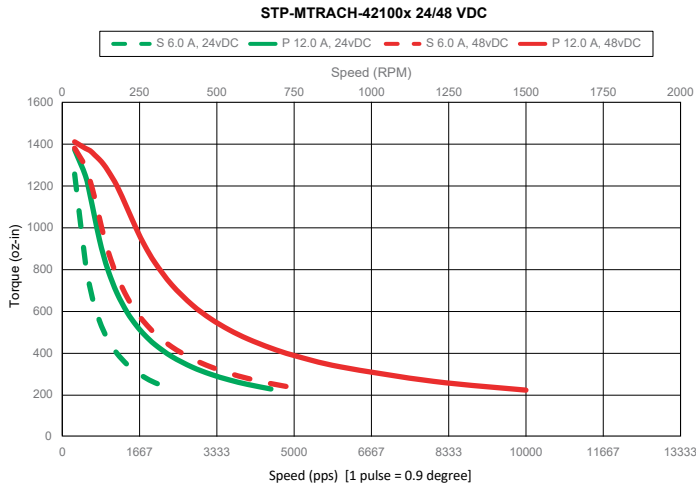



Stepping System Motors

SureStep® Motor Dimensions and Cabling

STP-MTR(x)-14,17,23xxx(X) Motors

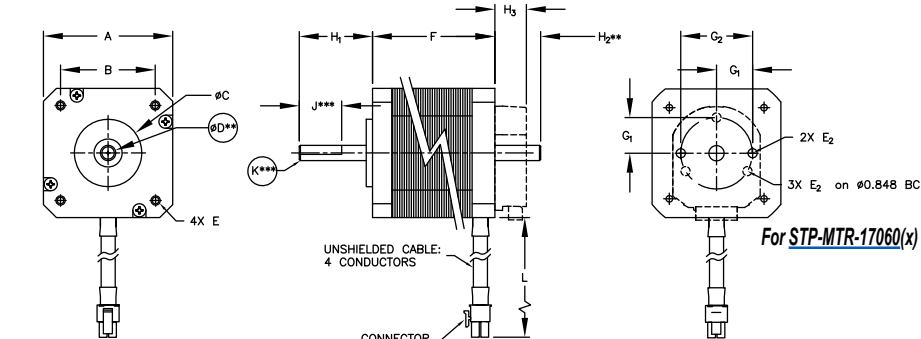

PIN # 1
CONNECTOR: VIEW FROM WIRE ENTRANCE

EXTL MOTORS		
PIN #	COLOR	PHASE
1	RED	A+
2	YELLOW	A-
3	GREEN	B+
4	BLACK	B-

PIN # 1, PIN # 2, PIN # 3, PIN # 4
CONNECTOR: VIEW FROM WIRE ENTRANCE

EXT & EXTL MOTORS		
PIN #	COLOR	PHASE
1	RED	A+
2	WHITE	A-
3	GREEN	B+
4	BLACK	B-

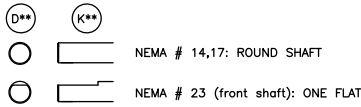

** Dimension H2 applies only to dual-shaft (D) and encoder (E) motors.
Dimension D is the same for both front and rear shafts of dual-shaft and encoder motors.
Dimensions J & K do NOT apply to rear shafts of dual-shaft and encoder motors (all rear shafts are round style).

STP-MTR-xxxxxW Motors

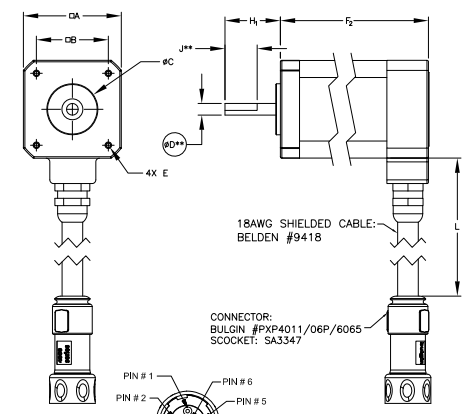

PIN # 1, PIN # 2, PIN # 3, PIN # 4, PIN # 5, PIN # 6
VIEW FROM PIN INSERT

PIN OUT CONNECTION		
PIN #	COLOR	PHASE
1	RED	A+
2	WHITE	A-
3	GREEN	B+
4	BLACK	B-
5	GROUND	GROUND
6	N/A	N/A

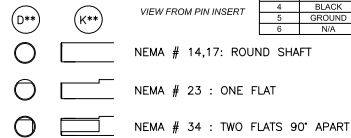

Note: Drawings and dimensions for STP-MTRD series integrated motor/drives can be found in the integrated motor/drives section of the manual

SureStep Series Dimensions & Cabling – NEMA 14, 17, and 23 Connectorized Bipolar Stepping Motors

Dimensions* (in [mm]*)	Low Torque Motors		High Torque Motors					Higher Torque Motors
	STP-MTRL-14026(x)	STP-MTRL-14034(x)	STP-MTR-17040(x)	STP-MTR-17048(x)	STP-MTR-17060(x)	STP-MTR-23055(x)	STP-MTR-23079(x)	STP-MTRH-23079(x)
A	1.39 [35.3]	1.39 [35.3]	1.67 [42.3]		2.25 [57.2]		2.25 [57.2]	
B	1.02 [25.9]	1.02 [25.9]	1.22 [31.0]		1.86 [47.2]		1.86 [47.2]	
C			Ø 0.87 [22.1]		Ø 1.50 [38.1]		Ø 1.50 [38.1]	
D**			Ø 0.20 [5.0]		Ø 0.25 [6.4]		Ø 0.25 [6.4]	
E	4-40 thread 0.15 [3.8] min depth		M3 x 0.5 thread 0.15 [3.8] min depth		Ø 0.20 [5.1] through		Ø 0.20 [5.1] through	
E2	M2.5 x 0.45 thread	M2.5 x 0.45 thread	M2.5 x 0.45 thread		M2 x 0.4 thread	4-40		4-40
F**	1.02 [25.9]	1.34 [34.0]	1.58 [40.1]	1.89 [48.0]	2.34 [59.5]	2.22 [56.4]	3.10 [78.7]	3.10 [78.7]
F2**	n/a		1.90 [48.3]	2.24 [56.9]	2.67 [67.8]	2.33 [59.1]	3.19 [81.0]	3.19 [81.0]
G1	0.375	0.375	0.375	0.375	0.411	0.906	0.906	0.906
G2	0.75	0.75	0.75	0.75	n/a	1.812	1.812	1.812
H1	0.60 [15.2]	0.60 [15.2]	0.94 [24.0]		0.81 [20.6]		0.81 [20.6]	
H2**					0.51 [13.0]			
H3***					0.40			
J**			n/a				0.59 [15.0]	
K**			n/a				0.23 [5.8]	
L					12 [305]			
Conductor	(4) #26 AWG		(4) #20 AWG, (5) #18 AWG (for W motors)					(4) #18 AWG, (5) #18 AWG (for W motors)
Connector	TE # 103653-3		Molex # 43025-0400, PXP4010/06S/6065 (for W motors)					Molex # 39-01-3042, PXP4010/06S/6065 (for W motors)
Pin	TE # 1-104505-3 (LOOSE)		Molex # 43030-0007, Socket: SA3347 (for W motors)					Molex # 39-00-0039, Socket: SA3347 (for W motors)

* mm dimensions are for reference purposes only.
** Dimension H2 applies only to dual-shaft (D) and encoder (E) motors.
Dimension D (shaft diameter) is the same for both front and rear shafts of dual-shaft (D) and encoder (E) motors.
Dimensions J & K do NOT apply to rear shafts of dual-shaft (D) and encoder (E) motors (all rear shafts are round style).
Dimension F2 applies to IP65 (W) motors only.
*** Dimension H3 applies only to "E" models with the encoder pre-mounted.



Stepping System Motors

SureStep® Motor Dimensions and Cabling

STP-MTR(x)-34xxx(X) Motors

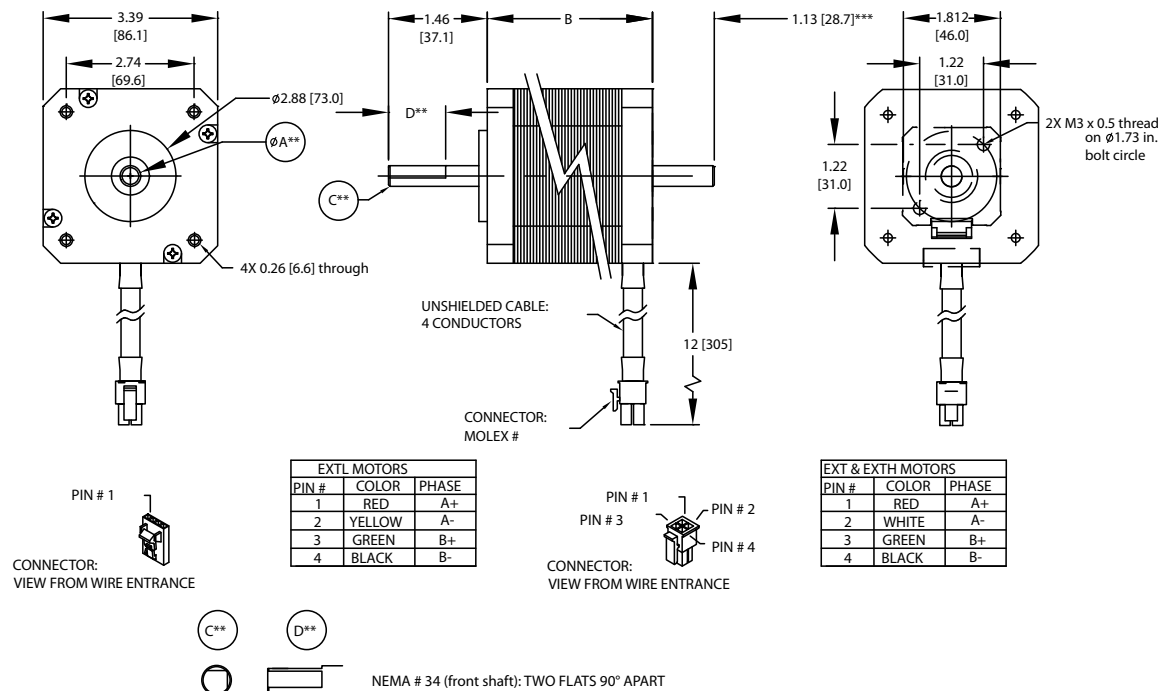

** Dimension A is the same for both front and rear shafts of dual-shaft motors.
 ** Dimensions C & D do NOT apply to rear shafts of dual-shaft motors (all rear shafts are round style).
 *** Dimension applies only to dual-shaft (D) motors.

SureStep Series Dimensions & Cabling – NEMA 34 Connectorized Bipolar Stepping Motors				
Dimensions (in [mm]*)	High Torque Motors		Higher Torque Motors	
	STP-MTR-34066(x)	STP-MTRH-34066(x)	STP-MTRH-34097(x)	STP-MTRH-34127(x)
A**	ϕ 0.50 [12.7]			
B	2.64 [67.1]	2.64 [67.1]	3.82 [97.0]	5.00 [127.0]
C**	0.98 [25.0]			
D**	0.45 [11.4]			
Conductor	(4) #20 AWG, (5) #18 AWG (for W motors)		(4) #18 AWG, (5) #18 AWG (for W motors)	
Connector	Molex # 43025-0400, PXP4010/06S/6065 (for W motors)		Molex # 39-01-3042, PXP4010/06S/6065 (for W motors)	
Pin	Molex # 43030-0007, Socket: SA3347 (for W motors)		Molex # 39-00-0039, Socket: SA3347 (for W motors)	

* mm dimensions are for reference purposes only.
 ** Dimension A (shaft diameter) is the same for both front and rear shafts of dual-shaft (D series) motors. Dimensions C & D do NOT apply to rear shafts of dual-shaft (D series) motors (all rear shafts are round style).
 *** This dimension only applies to dual-shaft (D series) motors.



Stepping System Motors

SureStep® Motor Dimensions and Cabling

STP-MTRAC-23xxx Motors

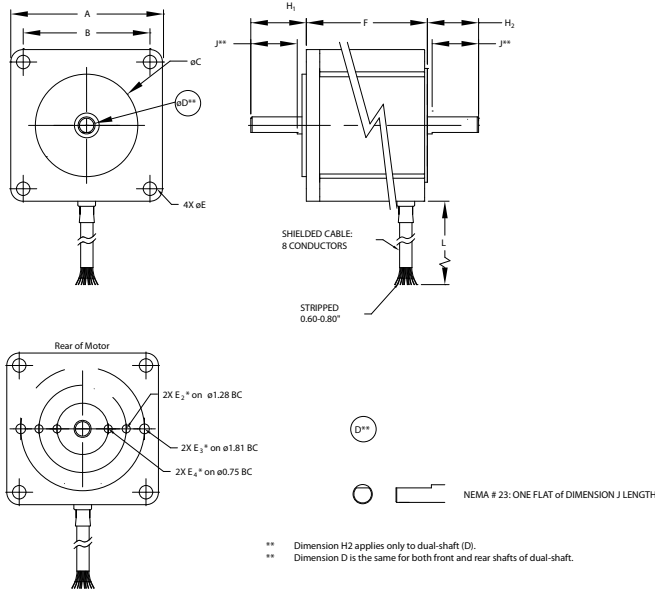

STP-MTRAC-34xxx Motors

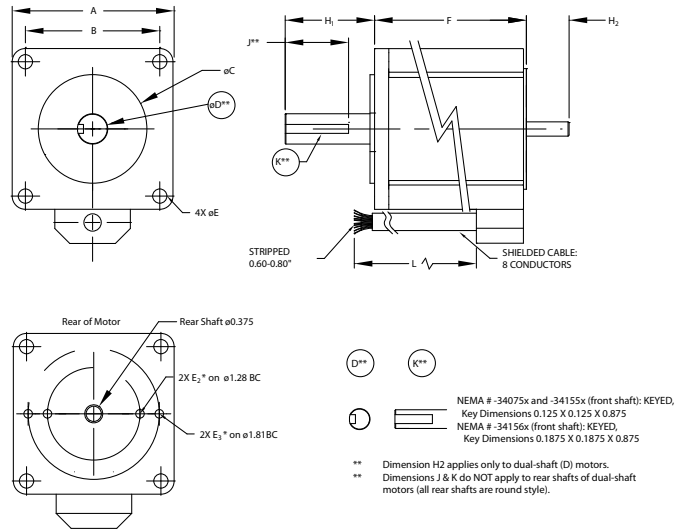

SureStep Series Dimensions & Cabling – High Voltage Bipolar Stepping Motors						
Dimensions* (in [mm])*	High Voltage High Torque					
	STP-MTRAC-23044(x)	STP-MTRAC-23055(x)	STP-MTRAC-23078(x)	STP-MTRAC-34075(x)	STP-MTRAC-34115(x)	STP-MTRAC-34156(x)
A	2.25 [57.15]	2.25 [57.15]	2.25 [57.15]	3.39 [86.1]	3.39 [86.1]	3.39 [86.1]
B	1.86 [47.24]	1.86 [47.24]	1.86 [47.24]	2.74 [69.6]	2.74 [69.6]	2.74 [69.6]
C	1.50 [38.1]	1.50 [38.1]	1.50 [38.1]	2.87 [72.9]	2.87 [72.9]	2.87 [72.9]
D**	0.25 [6.35]	0.25 [6.35]	0.25 [6.35]	0.5 [12.7]	0.5 [12.7]	0.625 [15.9]
E	0.2 [5.08]	0.2 [5.08]	0.2 [5.08]	0.22 [5.59]	0.26 [6.6]	0.22 [5.59]
E2***	2-56 thru	2-56 thru	2-56 thru	2-56 UNC Tap 0.2 Deep	2-56 UNC Tap 0.2 Deep	2-56 UNC Tap 0.2 Deep
E3***	4-40 UNC x 0.2 Deep	4-40 UNC x 0.2 Deep	4-40 UNC x 0.2 Deep	4-40 UNC Tap 0.2 Deep	4-40 UNC Tap 0.2 Deep	4-40 UNC Tap 0.2 Deep
E4***	2-56 UNC Tap 0.2 Deep	2-56 UNC Tap 0.2 Deep	2-56 UNC Tap 0.2 Deep	-	-	-
F	1.71 [43.43]	2.16 [54.86]	3.05 [77.47]	2.95 [74.93]	4.52 [114.81]	6.14 [155.96]
H1	0.81 [20.57]	0.81 [20.57]	0.81 [20.57]	1.25 [31.75]	1.25 [31.75]	1.25 [31.75]
H2***	0.63 [16.0]	0.63 [16.0]	0.63 [16.0]	1.12 [28.45]	1.12 [28.45]	1.12 [28.45]
J	0.60 [15.24]	0.60 [15.24]	0.60 [15.24]	0.87 [22.1]	0.87 [22.1]	0.87 [22.1]
L	120 [3048]	120 [3048]	120 [3048]	120 [3048]	120 [3048]	120 [3048]

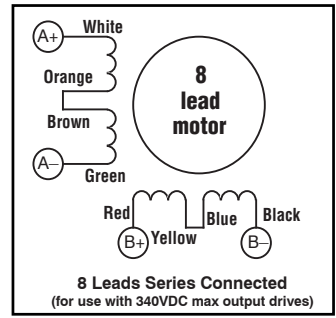

STP-MTRAC-230xx(x), 34156(x) Motor Wiring

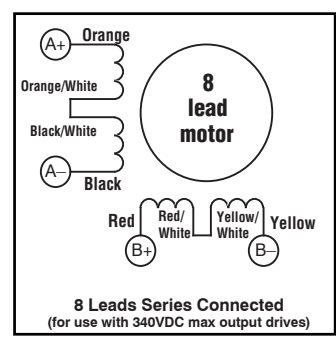

STP-MTRAC-34075(x), 34115(x) Motor Wiring

* mm dimensions are for reference purposes only.
** Dimension D (shaft diameter) is the same for both front and rear shafts of NEMA 23 dual-shaft motors. See diagrams for NEMA 34.
*** Dimension applies only to dual-shaft (D) motors.



Stepping System Motors

STP-MTRAC-42xxx Motors

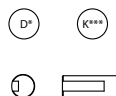
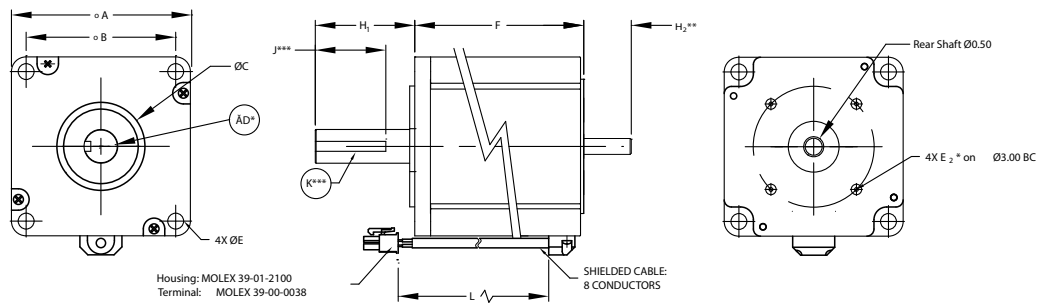

NEMA # 42 (front shaft): KEYED, Key Dimensions 0.188 X 0.188 X 1.377

* Dimension D applies only to the front shaft.
 ** Dimension H2 applies only to dual-shaft (D) motors.
 *** Dimensions J & Key do NOT apply to rear shafts of dual-shaft motors

(all rear shafts are round style).

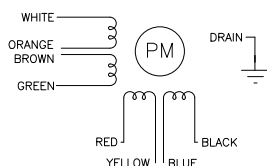

Uni-polar

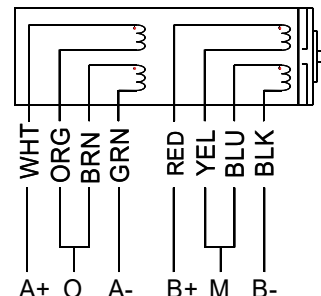

Bi-polar series

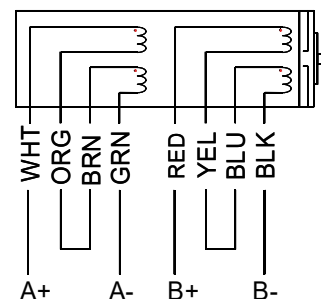

Bi-polar parallel

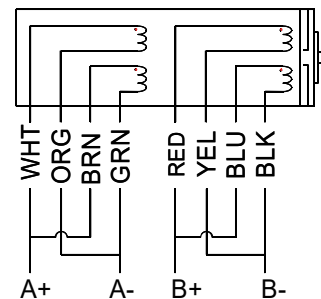

SureStep Series Dimensions & Cabling – Higher Voltage Bipolar Stepping Motors												
Dimensions* (in [mm]*)	Higher Voltage High Torque											
	<u>STP-MTRAC-42100</u>	<u>STP-MTRACH-42100</u>	<u>STP-MTRAC-42151</u>	<u>STP-MTRACH-42151</u>	<u>STP-MTRAC-42202</u>	<u>STP-MTRACH-42202</u>	<u>STP-MTRAC-42100D</u>	<u>STP-MTRACH-42100D</u>	<u>STP-MTRAC-42151D</u>	<u>STP-MTRACH-42151D</u>	<u>STP-MTRAC-42202D</u>	<u>STP-MTRACH-42202D</u>
A	4.33 [110]	4.33 [110]	4.33 [110]	4.33 [110]	4.33 [110]	4.33 [110]	4.33 [110]	4.33 [110]	4.33 [110]	4.33 [110]	4.33 [110]	4.33 [110]
B	3.50 [88.9]	3.50 [88.9]	3.50 [88.9]	3.50 [88.9]	3.50 [88.9]	3.50 [88.9]	3.50 [88.9]	3.50 [88.9]	3.50 [88.9]	3.50 [88.9]	3.50 [88.9]	3.50 [88.9]
C	2.19 [55.6]	2.19 [55.6]	2.19 [55.6]	2.19 [55.6]	2.19 [55.6]	2.19 [55.6]	2.19 [55.6]	2.19 [55.6]	2.19 [55.6]	2.19 [55.6]	2.19 [55.6]	2.19 [55.6]
D**	0.75 [19.05]	0.75 [19.05]	0.75 [19.05]	0.75 [19.05]	0.75 [19.05]	0.75 [19.05]	0.75 [19.05]	0.75 [19.05]	0.75 [19.05]	0.75 [19.05]	0.75 [19.05]	0.75 [19.05]
E	0.327 [8.31]	0.327 [8.31]	0.327 [8.31]	0.327 [8.31]	0.327 [8.31]	0.327 [8.31]	0.327 [8.31]	0.327 [8.31]	0.327 [8.31]	0.327 [8.31]	0.327 [8.31]	0.327 [8.31]
E2	n/a	n/a	n/a	n/a	4-40 UNC Tap 0.2 Deep	4-40 UNC Tap 0.2 Deep	4-40 UNC Tap 0.2 Deep	4-40 UNC Tap 0.2 Deep	4-40 UNC Tap 0.2 Deep	4-40 UNC Tap 0.2 Deep	4-40 UNC Tap 0.2 Deep	4-40 UNC Tap 0.2 Deep
F	3.88	5.94	7.91	3.88***	5.94***	7.91***						
H1	2.19 [55.6]	2.19 [55.6]	2.19 [55.6]	2.19 [55.6]	2.19 [55.6]	2.19 [55.6]	2.19 [55.6]	2.19 [55.6]	2.19 [55.6]	2.19 [55.6]	2.19 [55.6]	2.19 [55.6]
H2	n/a	n/a	n/a	1.12 [28.4]	1.12 [28.4]	1.12 [28.4]	1.12 [28.4]	1.12 [28.4]	1.12 [28.4]	1.12 [28.4]	1.12 [28.4]	1.12 [28.4]
J**	1.37 [34.8]	1.37 [34.8]	1.37 [34.8]	1.37 [34.8]	1.37 [34.8]	1.37 [34.8]	1.37 [34.8]	1.37 [34.8]	1.37 [34.8]	1.37 [34.8]	1.37 [34.8]	1.37 [34.8]
L	12 [305]											

* mm dimensions are for reference purposes only.

** Dimension D (shaft diameter), J, and Key do not apply to rear shafts of dual-shaft motors.

*** For encoder mounting the required STP-MTRA-42ENC bracket will add 0.13 inches [3.2 mm] to the length of the motor.



Stepping System Accessories

SureStep® Microstepping Drives Accessories

Braking Accessories

As a load rapidly decelerates from a high speed, much of the kinetic energy of that load is transferred back to the motor. This energy is then pushed back to the drive and power supply, resulting in increased system voltage. If there is enough overhauling load on the motor, the DC voltage will go above the drive and/or power supply limits. In general, the more torque the motor is capable of producing then the more energy it can push back into the drive.

When using a regulated/switching power supply, this can trip the overvoltage protection of the power supply or drive, and cause it to shut down.

To solve this problem, AutomationDirect offers a regeneration clamp as an optional accessory. The regen clamp has a built-in 50W braking resistor. The STP-DRVA-RC-050A does not have the ability to use an external resistor.



Regeneration Clamp [STP-DRVA-RC-050A](#)

Regeneration Clamp Features

[STP-DRVA-RC-050A](#)

- Built-in 50W power resistor for more continuous current handling
- Mounted on a heat sink
- Voltage range: 24–80 VDC; no user adjustments required
- Power: 50W continuous; 800W peak
- Indicators (LED):
Green = power supply voltage is present
Red = clamp is operating (usually when stepper is decelerating)
- Protection: The external power supply is internally connected to an “Input Diode” in the regen clamp that protects the power supply from high regeneration voltages. This diode protects the system from connecting the power supply in reverse. If the clamp circuit fails, the diode will continue to protect the power supply from over-voltage.
- Three drive connections, 7A max per channel, 15A total output current
- Removable terminal blocks (replacement kit STP-CON-4)
- Uses 18-20 AWG wire for connections

SureStep Damper

A step motor inertia damper can smooth out steps in a typical step motor resulting in a quieter and smoother motion when rotating between steps. Reducing the resonance and possible micro oscillations when moving from step to step is the main purpose of a “hockey puck” style damper, but it can also be used as a hand wheel to directly rotate the position of the rotor when power is removed from the motor. The damper is a properly sized machined piece of aluminum encased in plastic. It is sized and weighted for general damping of the respective frame size motor.



Damper

Sure Step Series Specifications – Microstepping Drives Optional Accessories			
Part Number	Price	Description	Drawing
STP-DRVA-RC-050A *	\$61.00	Regen Clamp: 50W, for DC input stepper and servo drives, enclosed	PDF
STP-MTRA-17DMP	\$15.00	SureStep damper, metal body. For use with NEMA 17 stepper motors with 5mm shafts. Mounting set screw included.	PDF
STP-MTRA-23DMP	\$34.50	SureStep damper, metal body. For use with NEMA 23 stepper motors with 1/4 inch shafts. Mounting set screw included.	PDF

* Do not use the regeneration clamp in an atmosphere containing corrosive gases.



Stepping System Accessories

SureStep® Microstepping Drives Accessories

Dimensions = in [mm]

STP-DRVA-RC-050A

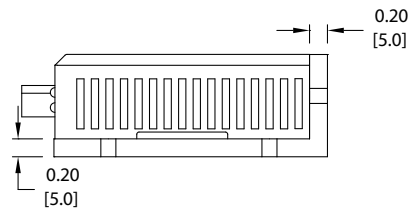
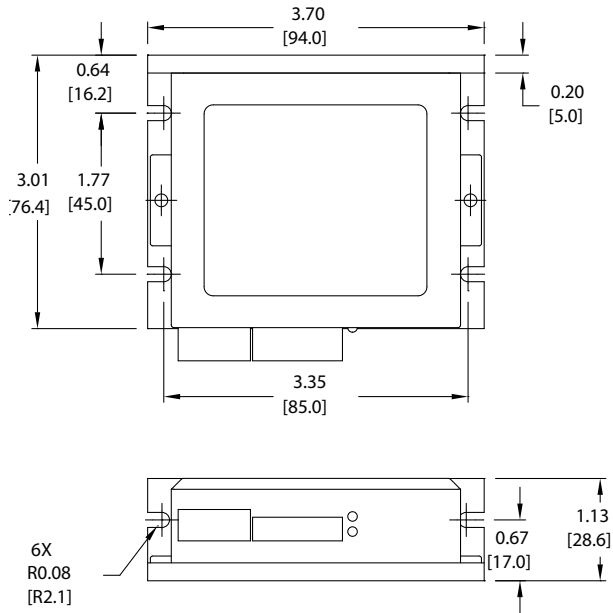



Stepping System Accessories

SureStep® Microstepping Drives Accessories

USB to RS-485 Adapter

The STP-USB485-4W is a USB to RS-232/RS-485 converter that can be used in 2-wire or 4-wire serial networks. Serial communication can be wired up via the 9-pin D-sub connector or through the 6-screw terminals.

The STP-USB485-4W can be set for several different configurations. These modes are set up by the 4 DIP switches on the outside of the case (RS-232/RS-485, full/half duplex) and by the 7 jumpers located inside the case (termination/bias resistors).

SureStep Advanced Drives communicate via RS-232 (for control and for configuration via SureMotion Pro).

The Advanced Integrated motor/drives use RS-485. While the Advanced Integrated motor/drives can be wired for either 2- or 4-wire networks, 4-wire is require for use with SureMotion Pro due to the Firmware Download utility and the Status Monitor Screen.

Depending on the host controller's RS-485 implementation, either 2- or 4-wire RS-485 can be used for control. All RS-485 PLCs that have 2-wire capability (Productivity, BRX, Click, DirectLogic, etc.) can control the Advanced Integrated steppers.



SureStep PC Adapter - STP-USB485-4W	
Price	\$130.00
Drawing	PDF
Communications	2-wire RS-232 2- or 4-wire RS-485
Configure With	Internal jumpers and external DIP switches
Compatible Cables	STP-232RJ11-CBL STP-485DB9-CBL-2 USB

Dimensions = in [mm]

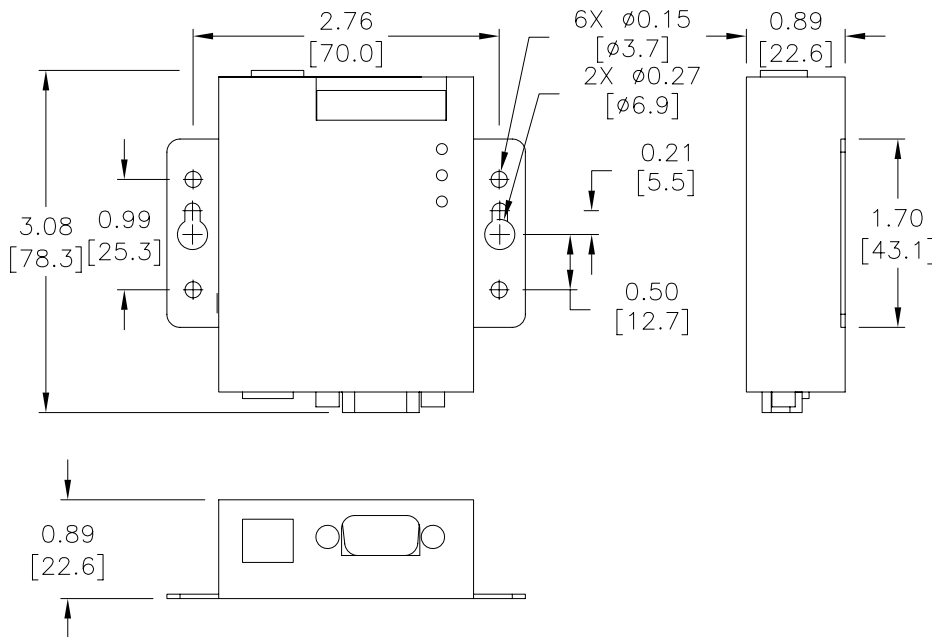



Stepping System Accessories

SureStep® Stepping System Encoders

Replacement Encoders

The [STP-MTRA-ENC1](#) is a replacement for the encoder that comes standard with the [STP-MTRD-17038E](#), [STP-MTRD-23042E](#), and [STP-MTRD-23065E](#) integrated motor/drives. Note that the encoder included with (E) model advanced integrated motor/drives is internal and cannot be replaced.

The [AMT112Q-V](#) is a replacement for the encoder that comes standard with the [STP-MTR\(x\)-xxxxE](#) stand alone step motors.

Installation tool and mounting hardware is included with all replacement encoders. For more information and details on how to wire the replacement encoders, please see the SureStep User Manual.

Optional Encoders

Optional encoders can be purchased separately for standard integrated motor/drives and standalone dual-shaft motors in all NEMA 14, 17, and 23 sizes, and also for [STP-MTRAC-34xxxD](#) motors (currently not available for [STP-MTRx-34xxxD](#) motors). All (D) model (dual-shaft) step motors come with pre-drilled holes in the rear end cap for easy encoder mounting. Pre-installed encoders on standalone dual-shaft motors and standard integrated motor/drives can be retrofitted with an appropriate optional encoder if desired. Please see the chart on the following page for encoder compatibility.

Features:

- Fixed resolutions include 400ppr or 1000ppr
- Configurable models have up to 4096ppr (default = 400ppr)
- Choose line driver or push-pull (totem) output signals



STP-MTRA-ENC2



AMT112Q-V



STP-MTRA-ENC11

Sure Step Series Specifications – Encoders			
Part Number	Price	Description	Drawing
STP-MTRA-ENC1	\$67.00	SureStep incremental (quadrature) modular encoder, 5VDC, line driver (differential) output, 1000 ppr. For use with SureStep stepper motors with 5mm rear shaft. Installation tool and mounting hardware included.	PDF
STP-MTRA-ENC2	\$67.00	SureStep incremental (quadrature) modular encoder, 5VDC, Push-pull (totem) output, 1000 ppr. For use with SureStep stepper motors with 5mm rear shaft. Installation tool and mounting hardware included.	PDF
STP-MTRA-ENC3	\$69.00	SureStep incremental (quadrature) modular encoder, 5VDC, line driver (differential) output, 400 ppr. For use with SureStep stepper motors with 5mm rear shaft. Installation tool and mounting hardware included.	PDF
STP-MTRA-ENC4	\$58.00	SureStep incremental (quadrature) modular encoder, 5VDC, Push-pull (totem) output, 400 ppr. For use with SureStep stepper motors with 5mm rear shaft. Installation tool and mounting hardware included.	PDF
STP-MTRA-ENC5	\$80.00	SureStep incremental (quadrature) modular encoder, 5VDC, line driver (differential) output, 1000 ppr. For use with SureStep stepper motors with 1/4 inch rear shaft. Installation tool and mounting hardware included.	PDF
STP-MTRA-ENC6	\$67.00	SureStep incremental (quadrature) modular encoder, 5VDC, Push-pull (totem) output, 1000 ppr. For use with SureStep stepper motors with 1/4 inch rear shaft. Installation tool and mounting hardware included.	PDF
STP-MTRA-ENC7	\$69.00	SureStep incremental (quadrature) modular encoder, 5VDC, line driver (differential) output, 400 ppr. For use with SureStep stepper motors with 1/4 inch rear shaft. Installation tool and mounting hardware included.	PDF
STP-MTRA-ENC8	\$58.00	SureStep incremental (quadrature) modular encoder, 5VDC, Push-pull (totem) output, 400 ppr. For use with SureStep stepper motors with 1/4 inch rear shaft. Installation tool and mounting hardware included.	PDF
STP-MTRA-ENC11	\$72.00	SureStep incremental (quadrature) modular encoder, 5 VDC, line driver (differential) output, 1000 ppr. For use with SureStep stepper motors with 3/8in rear shaft. Installation hardware included. Requires STP-CBL-EAxx cable.	PDF
STP-MTRA-ENC12	\$60.00	SureStep incremental (quadrature) modular encoder, 5 VDC, push-pull (totem) output, 1000 ppr. For use with SureStep stepper motors with 3/8in rear shaft. Installation hardware included. Requires STP-CBL-EDxx cable.	PDF
STP-MTRA-ENC13	\$61.00	SureStep incremental (quadrature) modular encoder, 5 VDC, line driver (differential) output, 400 ppr. For use with SureStep stepper motors with 3/8in rear shaft. Installation hardware included. Requires STP-CBL-EAxx cable.	PDF
STP-MTRA-ENC14	\$52.00	SureStep incremental (quadrature) modular encoder, 5 VDC, push-pull (totem) output, 400 ppr. For use with SureStep stepper motors with 3/8in rear shaft. Installation hardware included. Requires STP-CBL-EDxx cable.	PDF



Stepping System Accessories

SureStep® Stepping System Encoders

Sure Step Series Encoder Compatibility						
Part Number	PPR	Bore Diameter	Output Type	Encoder Cable	PLC Compatibility	Motor Compatibility
<u>STP-MTRA-ENC1</u>	1000	5mm	Line Driver	STP-CBL-EAxx	P2-HSI, P3-HSI, BRX*, CLICK C0-1xDxE-D*	STP-MTRx-14xxxD STP-MTRx-14xxxE STP-MTRx-17xxxD STP-MTRx-17xxxE Standard STP-MTRD-xxxxE
<u>STP-MTRA-ENC2</u>			Push-pull (totem)	STP-CBL-EDxx	BRX*, CLICK C0-1xDxE-D*	
<u>STP-MTRA-ENC3</u>	400		Line Driver	STP-CBL-EAxx	P2-HSI, P3-HSI, BRX*, CLICK C0-1xDxE-D*	
<u>STP-MTRA-ENC4</u>			Push-pull (totem)	STP-CBL-EDxx	BRX*, CLICK C0-1xDxE-D*	
<u>STP-MTRA-ENC5</u>	1000	0.25 inch	Line Driver	STP-CBL-EAxx	P2-HSI, P3-HSI, BRX*, CLICK C0-1xDxE-D*	STP-MTRx-23xxxD STP-MTRx-23xxxE STP-MTRAC-23xxxD
<u>STP-MTRA-ENC6</u>			Push-pull (totem)	STP-CBL-EDxx	BRX*, CLICK C0-1xDxE-D*	
<u>STP-MTRA-ENC7</u>	400		Line Driver	STP-CBL-EAxx	P2-HSI, P3-HSI, BRX*, CLICK C0-1xDxE-D*	
<u>STP-MTRA-ENC8</u>			Push-pull (totem)	STP-CBL-EDxx	BRX*, CLICK C0-1xDxE-D*	
<u>STP-MTRA-ENC11</u>	1000	0.375 inch	Line Driver	STP-CBL-EAxx	P2-HSI, P3-HSI, BRX*, CLICK C0-1xDxE-D*	STP-MTRAC-34xxxD
<u>STP-MTRA-ENC12</u>			Push-pull (totem)	STP-CBL-EDxx	BRX*, CLICK C0-1xDxE-D*	
<u>STP-MTRA-ENC13</u>	400		Line Driver	STP-CBL-EAxx	P2-HSI, P3-HSI, BRX*, CLICK C0-1xDxE-D*	
<u>STP-MTRA-ENC14</u>			Push-pull (totem)	STP-CBL-EDxx	BRX*, CLICK C0-1xDxE-D*	

* Requires FC-ISO-C

SureStep® Stepping System Encoders

Dimensions = in [mm]

STP-MTRA-ENC1, 3, 5, 7

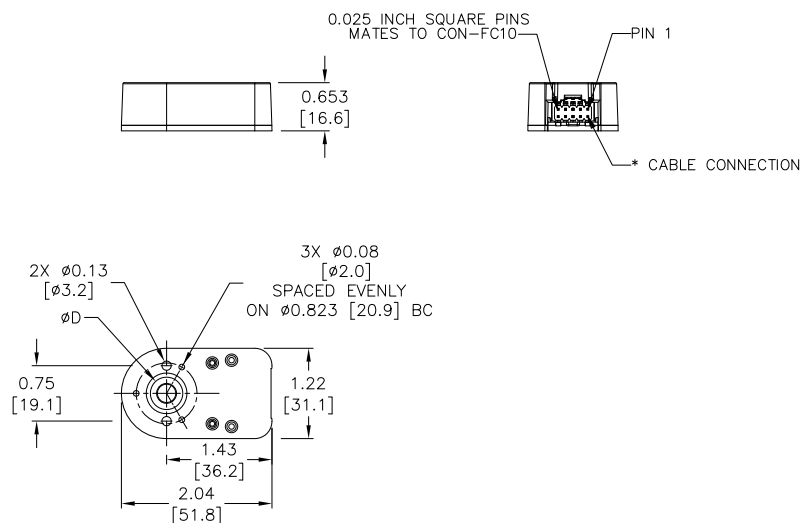

Bolt Hole Circles for Mounting	
Encoder	Holes
ENC1, ENC2, ENC3, ENC4, ENC5, ENC6, ENC7, ENC8	2 holes @ 19.05mm (.75") 3 holes @ 20.9mm (.823")

STP-MTRA-ENC2, 4, 6, 8

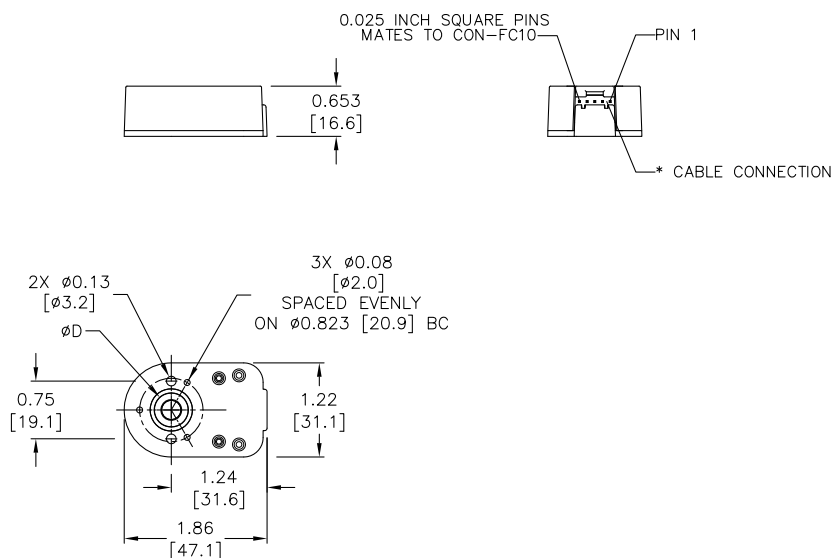

SureStep® Stepping System Encoders

Dimensions = in [mm]

STP-MTRA-ENC11, 13

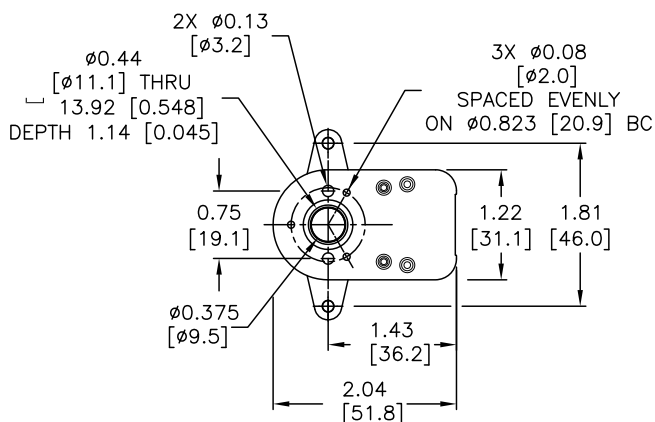
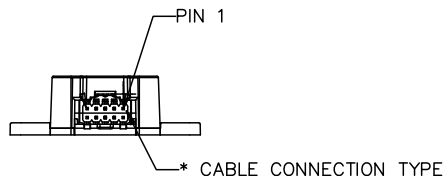
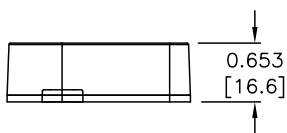

Bolt Hole Circles for Mounting	
Encoder	Holes
ENC11, ENC12, ENC13, ENC14	2 holes @ 19.05mm (.75")
	3 holes @ 20.9mm (.823")
	2 holes @ 46.02mm (1.812")

STP-MTRA-ENC12, 14

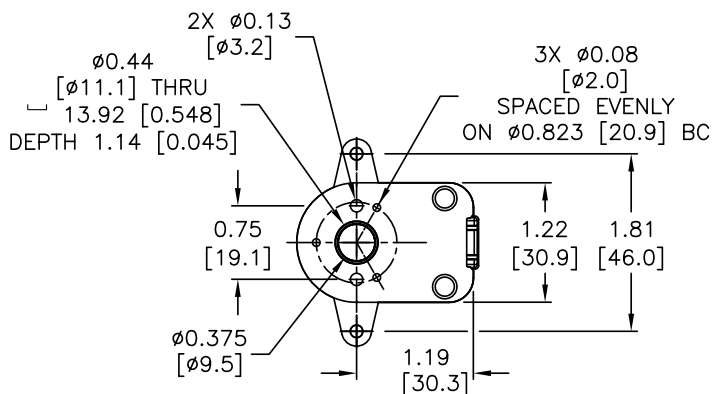
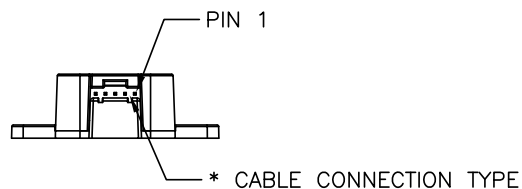
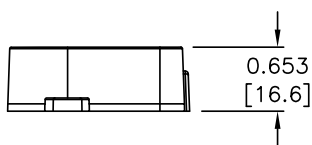



Stepping System Cables

SureStep® Cables

SureStep Series – Stepping System Cables						
Cable	Price	Purpose	Length	Use With	Cable End Connectors	Drawing
STP-EXT-006	\$13.00	motor to drive extension	6 ft	STP-MTR-xxxx(x)	pigtail / Molex 43020-0401 connector	PDF
STP-EXT-010	\$14.50		10 ft			PDF
STP-EXT-020	\$18.50		20 ft			PDF
STP-EXTH-006	\$26.50		6 ft	STP-MTRH-xxxx(x)	pigtail / Molex 39-01-2041 connector	PDF
STP-EXTH-010	\$31.50		10 ft			PDF
STP-EXTH-020	\$38.00		20 ft			PDF
STP-EXTHW-006	\$50.00		6 ft	STP-MTRHW-xxxx(x)	Bulgin # PXP4011/06P/6065	PDF
STP-EXTHW-010	\$55.00		10 ft			PDF
STP-EXTHW-020	\$71.00		20 ft			PDF
STP-EXTL-006	\$11.50		6 ft	STP-MTRL-xxxx(x)	pigtail / Molex 105308-22004 connector	PDF
STP-EXTL-010	\$14.50		10 ft			PDF
STP-EXTL-020	\$18.00		20 ft			PDF
STP-EXTW-006	\$50.00	6 ft	STP-MTRW-xxxx(x)	Bulgin # PXP4011/06P/6065	PDF	
STP-EXTW-010	\$55.00	10 ft			PDF	
STP-EXTW-020	\$71.00	20 ft			PDF	
STP-EXT42-006	\$26.00	motor to drive extension	6 ft	STP-MTRAC-42xxxx	10-pin / pigtail	PDF
STP-EXT42-010	\$31.00		10 ft			PDF
STP-EXT42-020	\$44.50		20 ft			PDF
STP-EXT42H-006	\$26.00		6 ft	STP-MTRACH-42xxxx		PDF
STP-EXT42H-010	\$31.00		10 ft			PDF
STP-EXT42H-020	\$44.50		20 ft			PDF
STP-232RJ11-CBL*	\$11.00	programming/communication	10 ft	STP-DRV-4850, STP-DRV-80100	DB9 female / RJ11(6P4C)	PDF
STP-232HD15-CBL-2**	\$17.00	communication	6.6 ft	STP-DRV-4850, STP-DRV-80100 DL06, D2-250-1, D2-260	HD 15-pin male / RJ12 6-pin plug	n/a
STP-232RJ12-CBL-2**	\$10.50	communication	6.6 ft	STP-DRV-4850, STP-DRV-80100 DL05, CLICK	RJ11 (6P4C) plug / RJ12 6-pin plug	n/a
STP-CBL-CA6	\$19.00	control cable	6 ft	STP-MTRD-17038 STP-MTRD-17038E	11-pin / pigtail	PDF
STP-CBL-CA10	\$23.00	control cable	10 ft		11-pin / pigtail	PDF
STP-CBL-CA20	\$33.50	control cable	20 ft		11-pin / pigtail	PDF
STP-CBL-EA6	\$19.00	encoder cable	6 ft	STP-MTRD-xxxxE STP-MTRA-ENC1, STP-MTRA-ENC3 STP-MTRA-ENC5, STP-MTRA-ENC7 STP-MTRA-ENC11, STP-MTRA-ENC13 (for line driver encoders)	10-pin / pigtail	PDF
STP-CBL-EA10	\$23.00	encoder cable	10 ft		10-pin / pigtail	PDF
STP-CBL-EA20	\$33.50	encoder cable	20 ft		10-pin / pigtail	PDF
STP-CBL-EB3	\$31.00	encoder cable	3 ft	AMT112Q-V AMT112S-V (for both line driver and push-pull (totem) encoders)	17-pin / pigtail	PDF
STP-CBL-EB6	\$48.50	encoder cable	6 ft		17-pin / pigtail	PDF
STP-CBL-EB10	\$72.00	encoder cable	10 ft		17-pin / pigtail	PDF
STP-CBL-EB20	\$133.00	encoder cable	20 ft		17-pin / pigtail	PDF
STP-CBL-ED6	\$19.00	encoder cable	6 ft	STP-MTRA-ENC2, STP-MTRA-ENC4 STP-MTRA-ENC6, STP-MTRA-ENC8 STP-MTRA-ENC12, STP-MTRA-ENC14 (for push-pull (totem) encoders)	5-pin / pigtail	PDF
STP-CBL-ED10	\$23.50	encoder cable	10 ft		5-pin / pigtail	PDF
STP-CBL-ED20	\$34.50	encoder cable	20 ft		5-pin / pigtail	PDF
STP-CON-1	\$18.00	replacement connector kit	n/a	STP-DRV-4845 & -6575	-	n/a
STP-CON-2	\$18.00	replacement connector kit	n/a	STP-DRV-4850 & 80100	-	n/a

* Programming/communication cable [STP-232RJ11-CBL](#) is available for spare or replacement purposes.
(One cable is included with each software programmable drive.)

** Refer to the [ZIPLinks Wiring Solutions](#) section for complete information regarding cables [STP-232HD15-CBL-2](#) and [STP-232RJ12-CBL-2](#).

SureStep® Cables, *continued*

SureStep Series – Stepping System Cables						
Cable	Price	Purpose	Length	Use With	Cable End Connectors	Drawing
STP-CON-3	\$36.50	replacement connector kit	n/a	STP-MTRD-xxxxR	-	n/a
STP-CON-4	\$18.00	replacement connector kit	n/a	STP-DRVA-RC-050A	-	n/a
STP-CON-5	\$18.00	replacement connector kit	n/a	STP-DRV-4830	-	PDF
STP-CON-6	\$23.50	replacement connector kit	n/a	STP-DRVAC-24025	-	n/a
STP-485DB9-CBL-2	\$42.00	4-wire programming cable	6.5 ft	STP-MTRD-xxxxR	DB9 / Phoenix 5-conductor plug	PDF

STP-EXT(x)-0xx Extension Cable Wiring Diagram

EXT & EXTH CABLES

PIN#	COLOR
1	RED
2	WHITE
3	GREEN
4	BLACK

EXTL CABLES

PIN#	COLOR
1	RED
2	WHITE
3	GREEN
4	BLACK

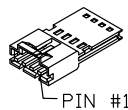
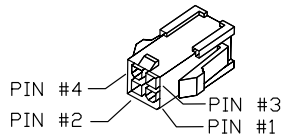

CONNECTORS:

EXT: Molex #43020-0401
 EXTH: Molex #39-01-2041
 EXTL: TE #103653-3

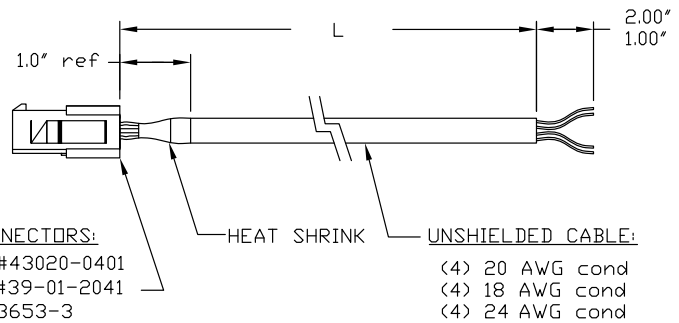

STP-EXTW-0xx and STP-EXTHW-0xx Extension Cable Wiring Diagram

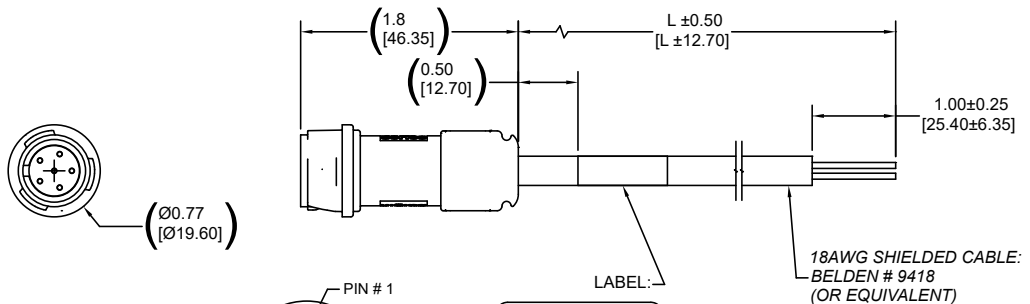

PIN OUT CONNECTION		
PIN #	COLOR	PHASE
1	RED	A+
2	WHITE	A-
3	GREEN	B+
4	BLACK	B-
5	GROUND	GROUND
6	N/A	N/A

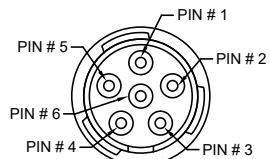

VIEW FROM PIN CONNECTION
 Connector: Bulgin # PXP4011/06P/6065

LABEL:
 STP-EXTW-0XX
 or
 STP-EXTHW-0XX



Stepping System Cables

SureStep® Cables, continued

STP-232RJ11-CBL Programming Cable Wiring Diagram

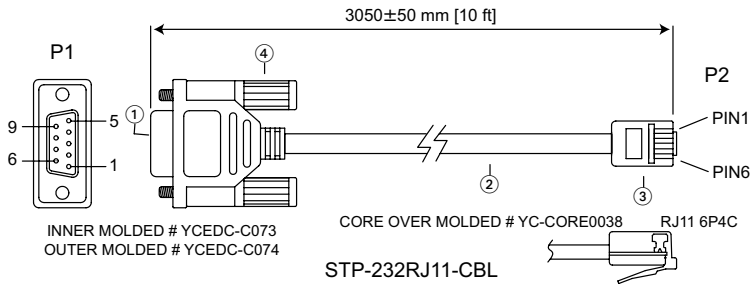

WIRE CONNECTION

(DB9) P1		P2 (RJ11 6P4C)
2	RX	TX
3	TX	RX
4	nc	nc
5	GND	GND

①	DB 9P FEMALE CONNECTOR SHELL: FRONT NICKEL BACK TIN INSULATOR COLOR: BLACK
②	CABLE: CAT-5 UTP 24AWG (7/0.203BA*2PR) 100MHz COLOR: BLACK OD: 4.5mm
③	RJ11 6P4C PLATED GOLD 3U"
④	SCREW: #4-40UNC PD40*175TNP COLOR: BLACK

STP-485DB9-CBL-2 4-wire Programming Cable Wiring Diagram

CONNECTION CHART				
DB-9 CONN PIN	DB9 SIGNAL	WIRE COLOR	PHOENIX PIN	PHOENIX SIGNAL
2	TX+	RED	5	RX+
1	TX-	ORANGE	4	RX-
3	RX+	BLACK	3	TX+
4	RX-	BROWN	2	TX-
5	GND	YELLOW	1	GND
METAL HOUSING	SHIELD	SHIELD	N/C	N/C

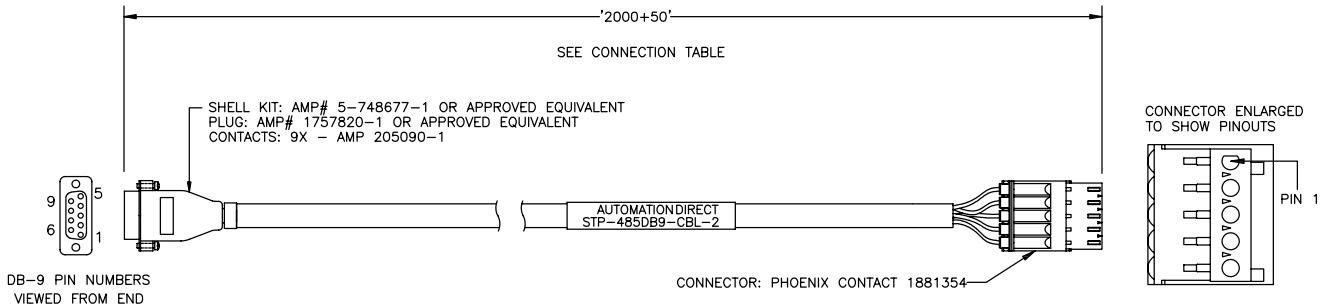

SureStep® Cables, continued

STP-CBL-CAXx Control Cable Wiring Diagram

C 1		
PIN NO.	SIGNAL	WIRE COLOR
1	STEP+	ORANGE
2	STEP-	BROWN
3	DIR+	YELLOW
4	DIR-	GREEN
5	EN+	BLUE
6	EN-	TAN
7	OUT+	GRAY
8	OUT-	WHITE
9	N.C.	PINK
10	V-	BLACK
11	V+	RED
12	N/C	PURPLE - CUT

Note: For Rev A of this cable, STEP+ is Grey/Pink and EN- is Red/Blue

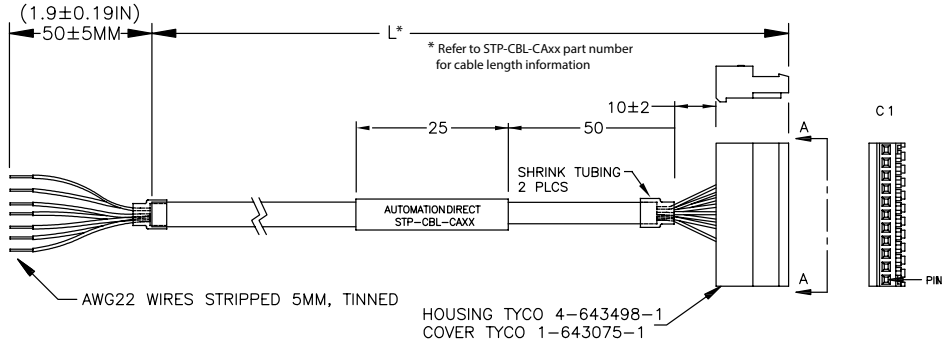

STP-CBL-EAXx Encoder Cable Wiring Diagram

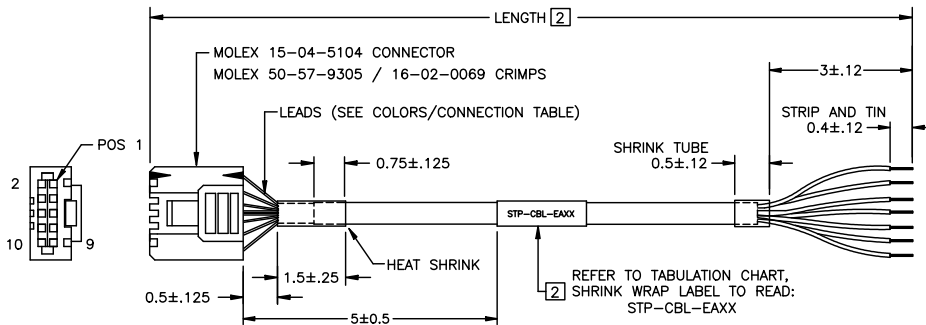

CONN	CONNECTION TABLE		
PIN	LEAD COLOR	SIGNAL	
2	GREEN/WHITE	GROUND	TWISTED PAIR
7	GREEN	POWER+	
3	ORANGE/WHITE	Z-	TWISTED PAIR
4	ORANGE	Z+	
5	BLUE/WHITE	A-	TWISTED PAIR
6	BLUE	A+	
9	BROWN/WHITE	B-	TWISTED PAIR
10	BROWN	B+	
1	N/C	N/A	NO CONNECTION
8	N/C	N/A	

WIRE: 24AWG, CABLE: UL2464.

STP-CBL-EBxx Encoder Cable Wiring Diagram

- NOTE:
- Case_GND is connected internally to GND (BLACK/RED)
 - Ground connected internally to cable shielding-customer ref. only
 - Tolerance: ± 0.2" [5] unless otherwise specified
 - All materials must be ROHS compliant

TABLE INFORMATION	
CABLE NUMBER	CABLE LENGTH L
STP-CBL-EB3	3 Feet
STP-CBL-EB6	6 Feet
STP-CBL-EB10	10 Feet
STP-CBL-EB20	20 Feet

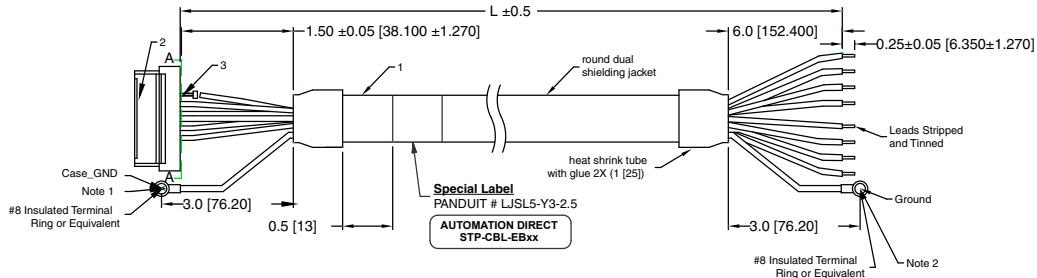

Connector Pinout			
#	Function	Primary Color	Stripe Color
4	GND	Black	Red
6	+5V	Red	Black
8	B+	Green	Black
9	B-	Black	Green
10	A+	White	Black
11	A-	Black	White
12	Z+	Blue	Black
13	Z-	Black	Blue

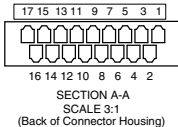

PARTS LIST			
#	PART	DESCRIPTION	QTY
1	CABLE	3M # 3600B/14	1
2	CONNECTOR	JAE # FI-W175	1
3	CRIMP PINS	JAE # FI-C3-A1-15000	8



Stepping System Accessories

AMT Series Stepping System Encoders

AMT Series Encoders, continued			
Part Number	Price	Description	Drawing
AMT132S-V	\$34.50	CUI Devices incremental (quadrature) modular encoder, 5 VDC, radial, push-pull (totem) output, configurable up to 4096 ppr. For use with NEMA 34 and 42 dual shaft motors.	PDF
AMT132Q-V	\$38.50	CUI Devices incremental (quadrature) modular encoder, 5 VDC, radial, line driver (differential) output, configurable up to 4096 ppr. For use with NEMA 34 and 42 dual shaft motors.	PDF
AMT332S-V	\$38.50	CUI Devices incremental (quadrature)/commutation modular encoder, 5 VDC, radial, push-pull (totem) encoder output, configurable up to 4096 ppr, push-pull (totem) commutation output. For use with NEMA 34 and 42 dual shaft motors.	PDF
AMT332D-V	\$42.50	CUI Devices incremental (quadrature)/commutation modular encoder, 5 VDC, radial, line driver (differential) encoder output, configurable up to 4096 ppr, line driver (differential) commutation output. For use with NEMA 34 and 42 dual shaft motors.	PDF

See Accessories section for configuration and signal cables.
 CUI Devices Datasheets provide detailed encoder specifications. These datasheets can be found on each encoder's web page at www.automationdirect.com.



AMT132S-V



AMT332S-V

AMT Series Encoder Accessories		
Part Number	Price	Description
CUI-KIT-1	\$6.50	CUI Devices encoder accessory kit, replacement. For use with CUI Devices AMT102 encoders. Includes (1) AMT102 base, (1) AMT102 wide base, and (1) AMT10 sleeve kit (9 sleeves sized from 2-8mm).
CUI-KIT-2	\$6.50	CUI Devices encoder accessory kit, replacement. For use with CUI Devices AMT103 encoders. Includes (1) AMT standard base, (1) AMT standard wide base, and (1) AMT10 sleeve kit (9 sleeves sized from 2-8mm).
CUI-KIT-3	\$6.50	CUI Devices encoder accessory kit, replacement. For use with CUI Devices AMT11, AMT21, and AMT31 encoders. Includes (1) AMT standard base, (1) AMT standard wide base, and (1) AMT standard sleeve kit (9 sleeves sized from 2-8mm).
CUI-KIT-4	\$6.50	CUI Devices encoder sleeve kit, replacement. For use with CUI Devices AMT13 and AMT33 encoders. Includes (8) sleeves sized from 9-14mm.
STP-MTRA-SCRWKT-1	\$5.50	SureStep encoder mounting screw kit, for use with all stepper encoders.



CUI-KIT-1



CUI-KIT-2



CUI-KIT-3



CUI-KIT-4



STP-MTRA-SCRWKT-1