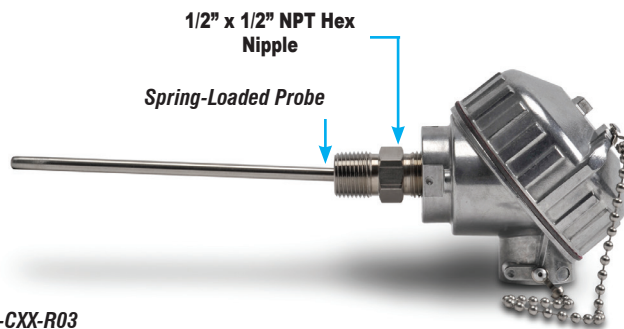

pro^{sense}® RTD Spring-Loaded Probes with Connection Head

RTD1-CXX-03

RTD1-CXX-R03
Replacement Probe

Overview

- Probe
 - Spring-loaded for positive tip contact in thermowells
 - 100 ohm platinum RTD 3-wire element
 - Class A accuracy
 - 1/4" diameter, 316 SS sheath to protect against harsh environments
 - RTD element encased in alumina powder insulation provides excellent vibration dampening and heat transfer
 - 4", 6" or 12" probe length
- Connection Head
 - Cast aluminum NEMA 4X, IP66 screw cover head with captive gasket
 - One turn cover removal & installation eliminates cross threading and saves time
 - 3/4 NPT conduit opening with internal stop to prevent overtightening and installation damage
 - Gripping ribs on cover edge
 - Stainless steel cover chain
- Wiring
 - Ceramic terminal base
 - Brass terminals with stainless steel screws eliminate the need to wrap connections around screws
 - Elevated terminal block for easy wire termination
- Made in the USA

RTD Spring-Loaded Probes with Connection Head

Part Number	Pcs/Pkg	Wt (lb)	Price	Type	Probe Diameter (O.D.)	Probe Length	Temperature Sensing Range	Mounting
RTD1-C04-03	1	1.3	\$96.00	PT 100, 3-wire	1/4"	4"	-50 to 300°C (-58 to 572°F)	Integral 1/2" x 1/2" NPT Hex Nipple, 316 SS. Mount in thermowell (see accessories, purchased separately)
RTD1-C06-03			\$99.00			6"		
RTD1-C12-03			\$104.00			12"		

RTD Spring-Loaded Replacement Probes

Part Number	Pcs/Pkg	Wt (lb)	Price	Type	Probe Diameter (O.D.)	Fits Probe Length	Temperature Sensing Range	For Use With
RTD1-C04R-03	1	0.2	\$48.50	PT 100, 3-wire	1/4"	4"	-50 to 300°C (-58 to 572°F)	RTD1-C04-03
RTD1-C06R-03			\$49.50			6"		RTD1-C06-03
RTD1-C12R-03			\$52.00			12"		RTD1-C12-03

Technical Specifications

Sensing Element	Single 100Ω platinum (Pt 100), 3-wire; TCR = 0.00385 Ω/Ω/°C
Initial Accuracy	Class A ±[0.15 + 0.002 t] °C
Probe	ø1/4", 316 stainless steel sheath, single RTD is embedded in alumina powder
Connection Head	Die-cast aluminum, screw cover with stainless steel chain, compressed graphite gasket, NEMA 4X, IP66, 3/4" NPT conduit opening, Max Temp. 400°F (204°C)
Response Time	7 seconds, 63% of a 25 to 77°C step change (ASTM E1137)
Wiring	Connection head: Ceramic terminal base with brass terminals and stainless steel screws (Recommended tightening torque 3-4 lb-in) Replacement Probes: 3 inch stranded 24 AWG wire leads



Note: Check the chemical compatibility of the sensor's wetted parts with the medium to be measured.

pro^{sense}® RTD Spring-Loaded Probes with Connection Head

Dimensions

inches [mm]

RTD1-CXX-03

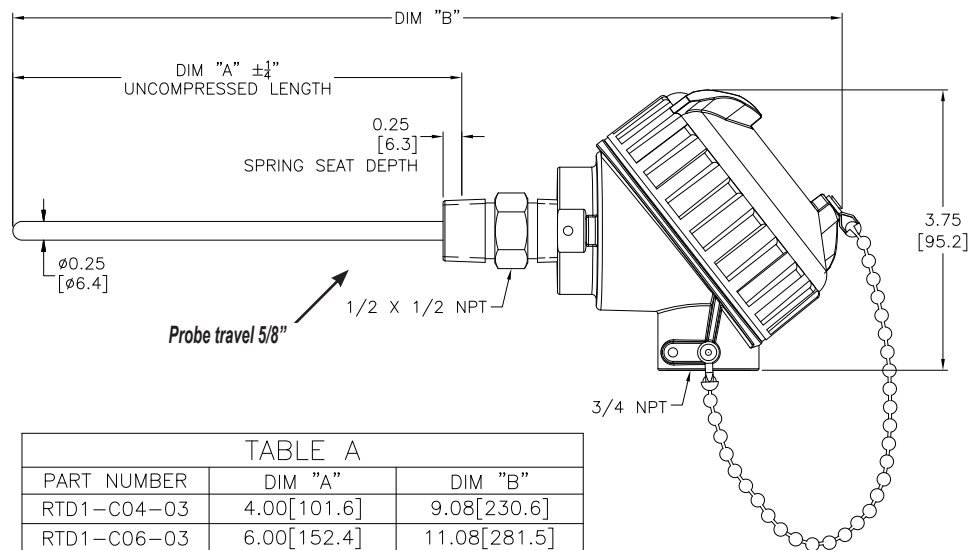

PART NUMBER	DIM "A"	DIM "B"
RTD1-C04-03	4.00[101.6]	9.08[230.6]
RTD1-C06-03	6.00[152.4]	11.08[281.5]
RTD1-C12-03	12.00[304.8]	17.08[433.8]

Wiring Information

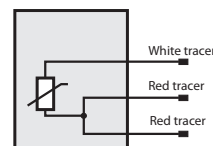
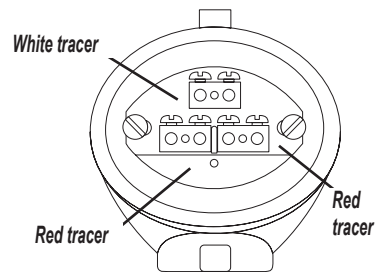

- Ignore polarity marks on terminal base
- Recommended screw terminal tightening torque 3-4 lb-in

Dimensions

inches [mm]

RTD1-CXXR-03
(Replacement Probes)

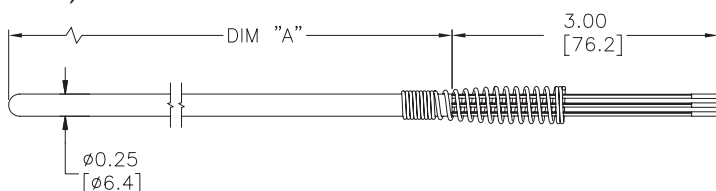

PART NUMBER	DIM "A"
RTD1-C04R-03	5.00[127.0]
RTD1-C06R-03	7.00[177.8]
RTD1-C12R-03	13.00[330.2]

Note: RTD extension lead wire available at the end of this section.
See end of section for full listing of accessories and dimension information.

Probe Replacement

1. Open top cover.
2. Disconnect wires and remove terminal block.
3. Remove snap ring at bottom of head (snap ring pliers recommended).
4. Slide out old probe and slide new probe in place.
5. While compressing spring, replace snap ring.
6. Replace terminal block and connect probe wires.

pro^{sense}® RTD Spring-Loaded Probes with Connection Head - Accessories

Accessories

Part No.	Description	Pcs/Pkg	Price
<u>TW04-01</u>	Standard duty threaded thermowell with 1/2 inch NPT male process threads, 304 stainless steel, 4-1/4 inch overall length with 0.260 inch bore diameter, for use with 4-inch long, 1/4 inch diameter spring loaded probes with 1/2 inch NPT threaded fitting, 2-1/2 inch insertion length	1	\$34.00
<u>TW04-02</u>	Standard duty threaded thermowell with 3/4 inch NPT male process threads, 304 stainless steel, 4-1/4 inch overall length with 0.260 inch bore diameter for use with 4-inch long, 1/4 inch diameter spring loaded probes with 1/2 inch NPT threaded fitting, 2-1/2 inch insertion length	1	\$34.00
<u>TW04-03</u>	Standard duty threaded thermowell with 1/2 inch NPT male process threads, 316 stainless steel, 4-1/4 inch overall length with 0.260 inch bore diameter for use with 4-inch long, 1/4 inch diameter spring loaded probes with 1/2 inch NPT threaded fitting, 2-1/2 inch insertion length	1	\$42.50
<u>TW04-04</u>	Standard duty threaded thermowell with 3/4 inch NPT male process threads, 316 stainless steel, 4-1/4 inch overall length with 0.260 inch bore diameter for use with 4-inch long, 1/4 inch diameter spring loaded probes with 1/2 inch NPT threaded fitting, 2-1/2 inch insertion length	1	\$42.50
<u>TW06-01</u>	Standard duty threaded thermowell with 1/2 inch NPT male process threads, 304 stainless steel, 6-1/4 inch overall length with 0.260 inch bore diameter for use with 6-inch long, 1/4 inch diameter spring loaded probes with 1/2 inch NPT threaded fitting, 4-1/2 inch insertion length	1	\$46.00
<u>TW06-02</u>	Standard duty threaded thermowell with 3/4 inch NPT male process threads, 304 stainless steel, 6-1/4 inch overall length with 0.260 inch bore diameter for use with 6-inch long, 1/4 inch diameter spring loaded probes with 1/2 inch NPT threaded fitting, 4-1/2 inch insertion length	1	\$46.00
<u>TW06-03</u>	Standard duty threaded thermowell with 1/2 inch NPT male process threads, 316 stainless steel, 6-1/4 inch overall length with 0.260 inch bore diameter for use with 6-inch long, 1/4 inch diameter spring loaded probes with 1/2 inch NPT threaded fitting, 4-1/2 inch insertion length	1	\$54.00
<u>TW06-04</u>	Standard duty threaded thermowell with 3/4 inch NPT male process threads, 316 stainless steel, 6-1/4 inch overall length with 0.260 inch bore diameter for use with 6-inch long, 1/4 inch diameter spring loaded probes with 1/2 inch NPT threaded fitting, 4-1/2 inch insertion length	1	\$54.00
<u>TW12-01</u>	Standard duty threaded thermowell with 1/2 inch NPT male process threads, 304 stainless steel, 12-1/4 inch overall length with 0.260 inch bore diameter for use with 12-inch long, 1/4 inch diameter spring loaded probes with 1/2 inch NPT threaded fitting, 10-1/2 inch insertion length	1	\$74.00
<u>TW12-02</u>	Standard duty threaded thermowell with 3/4 inch NPT male process threads, 304 stainless steel, 12-1/4 inch overall length with 0.260 inch bore diameter for use with 12-inch long, 1/4 inch diameter spring loaded probes with 1/2 inch NPT threaded fitting, 10-1/2 inch insertion length	1	\$74.00
<u>TW12-03</u>	Standard duty threaded thermowell with 1/2 inch NPT male process threads, 316 stainless steel, 12-1/4 inch overall length with 0.260 inch bore diameter for use with 12-inch long, 1/4 inch diameter spring loaded probes with 1/2 inch NPT threaded fitting, 10-1/2 inch insertion length	1	\$93.00
<u>TW12-04</u>	Standard duty threaded thermowell with 3/4 inch NPT male process threads, 316 stainless steel, 12-1/4 inch overall length with 0.260 inch bore diameter for use with 12-inch long, 1/4 inch diameter spring loaded probes with 1/2 inch NPT threaded fitting, 10-1/2 inch insertion length	1	\$93.00

Note: RTD extension lead wire available at www.automationdirect.com

See end of section for full listing of accessories and dimension information.

Spring-Loaded RTD Probe and Thermowell Assembly Example

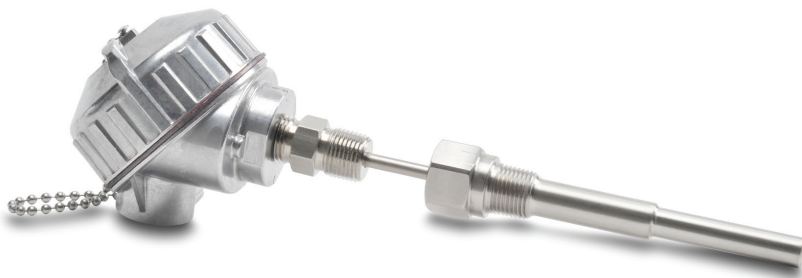

- Spring-loaded probe design ensures positive tip contact with the bottom of the thermowell.
- Integral probe hex nipple threads directly into thermowell. No additional probe mounting fittings are required.

proSense® Thermowells



Overview

- Thermowells designed for use with ProSense thermocouple and RTD probes or ProSense Thermometers eliminate the need for a separate probe mounting fitting or adapter

RTDTW Series Thermowells

- Welded 316 stainless steel construction
- 1/2" NPT male process threads
- 3-year warranty

TW Series Thermowells

- Drilled bar stock one piece construction (no welds) from 304 or 316 stainless steel
- 1/2" and 3/4" NPT male process threads available
- Designs and fabrication comply with ASME B31.1 and boiler and pressure vessel codes
- Material complies with NACE MR 0175 / ISO 15156
- CRN registered for all Canadian provinces
- 1-year warranty





Thermowells for Thermocouples -TW Series

Part Number	Pcs/Pkg	Wt(lb)	Price	I.D.	Overall Length/"U" Length	Male Process Threads	Female Probe Threads	Wetted Material	Temperature/Pressure Rating	Use With Probe or Thermometer	
TW025-01	1	0.4	\$29.50	0.26"	2-3/4" / 1"	1/2" NPT	1/2" NPT	304 SS	304SS: 1000°F max; 3400psi max	See Sensor Compatibility Table	
TW025-03	1	0.4	\$34.50			1/2" NPT		316 SS			
TW04-01	1	0.5	\$34.00		4-1/4" / 2-1/2"	1/2" NPT		304 SS			
TW04-02	1	0.5	\$34.00			3/4" NPT		304 SS			
TW04-03	1	0.5	\$42.50			1/2" NPT		316 SS			
TW04-04	1	0.5	\$42.50			3/4" NPT		316 SS			
TW06-01	1	0.7	\$46.00		6-1/4" / 4-1/2"	1/2" NPT		304 SS			304SS: 1000°F max; 3400psi max
TW06-02	1	0.7	\$46.00			3/4" NPT		304 SS			
TW06-03	1	0.7	\$54.00			1/2" NPT		316 SS			316SS: 1000°F max; 5200psi max
TW06-04	1	0.7	\$54.00			3/4" NPT		316 SS			
TW09-01	1	1.0	\$67.00		9-1/4" / 7-1/2"	1/2" NPT		304 SS			
TW09-03	1	1.0	\$78.00			1/2" NPT		316 SS			
TW12-01	1	1.2	\$74.00		12-1/4" / 10-1/2"	1/2" NPT		304 SS			
TW12-02	1	1.2	\$74.00			3/4" NPT		304 SS			
TW12-03	1	1.2	\$93.00			1/2" NPT		316 SS			
TW12-04	1	1.2	\$93.00			3/4" NPT		316 SS			

pro^{sense} Thermowells

Thermowells for Thermocouples -RTDTW Series										
Part Number	Pcs/Pkg	Wt(lb)	Price	I.D.	Overall Length	Male Process Threads	Female Probe Threads	Wetted Material	Temperature/Pressure Rating	Use With
<u>RTDTW-06-010-50N</u>	1	0.10	\$34.00	7 mm (0.28")	113mm (4.4")	1/2" NPT	1/4" NPT	316 SS	600°F (315°C) max; 232 psi (16 bar) max	XTP-160-N40140F XTP-160-0300F XTP-160-0100C RTD0100-06-010-H CF06-25N fitting
<u>RTDTW-06-020-50N</u>	1	0.20	\$36.50		213mm (8.4")					XTP-260-N40140F XTP-260-0300F XTP-260-0100C RTD0100-06-020-H CF06-25N fitting
<u>RTDTW-06-030-50N</u>	1	0.30	\$40.00		313mm (12.3")					XTP-360-N40140F XTP-360-0300F XTP-360-0100C RTD0100-06-030-H CF06-25N fitting
<u>RTDTW-10-010-50N</u>	1	0.10	\$34.00	11 mm (0.43")	92mm (3.62")	1/2" NPT				RTD0100-10-010-H CF10-50N fitting
<u>RTDTW-10-030-50N</u>	1	0.22	Retired		292mm (11.48")					CF10-50N fitting

 Note: Check the chemical compatibility of the thermowell's wetted parts with the medium to be measured.

 Note: Response time will be slower when installed in a thermowell. Be sure to install the probe so that it contacts the end of the thermowell for faster response. Thermal compound may be used depending on application

Probe & Thermowell Assembly Example

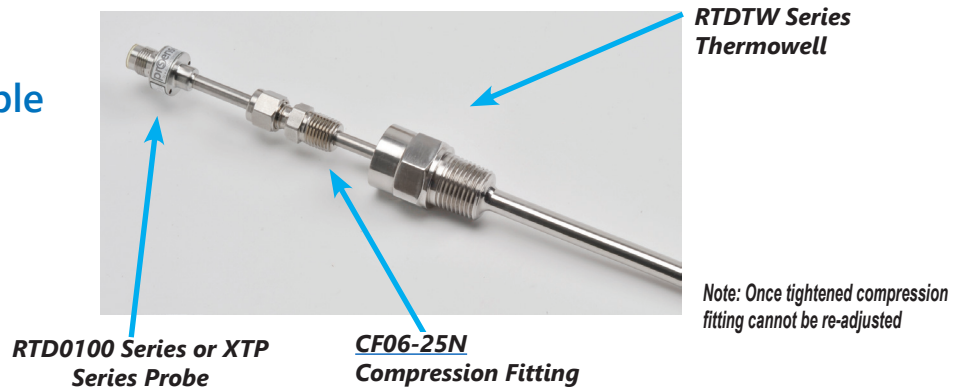

Spring-loaded Thermocouple or RTD and Thermowell Assembly Example

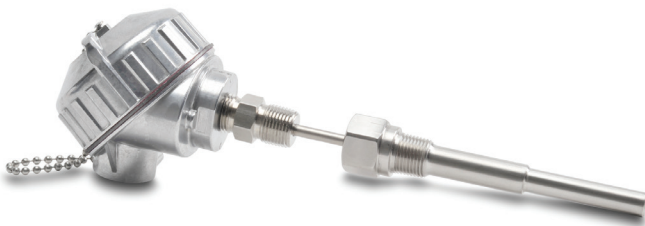

- Using spring-loaded probe design ensures positive tip contact with the bottom of the thermowell.
- Probes with hex nipple thread directly into thermowell. No additional probe mounting fittings are required.

proSense® Thermowells

Dimensions

inches [mm]

TW04-XX & TW025-XX

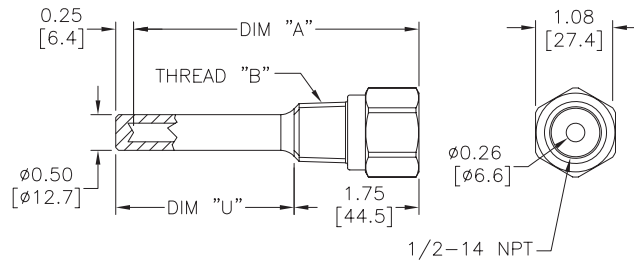

PART NUMBER	DIM "A"	THREAD "B" NPT	DIM "U"
TW025-01	2.50[63.5]	1/2-14	1.00[25.5]
TW025-03	2.50[63.5]	1/2-14	
TW04-01	4.00[101.6]	1/2-14	
TW04-02	4.00[101.6]	3/4-14	2.50[63.5]
TW04-03	4.00[101.6]	1/2-14	
TW04-04	4.00[101.6]	3/4-14	

Dimensions

inches [mm]

TW06-XX
TW09-XX
TW12-XX

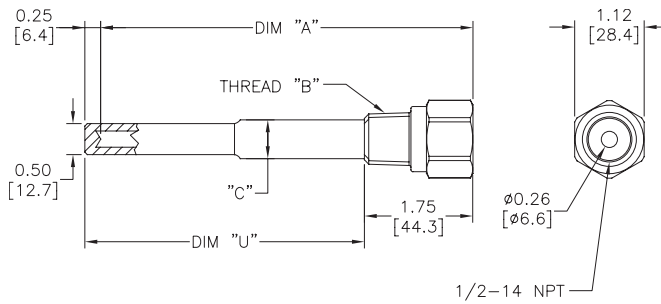

PART NUMBER	DIM "A"	THREAD "B" NPT	DIM "C"	DIM "U"
TW06-01	6.00[152.4]	1/2-14	0.63[15.9]	4.50[114.3]
TW06-02	6.00[152.4]	3/4-14	0.75[19.1]	
TW06-03	6.00[152.4]	1/2-14	0.63[15.9]	
TW06-04	6.00[152.4]	3/4-14	0.75[19.1]	7.50[190.5]
TW09-01	9.00[228.6]	1/2-14	0.63[15.9]	
TW09-03	9.00[228.6]	1/2-14	0.63[15.9]	
TW12-01	12.00[304.8]	1/2-14	0.63[15.9]	10.50[266.7]
TW12-02	12.00[304.8]	3/4-14	0.75[19.1]	
TW12-03	12.00[304.8]	1/2-14	0.63[15.9]	
TW12-04	12.00[304.8]	3/4-14	0.75[19.1]	

proSense® Thermowells

Dimensions

mm [inches]

RTDTW-06 Series

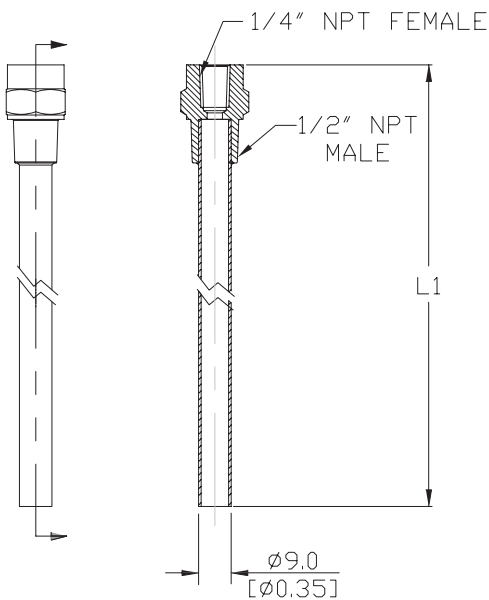

Part Number	L1
RTDTW-06-010-50N	113mm [4.4]
RTDTW-06-020-50N	213mm [8.4]
RTDTW-06-030-50N	313mm [12.3]

Torque threads to 40 lb-ft [54.23 Nm]*

* Torque values are for reference. Actual torque required for a proper seal of NPT threads is influenced by tolerance, sealant, lubricant, etc.



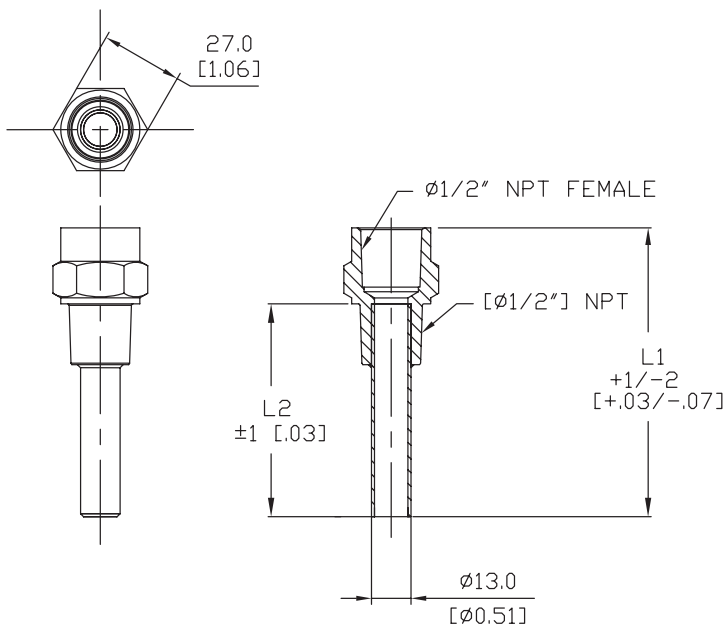



RTDTW-10 Series



Part Number	L1	L2
RTDTW-10-030-50N	92mm [3.62]	70mm [2.75]
RTDTW-10-050-50N	292mm [11.48]	270mm [10.6]

Torque threads to 40 lb-ft [54.23 Nm]*

proSense® Thermowells

TW Series Thermowells Sensor Compatibility Table						
	Connection Head	Hex Nipple	Attached Plug	Lead Wire Transition	M12	Thermometer
Thermowell						
TW025-01 TW025-03	-	-	-	-	-	T30-N40160-25C T30-0250-25C T30-50500-25C T30-150750-25C T50-N40160-25A T50-0250-25A T50-50500-25A T50-150750-25A
TW04-01 TW04-02 TW04-03 TW04-04	RTD1-C04-03 THMJ-C04-03 THMK-C04-03	RTD1-H04L01-02 THMJ-H04L01-02 THMK-H04L01-02	RTD1-P06-01 w/CF14-50N THMJ-P06-02 w/CF14-50N THMK-P06-02 w/CF14-50N	RTD1-T06L06-01 w/CF14-50N THMJ-T06L06-02 w/CF14-50N THMK-T06L06-02 w/CF14-50N	RTD1-50N-100-H RTD100-06-010-H w/CF14-50N XTP-160-N40140F w/CF14-50N XTP-160-0300F w/CF14-50N XTP-160-0100C w/CF14-50N XTP50N-100-N40140F XTP50N-100-0300F XTP50N-100-0100C ETS50N-100-1001 ETS50N-100-1003	T30-N40160-4C T30-0250-4C T30-50500-4C T30-150750-4C T50-N40160-4A T50-0250-4A T50-50500-4A T50-150750-4A
TW06-01 TW06-02 TW06-03 TW06-04	RTD1-C06-03 THMJ-C06-03 THMK-C06-03	RTD1-H06L01-02 THMJ-H06L01-02 THMK-H06L01-02	RTD1-P12-01 w/CF14-50N THMJ-P12-02 w/CF14-50N THMK-P12-02 w/CF14-50N	RTD1-T12L06-01 w/CF14-50N THMJ-T12L06-02 w/CF14-50N THMK-T12L06-02 w/CF14-50N	RTD1-50N-150-H RTD100-06-020-H w/CF14-50N XTP-260-N40140F w/CF14-50N XTP-260-0300F w/CF14-50N XTP-260-0100C w/CF14-50N XTP50N-150-N40140F XTP50N-150-0300F XTP50N-150-0100C ETS50N-150-1001 ETS50N-150-1003	T30-N40160-6C T30-0250-6C T30-50500-6C T30-150750-6C T50-N40160-6A T50-0250-6A T50-50500-6A T50-150750-6A
TW09-01 TW09-03	-	-	-	-	-	T50-N40160-9A T50-0250-9A T50-50500-9A T50-150750-9A
TW12-01 TW12-02 TW12-03 TW12-04	RTD1-C12-03 THMJ-C12-03 THMK-C12-03	RTD1-H12L01-02 THMJ-H12L01-02 THMK-H12L01-02	RTD1-P18-01 w/CF14-50N THMJ-P18-02 w/CF14-50N THMK-P18-02 w/CF14-50N	RTD1-T18L06-01 w/CF14-50N THMJ-T18L06-02 w/CF14-50N THMK-T18L06-02 w/CF14-50N	RTD100-06-030-H w/CF14-50N XTP-360-N40140F w/CF14-50N XTP-360-0300F w/CF14-50N XTP-360-0100C w/CF14-50N	-



Note: Response time will be slower when installed in a thermowell. Be sure to install the probe so that it contacts the end of the thermowell for faster response. Thermal compound may be used depending on application

proSense® Thermowells Sanitary Clean-in-Place (CIP)



STW06-01

Overview

- Sanitary Clean-In-Place 3-A approved thermowells allow the use of standard temperature sensors in hygienic applications
- All wetted parts are 316 stainless steel
- Surface finish that meets or exceeds 32µin Ra
- Up to 1500/1200 psi (103/83 bar) at 70/250 °F (21/121 °C) dependent on clamp and seal assembly.
- Bore diameter of 0.260" to accommodate sensing probes with a 0.252" maximum diameter
- Probes with integral 1/2" male NPT process threads mount directly into the thermowell. Probes without threads require a compression fitting with 1/2" male NPT threads.



Thermowells Sanitary Clean-in-Place (CIP)									
Part Number	Pcs/Pkg	Wt(lb)	Price	I.D.	Overall Length/"U" Length	Process Connection	Female Probe Threads	Wetted Material	Use With
STW04-01	1	0.75	\$101.00	ø0.260	4-1/4" / 2-1/2"	1-1/2" tri-clamp	1/2" NPT	316 stainless steel	See Sensor Compatibility Table
STW06-01	1	0.88	\$108.00		6-1/4" / 4-1/2"				
STW12-01	1	1.13	\$150.00		12-1/4" / 10-1/2"				
STW04-02	1	0.75	\$112.00		4-1/4" / 2-1/2"	2" tri-clamp			
STW06-02	1	0.88	\$120.00		6-1/4" / 4-1/2"				
STW12-02	1	1.13	\$156.00		12-1/4" / 10-1/2"				

Note: Check the chemical compatibility of the thermowell's wetted parts with the medium to be measured.

Note: Response time will be slower when installed in a thermowell. Be sure to install the probe so that it contacts the end of the thermowell for faster response. Thermal compound may be used depending on application

Probe & Thermowell Assembly Example

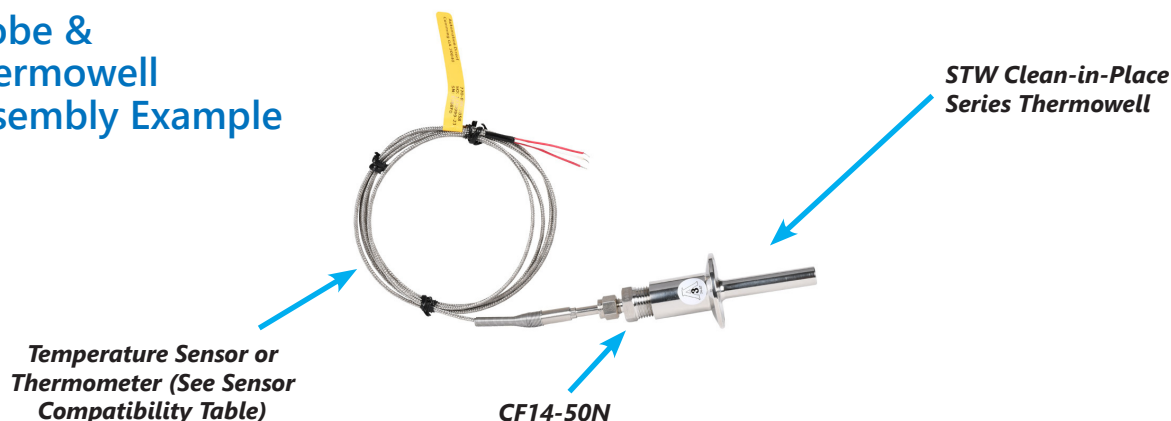

proSense® Thermowells Sanitary Clean-in-Place (CIP)

Spring-loaded Thermocouple or RTD and Thermowell Assembly Example



- Using spring-loaded probe design ensures positive tip contact with the bottom of the thermowell.
- Probes with hex nipple thread directly into thermowell. No additional probe mounting fittings are required.

Dimensions

inches [mm]

STWXX-XX

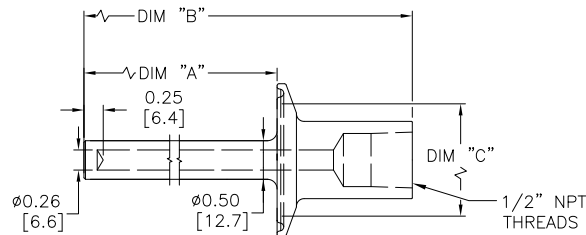







TABLE A

PART NUMBER	DIM "A"	DIM "B"	DIM "C"
STW04-01	2.50[63.5]	4.25[108.0]	1.50[38.1]
STW06-01	4.50[114.3]	6.25[158.8]	1.50[38.1]
STW12-01	10.50[266.8]	12.25[311.3]	1.50[38.1]
STW04-02	2.50[63.5]	4.25[108.0]	2.00[50.8]
STW06-02	4.50[114.3]	6.25[158.5]	2.00[50.8]
STW12-02	10.50[266.8]	12.25[311.3]	2.00[50.8]

pro^{sense} Thermowells Sanitary Clean-in-Place (CIP)

Thermowells Sanitary Clean-in-Place (CIP) Sensors Compatibility Table						
	Connection Head Sensor	Hex Nipple Sensor	Attached Plug Sensor	Lead Wire Transition Sensor	M12 Sensor	Thermometer
Thermowell						
STW04-01	RTD1-C04-03 THMJ-C04-03 THMK-C04-03	RTD1-H04L01-02 THMJ-H04L01-02 THMK-H04L01-02	RTD1-P06-01 w/CF14-50N THMJ-P06-02 w/CF14-50N THMK-P06-02 w/CF14-50N	RTD1-T06L06-01 w/CF14-50N THMJ-T06L06-02 w/CF14-50N THMK-T06L06-02 w/CF14-50N	RTD1-50N-100-H RTD0100-06-010-H w/CF14-50N XTP-160-N40140F w/CF14-50N XTP-160-0300F w/CF14-50N XTP-160-0100C w/CF14-50N XTP50N-100-N40140F XTP50N-100-0300F XTP50N-100-0100C ETS50N-100-1001 ETS50N-100-1003	T30-N40160-4C T30-0250-4C T30-50500-4C T30-150750-4C T50-N40160-4A T50-0250-4A T50-50500-4A T50-150750-4A
STW06-01	RTD1-C06-03 THMJ-C06-03 THMK-C06-03	RTD1-H06L01-02 THMJ-H06L01-02 THMK-H06L01-02	RTD1-P12-01 w/CF14-50N THMJ-P12-02 w/CF14-50N THMK-P12-02 w/CF14-50N	RTD1-T12L06-01 w/CF14-50N THMJ-T12L06-02 w/CF14-50N THMK-T12L06-02 w/CF14-50N	RTD1-50N-150-H RTD0100-06-020-H w/CF14-50N XTP-260-N40140F w/CF14-50N XTP-260-0300F w/CF14-50N XTP-260-0100C w/CF14-50N XTP50N-150-N40140F XTP50N-150-0300F XTP50N-150-0100C ETS50N-150-1001 ETS50N-150-1003	T30-N40160-6C T30-0250-6C T30-50500-6C T30-150750-6C T50-N40160-6A T50-0250-6A T50-50500-6A T50-150750-6A
STW12-01	RTD1-C12-03 THMJ-C12-03 THMK-C12-03	RTD1-H12L01-02 THMJ-H12L01-02 THMK-H12L01-02	RTD1-P18-01 w/CF14-50N THMJ-P18-02 w/CF14-50N THMK-P18-02 w/CF14-50N	RTD1-T18L06-01 w/CF14-50N THMJ-T18L06-02 w/CF14-50N THMK-T18L06-02 w/CF14-50N	RTD0100-06-030-H w/CF14-50N XTP-360-N40140F w/CF14-50N XTP-360-0300F w/CF14-50N XTP-360-0100C w/CF14-50N	-
STW04-02	RTD1-C04-03 THMJ-C04-03 THMK-C04-03	RTD1-H04L01-02 THMJ-H04L01-02 THMK-H04L01-02	RTD1-P06-01 w/CF14-50N THMJ-P06-02 w/CF14-50N THMK-P06-02 w/CF14-50N	RTD1-T06L06-01 w/CF14-50N THMJ-T06L06-02 w/CF14-50N THMK-T06L06-02 w/CF14-50N	RTD1-50N-100-H RTD0100-06-010-H w/CF14-50N XTP-160-N40140F w/CF14-50N XTP-160-0300F w/CF14-50N XTP-160-0100C w/CF14-50N XTP50N-100-N40140F XTP50N-100-0300F XTP50N-100-0100C ETS50N-100-1001 ETS50N-100-1003	T30-N40160-4C T30-0250-4C T30-50500-4C T30-150750-4C T50-N40160-4A T50-0250-4A T50-50500-4A T50-150750-4A
STW06-02	RTD1-C06-03 THMJ-C06-03 THMK-C06-03	RTD1-H06L01-02 THMJ-H06L01-02 THMK-H06L01-02	RTD1-P12-01 w/CF14-50N THMJ-P12-02 w/CF14-50N THMK-P12-02 w/CF14-50N	RTD1-T12L06-01 w/CF14-50N THMJ-T12L06-02 w/CF14-50N THMK-T12L06-02 w/CF14-50N	RTD1-50N-150-H RTD0100-06-020-H w/CF14-50N XTP-260-N40140F w/CF14-50N XTP-260-0300F w/CF14-50N XTP-260-0100C w/CF14-50N XTP50N-150-N40140F XTP50N-150-0300F XTP50N-150-0100C ETS50N-150-1001 ETS50N-150-1003	T30-N40160-6C T30-0250-6C T30-50500-6C T30-150750-6C T50-N40160-6A T50-0250-6A T50-50500-6A T50-150750-6A
STW12-02	RTD1-C12-03 THMJ-C12-03 THMK-C12-03	RTD1-H12L01-02 THMJ-H12L01-02 THMK-H12L01-02	RTD1-P18-01 w/CF14-50N THMJ-P18-02 w/CF14-50N THMK-P18-02 w/CF14-50N	RTD1-T18L06-01 w/CF14-50N THMJ-T18L06-02 w/CF14-50N THMK-T18L06-02 w/CF14-50N	RTD0100-06-030-H w/CF14-50N XTP-360-N40140F w/CF14-50N XTP-360-0300F w/CF14-50N XTP-360-0100C w/CF14-50N	-



Note: Response time will be slower when installed in a thermowell. Be sure to install the probe so that it contacts the end of the thermowell for faster response. Thermal compound may be used depending on application

proSense® Thermocouple and RTD Connectors

Overview

- Glass-filled high quality thermoplastic body with original thermocouple material pins and spring-loaded inserts
- Polarized pins
- Molded barriers prevent short circuit
- Captive central cover screw for easy assembly
- Easy wire connection pressure plate
- construction
- Stainless steel screws with combination head (Slotted and Phillips)
- 3-pin standard connectors have a third pin for ground or continuous shield, or for 3-wire RTDs

Thermocouple and RTD Connectors									
Part Number	Pcs/ Pkg	Wt(lb)	Price	Sensor Type	Connector Type	Temperature Rating	Body Color	Wire Size	Wire Cable Clamp Bracket
THMJ-SP	1	0.5	\$4.00	J	Standard round pin plug	Max continuous 400°F (200°C)	Black	32 AWG (0.2 mm) to 14 AWG maximum (2.0 mm)	WCB-S
THMJ-SJ	1	0.5	\$5.25		Standard round pin jack				-
THMJ-SPJ	1	0.5	\$10.00		Standard round direct mount jack			40 AWG (0.08 mm) to 20 AWG maximum (0.8 mm)	WCB-M
THMJ-MP	1	0.5	\$3.75		Miniature flat pin plug				-
THMJ-MJ	1	0.5	\$4.25		Miniature flat pin jack				-
THMJ-MPJ	1	0.5	\$6.75		Miniature round direct mount jack				-
THMK-SP	1	0.5	\$4.50	K	Standard round pin plug	Max continuous 662°F (350°C)	Yellow	32 AWG (0.2 mm) to 14 AWG maximum (2.0 mm)	WCB-S
THMK-SJ	1	0.5	\$5.50		Standard round pin jack				-
THMK-SPJ	1	0.5	\$10.00		Standard round direct mount jack			40 AWG (0.08 mm) to 20 AWG maximum (0.8 mm)	WCB-M
THMK-MP	1	0.5	\$4.00		Miniature flat pin plug				-
THMK-MJ	1	0.5	\$4.25		Miniature flat pin jack				-
THMK-MPJ	1	0.5	\$7.50		Miniature round direct mount jack				-
THMK-HSP	1	0.5	\$13.00	RTD	Standard hi-temp round pin plug	Max continuous 662°F (350°C)	Brown	32 AWG (0.2 mm) to 14 AWG maximum (2.0 mm)	WCB-S
THMK-HSJ	1	0.5	\$15.00		Standard hi-temp round pin jack				-
THMT-SP	1	0.5	\$4.25	T	Standard round pin plug	Max continuous 400°F (200°C)	Blue	32 AWG (0.2 mm) to 14 AWG maximum (2.0 mm)	-
THMT-SJ	1	0.5	\$5.75		Standard round pin jack				-
THMT-SPJ	1	0.5	\$9.50		Standard round direct mount jack			40 AWG (0.08 mm) to 20 AWG maximum (0.8 mm)	WCB-M
THMT-MP	1	0.5	\$4.00		Miniature flat pin plug				-
THMT-MJ	1	0.5	\$4.50		Miniature flat pin jack				-
THMT-MPJ	1	0.5	\$8.00		Miniature round direct mount jack				-
RTD-SP	1	0.5	\$9.00	RTD	Standard round pin plug	Max continuous 400°F (200°C)	White	32 AWG (0.2 mm) to 14 AWG maximum (2.0 mm)	WCB-S
RTD-SJ	1	0.5	\$11.50		Standard round pin jack				-

[THMT-SP](#)



[THMT-SJ](#)



[THMK-SP](#)



[THMK-SJ](#)



[THMK-MP](#)



[THMJ-MJ](#)



[THMT-SPJ](#)



[THMT-MPJ](#)



[RTD-SP](#)



[RTD-SJ](#)



[THMK-HSP](#)



[THMK-HSJ](#)



proense® Thermocouple and RTD Connectors

Dimensions

inches [mm]

THMJ, K, T, & H-SP

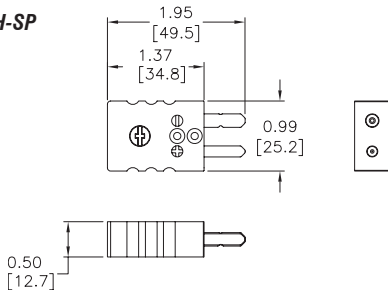

THMJ, K, T, & H-SJ

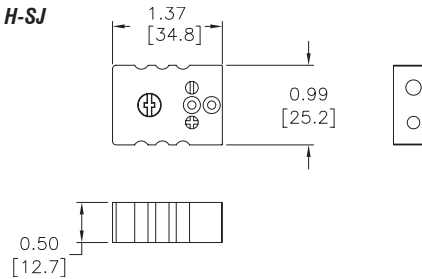

THMJ, K, & T-MP

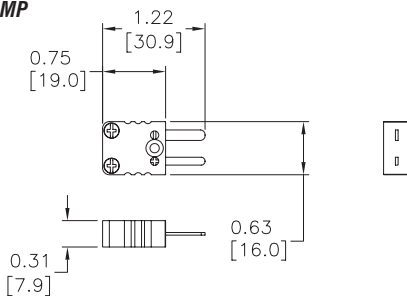

THMJ, K, & T-MJ

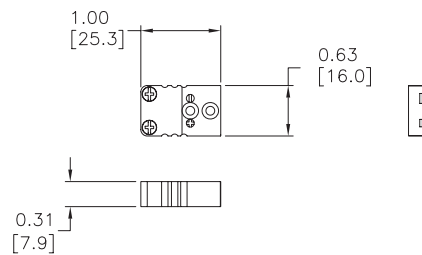

THMJ, K, & T-SPJ

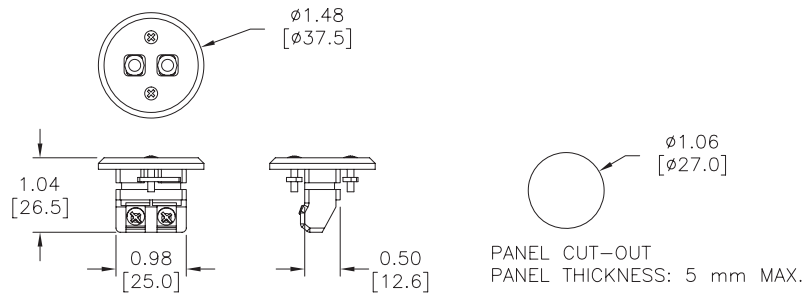

THMJ, K, & T-MPJ

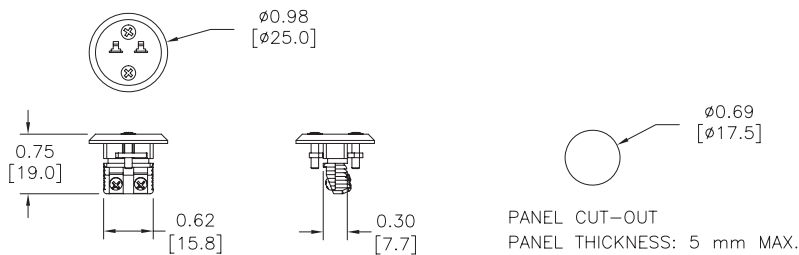

RTD-SP

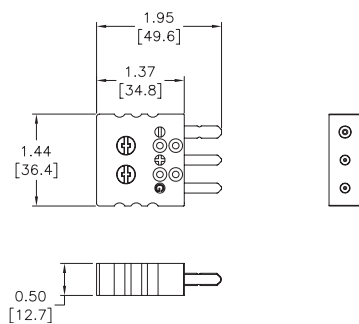

RTD-SJ

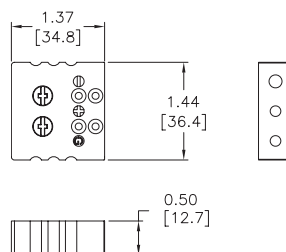

pro^{ense}® Thermocouple and RTD Connectors

WCB-S



WCB-M



WCB-S Application



WCB-M Application



Thermocouple and RTD Connectors Accessories				
Part Number	Pcs/ Pkg	Wt(lb)	Price	Description
WCB-S	4	0.5	\$7.00	Wire / cable clamp bracket for use with standard thermocouple and RTD connectors.
WCB-M	4	0.5	\$6.75	Wire / cable clamp bracket for use with miniature thermocouple connectors.

Dimensions

inches [mm]

WCB-S

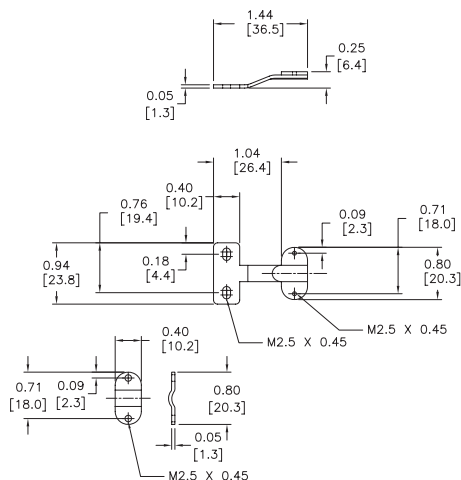

WCB-M

