

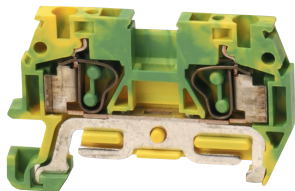

# Screwless Ground Terminal Blocks

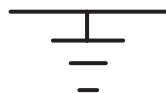

**DN-QG12**  
(Euro QE2.5/35)



Ground terminal blocks are used to mechanically and electrically connect wires to the DIN rail by means of a conducting clamping foot. In this way, the DIN rail can function as a ground bus bar.

Ground blocks are molded in green and yellow per international standards and are 35mm DIN-rail mountable.

## Ordering Information

	Part Number	Qty	Price	Part Number	Qty	Price	Part Number	Qty	Price
Green/Yellow Block	<a href="#">DN-QG12</a>	10	\$32.00	<a href="#">DN-QG10</a>	10	\$33.50	<a href="#">DN-QG8</a>	10	\$41.00

## Technical Specifications

<b>Stripping Length</b>	12mm [0.47 in]	15mm [0.59 in]	18mm [0.71 in]
<b>Density</b>	200/m [60 pcs/ft]	166/m [50 pcs/ft]	125/m [38 pcs/ft]
<b>UL Approval</b>	24-12 AWG	24-10 AWG	22-8 AWG
<b>CSA Approval</b>	24-12 AWG	24-10 AWG	22-8 AWG
<b>VDE Approval</b>	2.5 mm <sup>2</sup>	4mm <sup>2</sup>	6mm <sup>2</sup>
<b>Operating Temperature</b>	Ambient air temperature: -20 to 105°C [-4 to 221°F] / Relative humidity: 50% max at 40°C [104°F]; 90% max at 20°C [68°F]		
<b>SCCR Rating</b>	10kA per Table SB4.1, 2009, UL 508A, Maximum short circuit current rating for unmarked components		
<b>CE Conformity</b>	CE (EN 60947-1 / EN 60947-2)		
<b>Agency File #</b>	UL E179129		

## Accessories

<b>End Cover</b>	<a href="#">DN-QEC12</a>	50	\$21.50	<a href="#">DN-QEC10</a>	50	\$21.50	<a href="#">DN-QEC8</a>	50	\$25.50
	<a href="#">DN-QEC12MN</a>	10	\$5.25	<a href="#">DN-QEC10MN</a>	10	\$5.25	<a href="#">DN-QEC8MN</a>	10	\$5.75
<b>35mm DIN Rail</b>	<a href="#">DN-R35S1</a>	10	\$56.00	<a href="#">DN-R35S1</a>	10	\$56.00	<a href="#">DN-R35S1</a>	10	\$56.00
	<a href="#">DN-R35S1-2</a>	2	\$14.00	<a href="#">DN-R35S1-2</a>	2	\$14.00	<a href="#">DN-R35S1-2</a>	2	\$14.00
<b>End Brackets</b>	<a href="#">DN-EB35</a>	50	\$67.00	<a href="#">DN-EB35</a>	50	\$67.00	<a href="#">DN-EB35</a>	50	\$67.00
	<a href="#">DN-EB35MN</a>	20	\$31.50	<a href="#">DN-EB35MN</a>	20	\$31.50	<a href="#">DN-EB35MN</a>	20	\$31.50
	<a href="#">DN-EB35-A</a>	50	\$47.50	<a href="#">DN-EB35-A</a>	50	\$47.50	<a href="#">DN-EB35-A</a>	50	\$47.50
	<a href="#">DN-EB35-A-10</a>	10	\$12.00	<a href="#">DN-EB35-A-10</a>	10	\$12.00	<a href="#">DN-EB35-A-10</a>	10	\$12.00
	<a href="#">DN-QEB35</a>	50	\$42.50	<a href="#">DN-QEB35</a>	50	\$42.50	<a href="#">DN-QEB35</a>	50	\$42.50
	<a href="#">DN-QEB35-10</a>	10	\$11.50	<a href="#">DN-QEB35-10</a>	10	\$11.50	<a href="#">DN-QEB35-10</a>	10	\$11.50
<b>Angled Support Bracket</b>	<a href="#">DN-ASB1</a>	50	\$107.00	<a href="#">DN-ASB1</a>	50	\$107.00	<a href="#">DN-ASB1</a>	50	\$107.00
<b>Marking Tags</b>	DN-QL Series	500	various	DN-QL Series	500	various	DN-QL Series	500	various

Note: For more information on accessories, see the DINnectors Accessories section of this chapter.

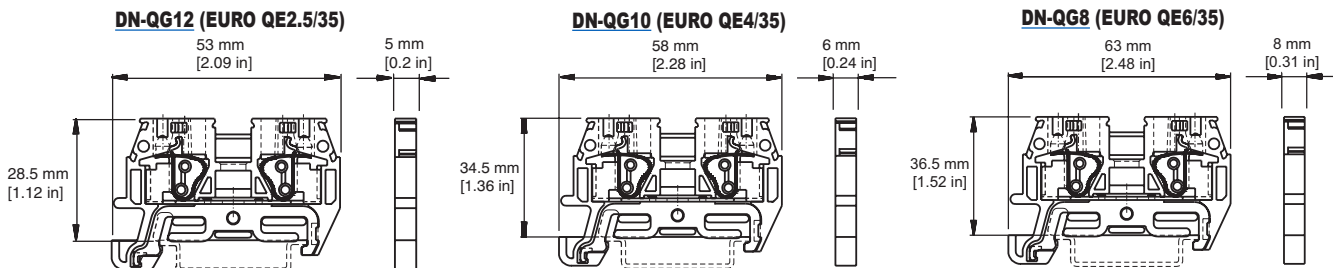



# Screwless Ground Terminal Blocks

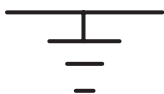

Ordering Information						
	Part Number	Qty	Price	Part Number	Qty	Price
Green/Yellow Block	<a href="#">DN-QG12-1-2</a>	10	\$56.00	<a href="#">DN-QG12-2-2</a>	10	\$64.00
Technical Specifications						
Stripping Length	12mm [0.47 in]			12mm [0.47 in]		
Density	200/m [60 pcs/ft]			200/m [60 pcs/ft]		
UL Approval	24-12 AWG			24-12 AWG		
CSA Approval	24-12 AWG			24-12 AWG		
VDE Approval	2.5 mm <sup>2</sup>			2.5 mm <sup>2</sup>		
Operating Temperature	Ambient air temperature: -20 to 105°C [-4 to 221°F] Relative humidity: 50% max at 40°C [104°F]; 90% max at 20°C [68°F]					
SCCR Rating	10kA per Table SB4.1, 2009, UL 508A, Maximum short circuit current rating for unmarked components					
CE Conformity	CE (EN 60947-1 / EN 60947-7-2)					
Agency File #	UL E179129					
Accessories						
End Cover	<a href="#">DN-QEC12-1-2</a>	25	\$15.00	<a href="#">DN-QEC12-2-2</a>	25	\$16.50
35mm DIN Rail	<a href="#">DN-R35S1</a>	10	\$56.00	<a href="#">DN-R35S1</a>	10	\$56.00
	<a href="#">DN-R35S1-2</a>	2	\$14.00	<a href="#">DN-R35S1-2</a>	2	\$14.00
End Brackets	<a href="#">DN-EB35</a>	50	\$67.00	<a href="#">DN-EB35</a>	50	\$67.00
	<a href="#">DN-EB35MN</a>	20	\$31.50	<a href="#">DN-EB35MN</a>	20	\$31.50
	<a href="#">DN-EB35-A</a>	50	\$47.50	<a href="#">DN-EB35-A</a>	50	\$47.50
	<a href="#">DN-EB35-A-10</a>	10	\$12.00	<a href="#">DN-EB35-A-10</a>	10	\$12.00
	<a href="#">DN-QEB35</a>	50	\$42.50	<a href="#">DN-QEB35</a>	50	\$42.50
	<a href="#">DN-QEB35-10</a>	10	\$11.50	<a href="#">DN-QEB35-10</a>	10	\$11.50
Angled Support Bracket	<a href="#">DN-ASB1</a>	50	\$107.00	<a href="#">DN-ASB1</a>	50	\$107.00
Marking Tags	DN-QL-Series	500	various	DN-QL Series	500	various

Note: For more information of accessories, see the DINnectors Accessories section of this chapter.

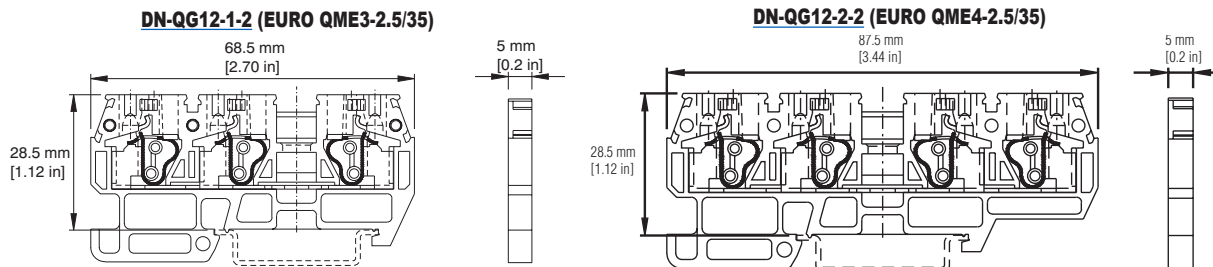

# Screwless Terminal Blocks Overview

## Why go screwless?

Screwless clamping technology offers several benefits:

- **Speed:** On average, screwless connections can be made in half the time of screw type connections, cutting installation labor costs in half.
- **Ease:** No need for twisting and turning screws, so screwless terminal blocks are much easier on the installer's hands and arms. Also, wiring from the top of the terminal blocks allow installers to accurately and reliably see the wire fully inserted into the spring clamp.
- **Safety:** Never have a problem with faulty connections from loose screws again! Meets the same UL, CSA, and IEC standards as screw-type terminal blocks.
- **Maintenance-free:** The screwless spring clamp conforms to the wire with constant tension, making it maintenance-free.

## Are there any trade-offs of going screwless versus screw-type?

Unless you need to clamp multiple wires to the same connection point, the answer is no. If you do, then there may be a slight trade-off in requiring more panel space than with screw terminal blocks. Unlike screw terminal blocks, screwless terminal block spring-clamps are designed to clamp a single wire, only. This is why multiple versions exist like the "one-to-two" or "two-to-two." These versions allow multiple wires to be connected together via multiple spring clamps.

## How does it work?

Well, it's pretty simple: Push, Insert, Release. Just push your screwdriver into the spring clamp (a rectangular shaped hole) to open the spring clamp (a circular shaped hole), insert the stripped wire into the clamp (a circular shaped hole), and pull out your screwdriver to release the clamp against the wire. That's it. The connection is made.

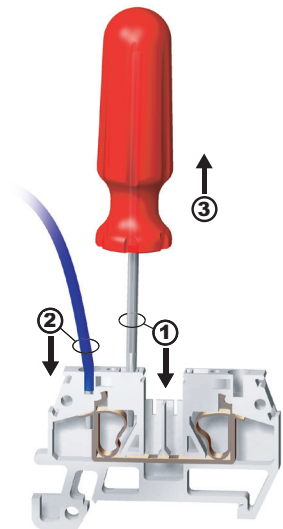

## How do the jumpers work?

1

Properly align jumper bar with terminal block center jumper slots.

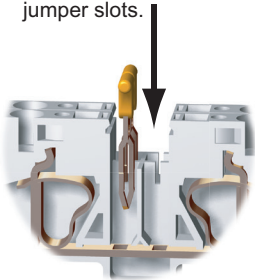

2

Push down until firmly seated.

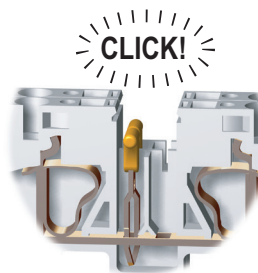

Removal

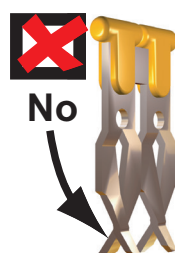
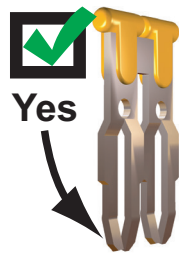
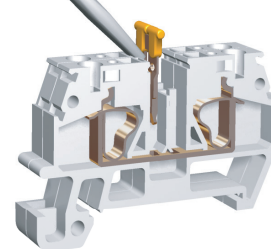

Yes = Good, acceptable jumper  
No = Bad, damaged jumper

# **DINnectors** Accessories

## Steel DIN Rails Features

### 35mm wide

- Available in 1-meter lengths
- 7.5 mm-high rails primarily used to mount terminal blocks, relays, timers and small PLCs such as the BRX, CLICK, DirectLogic and Productivity series. 15mm-high rails for mounting larger and heavier components such as contactors and larger PLCs

### 15mm wide

- Available in 1-meter lengths
- DN-R15S1 exclusively for mounting mini terminal blocks such as the DN-M10-A

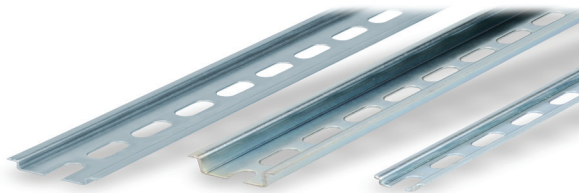

Steel DIN Rails Specifications									
	Part Number	Qty	Price	Part Number	Qty	Price	Part Number	Qty	Price
<b>DIN Rail</b>	<a href="#"><u>DN-R35S1</u></a>	10	\$56.00	<a href="#"><u>DN-R35HS1</u></a>	10	\$93.00	<a href="#"><u>DN-R15S1</u></a>	10	\$47.50
	<a href="#"><u>DN-R35S1-2</u></a>	2	\$14.00	<a href="#"><u>DN-R35HS1-2</u></a>	2	\$23.00	<a href="#"><u>DN-R15S1-2</u></a>	2	\$14.00
<b>Description</b>	DINnector DIN rail, slotted, 35mm, 7.5mm height, 1m length, plated steel. Package of 10.			DINnector DIN rail, slotted, 35mm, 15mm height, 1m length, plated steel. Package of 10.			DINnector DIN rail, slotted, 15mm, 5.5mm height, 1m length, plated steel. Package of 2.		
<b>Plating</b>	Zinc-plated and chromated								
<b>International Standards</b>	EN 60715, RoHs								
<b>Suggested Mounting Screw Type</b>	M6			M6			M4		

## Aluminum DIN Rail Features

### 35mm wide

- Non-anodized finish
- Zinc plating and passivation (minimum thickness 6 microns)
- Lightweight, easy to cut and deburr
- Terminal blocks only
- Maximum mounting screw #10-32 or M5
- Available in 1-meter lengths

### 35mm wide raised

- Non-anodized finish
- Zinc plating and passivation (minimum thickness 6 microns)
- Enables users to raise terminal blocks 2¼" above the back panel
- Terminal blocks only
- Available in 1-meter lengths
- Bushing or grommet recommended for wire access hole (example Heyco UB-875 not sold by ADC)

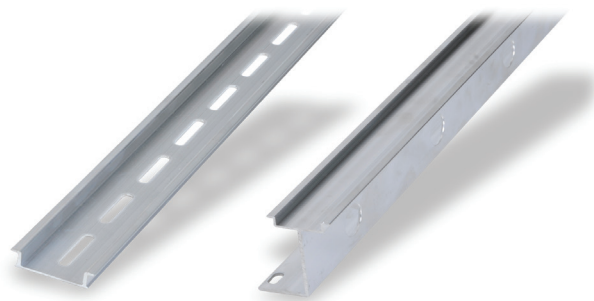

Aluminum DIN Rails Specifications						
	Part Number	Qty	Price	Part Number	Qty	Price
<b>DIN Rail</b>	<a href="#"><u>DN-R35SAL1</u></a>	10	\$52.00	<a href="#"><u>DN-R35SAL2-2</u></a>	2	\$34.50
	<a href="#"><u>DN-R35SAL1-2</u></a>	2	\$11.00			
<b>Description</b>	DINnector DIN rail, slotted, 35mm, 10mm height, 1m length, aluminum. Package of 10.			DINnector DIN rail, slotted, 2in raised 35mm, 7.5mm height, 1m length, aluminum. Package of 2.		
<b>Plating</b>	Galvanic zinc plating, non-anodized finish					
<b>International Standards</b>	DIN 50960, RoHs					
<b>Suggested Mounting Screw Type</b>	#10-32 or M5					

# **DINnectors** Accessories

## DIN rail support brackets

- Angled support brackets raise and tilt mounting rails 30 degrees from mounting surface for easier wiring
- [DN-ASB1](#) plated steel support bracket
- [DN-ASB2-10](#) cold-rolled steel treated with galvanic zinc plating and passivation

## DIN rail mounting clips

- Snap small devices not made for mounting onto 35mm DIN rails
- Zinc plated steel

DIN Rail Support Brackets and Mounting Clips			
Part Number	Description	Qty	Price
<a href="#">DN-ASB1</a>	30° angled DIN rail support bracket (M6-1.0 screws not included)	50	\$107.00
<a href="#">DN-ASB2-10</a>	30° angled DIN rail support bracket (M6-1.0 screws included)	10	\$18.00
<a href="#">DN-SSB25-10</a>	1" (25 mm) DIN rail support bracket (M6-1.0 screws included)	10	\$24.50
<a href="#">DN-SSB50-10</a>	2" (50 mm) DIN rail support bracket (M6-1.0 screws included)	10	\$25.50
<a href="#">DN-SSB70-10</a>	2.75" (70 mm) DIN rail support bracket (M6-1.0 screws included)	10	\$32.00
<a href="#">DN-SSB90-10</a>	3.5" (90 mm) DIN rail support bracket (M6-1.0 screws included)	10	\$34.50
<a href="#">DN-CLIP-FM4</a>	DIN rail mounting clip with M4 x 0.7 mm threaded hole (Screws not included)	40	\$66.00
<a href="#">DN-CLIP-FM4-5</a>		5	\$9.50
<a href="#">DN-CLIP-FM5</a>	DIN rail mounting clip with M5 x 0.8 mm threaded hole (Screws not included)	40	\$66.00
<a href="#">DN-CLIP-FM5-5</a>		5	\$9.50

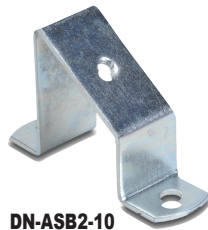
**DN-ASB1****DN-ASB2-10****DN-SSB25-10****DN-SSB50-10****DN-SSB70-10****DN-SSB90-10****DN-CLIP-FM4**  
**DN-CLIP-FM4-5****DN-CLIP-FM5**  
**DN-CLIP-FM5-5**

# DINnectors® Accessories

## DIN Rail Support Brackets and Mounting Clips

### Dimensions

mm [inches]

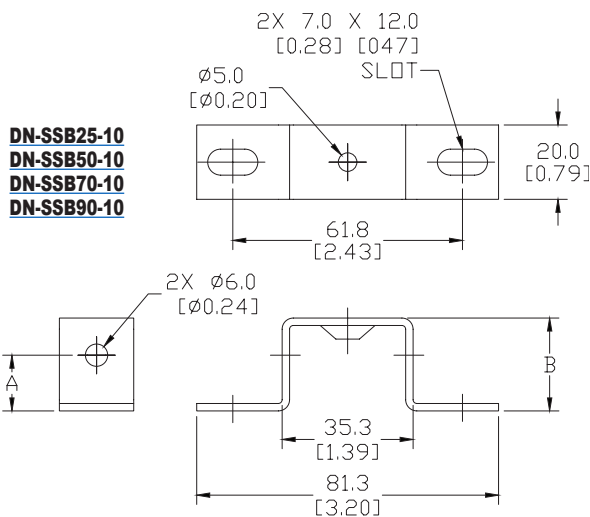
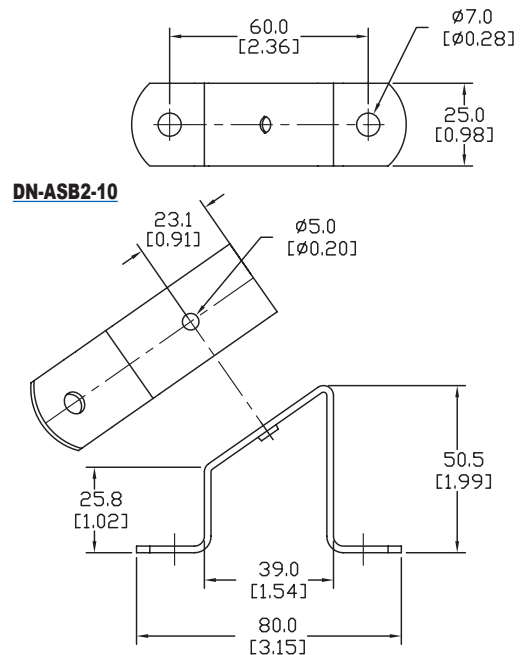
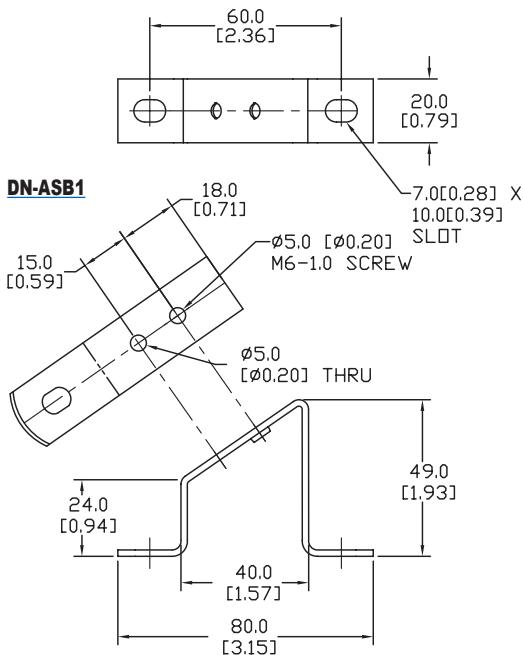

DIN Rail Support Brackets		
Part Number	DIM A mm [inches]	DIM B mm [inches]
<b>DN-SSB25-10</b>	15.0 [0.59]	25.0 [0.98]
<b>DN-SSB50-10</b>	40.0 [1.58]	50.0 [1.97]
<b>DN-SSB70-10</b>	60.0 [2.36]	70.0 [2.76]
<b>DN-SSB90-10</b>	80.0 [3.15]	90.0 [3.54]

See our website: [www.AutomationDirect.com](http://www.AutomationDirect.com) for complete engineering drawings

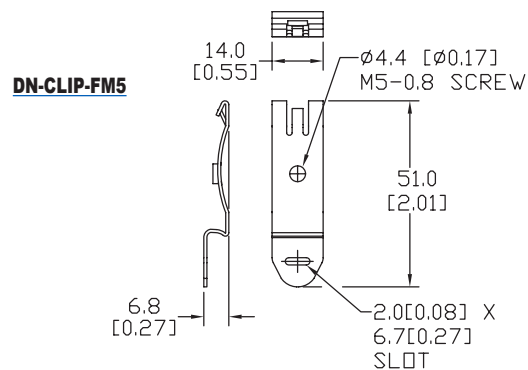
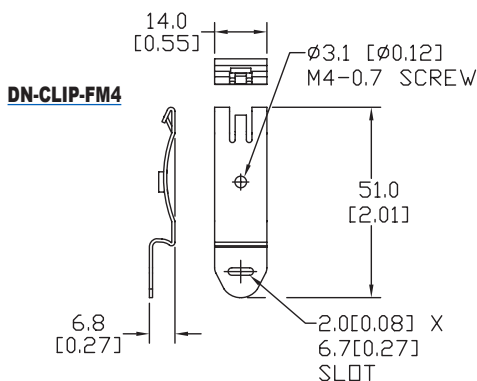

# DINnectors® Accessories

## Jumpers

Multi-pole jumper bars for DINnector terminal blocks

Multi-pole Jumper Bars										
Part Number	Qty	Price	Part Number	Qty	Price	# of Poles	Rating		Insulation Color	For Use With Terminal Block Series
							(V)	(A)		
<a href="#">DN-2J2YMN</a>	25	\$13.00	<a href="#">DN-2J2Y</a>	100	\$43.00	2	600	25	Orange	<a href="#">DN-T12-A</a> , <a href="#">DN-EMX</a> , <a href="#">DN-Q12-A</a> , <a href="#">DN-QD12-A</a> , <a href="#">DN-QEMX</a> , <a href="#">DN-QKBD12-A</a>
<a href="#">DN-2J4YMN</a>	25	\$14.50	<a href="#">DN-2J4Y</a>	100	\$46.00	2	600	25	Yellow	<a href="#">DN-T10-A</a> , <a href="#">DN-D10-A</a> , <a href="#">DN-M10-A</a> , <a href="#">DN-Q10-A</a>
<a href="#">DN-2J6YMN</a>	25	\$15.00	<a href="#">DN-2J6Y</a>	100	\$60.00	2	600	30	Green	<a href="#">DN-Q8-A</a>
–	–	–	<a href="#">DN-2J6</a>	100	\$76.00	2	600	65	–	<a href="#">DN-T6</a>
<a href="#">DN-2JL14-AMN</a>	25	\$15.00	<a href="#">DN-2JL14-A</a>	100	\$67.00	2	300	20	Red	<a href="#">DN-TL-A</a>
<a href="#">DN-2JL14B-AMN</a>	25	\$15.00	<a href="#">DN-2JL14B-A</a>	100	\$67.00	2	300	20	Blue	<a href="#">DN-TL-A</a>
<a href="#">DN-3J2YMN</a>	25	\$18.00	<a href="#">DN-3J2Y</a>	100	\$62.00	3	600	25	Orange	<a href="#">DN-T12-A</a> , <a href="#">DN-EMX</a> , <a href="#">DN-Q12-A</a> , <a href="#">DN-QD12-A</a> , <a href="#">DN-QEMX</a> , <a href="#">DN-QKBD12-A</a>
<a href="#">DN-3J4YMN</a>	25	\$22.00	<a href="#">DN-3J4Y</a>	100	\$74.00	3	600	25	Yellow	<a href="#">DN-T10-A</a> , <a href="#">DN-D10-A</a> , <a href="#">DN-M10-A</a> , <a href="#">DN-Q10-A</a>
<a href="#">DN-3J6YMN</a>	25	\$23.50	<a href="#">DN-3J6Y</a>	100	\$84.00	3	600	30	Green	<a href="#">DN-Q8-A</a>
–	–	–	<a href="#">DN-3J6</a>	100	\$132.00	3	600	65	–	<a href="#">DN-T6</a>
<a href="#">DN-3JL14-AMN</a>	25	\$23.00	<a href="#">DN-3JL14-A</a>	100	\$99.00	3	300	20	Red	<a href="#">DN-TL-A</a>
<a href="#">DN-3JL14B-AMN</a>	25	\$23.00	<a href="#">DN-3JL14B-A</a>	100	\$99.00	3	300	20	Blue	<a href="#">DN-TL-A</a>
			<a href="#">DN-4J6</a>	100	\$169.00	4	600	65	–	<a href="#">DN-T6</a>
			<a href="#">DN-12J6Y</a>	10	\$35.50	12	600	30	Green	<a href="#">DN-Q8-A</a>
			<a href="#">DN-12JL14-A</a>	10	\$26.50	12	300	20	Red	<a href="#">DN-TL-A</a>
			<a href="#">DN-12JL14B-A</a>	10	\$26.50	12	300	20	Blue	<a href="#">DN-TL-A</a>
			<a href="#">DN-12JFE</a>	10	\$60.00	12	300	25	Blue	<a href="#">DN-FE4</a>
			<a href="#">DN-24J2Y</a>	5	\$28.00	24	600	25	Orange	<a href="#">DN-T12-A</a> , <a href="#">DN-EMX</a> , <a href="#">DN-Q12-A</a> , <a href="#">DN-QD12-A</a> , <a href="#">DN-QEMX</a> , <a href="#">DN-QKBD12-A</a>
			<a href="#">DN-24J4Y</a>	5	\$29.50	24	600	25	Yellow	<a href="#">DN-T10-A</a> , <a href="#">DN-D10-A</a> , <a href="#">DN-M10-A</a> , <a href="#">DN-Q10-A</a>
			<a href="#">DN-24J8</a>	5	\$41.00	24	600	50	Green	<a href="#">DN-T8</a>
			<a href="#">DN-55J6</a>	1	\$26.50	55	600	65	–	<a href="#">DN-T6</a>

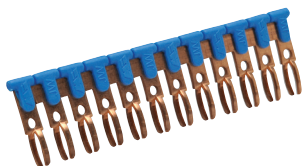

[DN-12JL14B-A](#)

## Dimensions

mm [inches]

[DN-xJ2Y](#) / [DN-xJ2YMN](#)

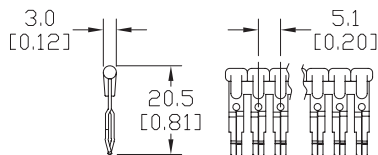

[DN-xJ6Y](#) / [DN-xJ6YMN](#)

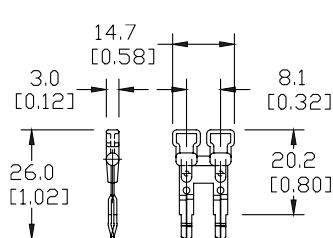

[DN-xJ4Y](#) / [DN-xJ4YMN](#)

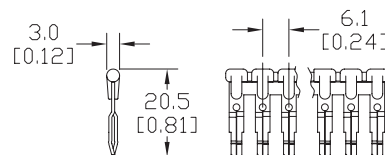

[DN-24J8](#)

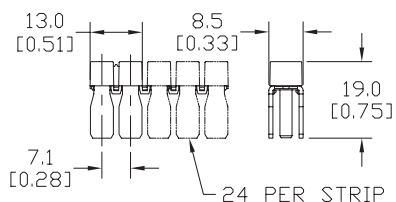

[DN-12JFE](#)

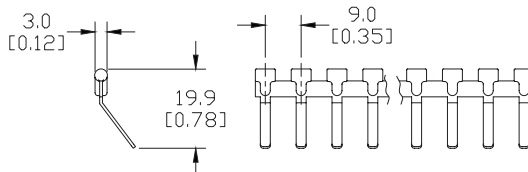

[DN-xJL14](#) / [DN-xJL14x-AMN](#)  
[DN-xJ14x-A](#)

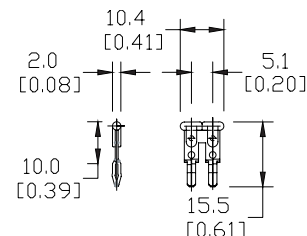

# DINnectors® Accessories

## Modifying a DN-24J8 jumper bar to the required number of poles

1) Place the insulating part into the jumper bar and insert screws, based on number of poles required.  
(For instance, in the following example, 5 poles are required). Click into place.

2) Using a cutting tool, cut the insulating part at the edge of the jumper bar (see below).

3) Hold the metal jumper bar and insulating jumper with two hands, placing fingers to the left and right of the pole you wish to cut, repeatedly flexing up and down (1 or 2 times should be sufficient) until the jumper bar and insulating jumper break in two.

4) Remove the small remaining piece of jumper (see below). This is important to ensure appropriate insulation distance in the case of contiguously applied jumpers in sequence. This step also facilitates the placement of a separator terminal if the bridge is positioned as the last terminal of a group.

5) The jumpers now are ready to be screwed onto DN-T8 series terminal blocks.

## Jumper Cutting Tools

Jumper cutting tools maintain protective covering.

Jumper Cutting Tools			
Part Number	Description	Qty	Price
<a href="#"><u>DN-J2CUT</u></a>	DINnector jumper cutting tool, for use with DN-2J2Y, DN-3J2Y and DN-24J2Y jumpers.	1	\$79.00
<a href="#"><u>DN-J4CUT</u></a>	DINnector jumper cutting tool, for use with DN-2J4Y, DN-3J4Y and DN-24J4Y jumpers.	1	\$79.00
<a href="#"><u>DN-J6CUT</u></a>	DINnector jumper cutting tool, for use with DN-12J6Y jumpers.	1	\$118.00
<a href="#"><u>DN-JL14CUT</u></a>	DINnector jumper cutting tool, for use with DN-12JL14-A and DN-12JL14B-A jumpers.	1	\$112.00
<a href="#"><u>DN-JXCUT</u></a>	DINnector jumper cutting tool, for use with DN-J2DIE, DN-J4DIE, DN-J6DIE, DN-JL14DIE and DN-JFEDIE dies.	1	\$76.00
<a href="#"><u>DN-JFECUT</u></a>	DINnector jumper cutting tool, for use with DN-12JFE jumpers.	1	\$92.00
<a href="#"><u>DN-JKIT</u></a>	DINnector cutting tool kit for DN series jumpers. Includes (1) DN-JXCUT cutting tool, (5) dies (DN-J2DIE, DN-J4DIE, DN-J6DIE, DN-JL14DIE, and DN-JFEDIE).	1	\$313.00
<a href="#"><u>DN-TOOL2</u></a>	DINnector tool kit, for use with DN series terminal blocks, includes (1) spring opening tool for DN-Q series screwless terminal blocks and (1) jumper removal tool for J2, J4, J6, and JL14 jumpers.	1	\$11.50



**DN-J2CUT**



**DN-J4CUT**



**DN-JKIT**



**DN-TOOL2**

Replacement Dies		
Part Number	Description	Price
<a href="#"><u>DN-J2DIE</u></a>	DINnector replacement die, package of 2. For use with jumper cutting tools DN-J2CUT or DN-JXCUT.	\$118.00
<a href="#"><u>DN-J4DIE</u></a>	DINnector replacement die, package of 2. For use with jumper cutting tools DN-J4CUT or DN-JXCUT.	\$118.00
<a href="#"><u>DN-JFEDIE</u></a>	DINnector replacement die, package of 2. For use with jumper cutting tools DN-JFECUT or DN-JXCUT.	\$92.00
<a href="#"><u>DN-J6DIE</u></a>	DINnector replacement die, package of 2. For use with jumper cutting tools DN-J6CUT or DN-JXCUT.	\$118.00
<a href="#"><u>DN-JL14DIE</u></a>	DINnector replacement die, package of 2. For use with jumper cutting tools DN-JL14CUT or DN-JXCUT.	\$118.00

# DINnectors® Accessories

## Terminal Plugs



**DN-xxPLUG / DN-xxPLUGMN**

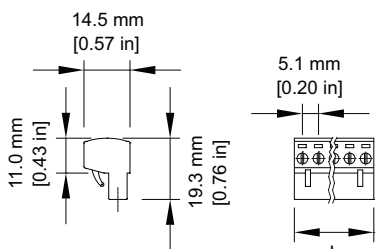

Accessories – Terminal Plugs							
Plugs* Part Number	Qty	Price	Plugs* Part Number	Qty	Price	Number of Poles	Length mm [in]
<a href="#">DN-2PLUG</a>	200	\$115.00	<a href="#">DN-2PLUGMN</a>	10	\$7.25	2	10.2 [0.40]
<a href="#">DN-3PLUG</a>	200	\$177.00	<a href="#">DN-3PLUGMN</a>	10	\$11.50	3	15.2 [0.60]
<a href="#">DN-4PLUG</a>	100	\$118.00	<a href="#">DN-4PLUGMN</a>	10	\$14.50	4	20.3 [0.80]
<a href="#">DN-5PLUG</a>	100	\$136.00	<a href="#">DN-5PLUGMN</a>	10	\$18.00	5	25.4 [1.00]
<a href="#">DN-6PLUG</a>	100	\$176.00	<a href="#">DN-6PLUGMN</a>	10	\$18.00	6	30.5 [1.20]
<a href="#">DN-7PLUG</a>	50	\$92.00	<a href="#">DN-7PLUGMN</a>	5	\$14.50	7	35.6 [1.40]
<a href="#">DN-8PLUG</a>	50	\$117.00	<a href="#">DN-8PLUGMN</a>	5	\$14.50	8	40.6 [1.60]
<a href="#">DN-9PLUG</a>	50	\$128.00	<a href="#">DN-9PLUGMN</a>	5	\$15.00	9	45.7 [1.80]
<a href="#">DN-10PLUG</a>	50	\$136.00	<a href="#">DN-10PLUGMN</a>	5	\$17.00	10	50.8 [2.00]
<a href="#">DN-11PLUG</a>	50	\$161.00	<a href="#">DN-11PLUGMN</a>	5	\$19.50	11	55.9 [2.20]
<a href="#">DN-12PLUG</a>	50	\$176.00	<a href="#">DN-12PLUGMN</a>	5	\$20.00	12	61.0 [2.40]
Terminal Plugs Ratings							
<b>Voltage/Current</b>	300V, 12A						
<b>Wire Gauge</b>	14–22 AWG, CU only						
<b>Torque</b>	Tightening Torque: 0.51 N·m [4.5 lb·in]						
<b>Usage Temperature</b>	Ambient air temperature: -20 to 105°C [-4 to 221°F] Relative humidity: 50% max at 40°C [104°F]; 90% max at 20°C [68°F]						
<b>Agency Approvals</b>	UL file #: E179129						

Note: To obtain the most current agency approval information, see the Agency Approval Checklist section on the specific part number's web page.

\* DN-xxPLUGs fit all DN-EMXxx & DN-QEMXxx plug-in terminal blocks

## Disconnect Blade



**DN-DIS-BLADE  
DN-DIS-BMN**

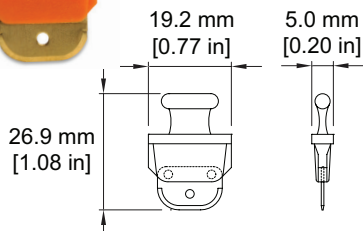

Disconnect Blade			
Part Number	Description	Qty	Price
<a href="#">DN-DIS-BLADE</a>	Terminal block disconnect blade for DN-FE2, DN-FE4, DN-DIS2 and DN-DIS4	50	\$36.00
<a href="#">DN-DIS-BMN</a>		10	\$9.75

## End Brackets

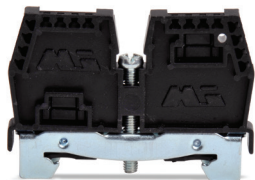

End Brackets		
Part Number	Description	Price
<a href="#">DN-EB15</a>	DINnecter snap-on end bracket, 7mm wide. Package of 100. For use with 15mm DIN rail.	\$108.00
<a href="#">DN-EB15MN</a>	DINnecter snap-on end bracket, 7mm wide. Package of 20. For use with 15mm DIN rail.	\$25.50
<a href="#">DN-EB35</a>	DINnecter screw-down end bracket, 9mm wide. Package of 50. For use with 35mm DIN rail.	\$67.00
<a href="#">DN-EB35MN</a>	DINnecter screw-down end bracket, 9mm wide. Package of 20. For use with 35mm DIN rail.	\$31.50
<a href="#">DN-EB35-A</a>	DINnecter screw-down end bracket, 6mm wide. Package of 50. For use with 35mm DIN rail.	\$47.50
<a href="#">DN-EB35-A-10</a>	DINnecter screw-down end bracket, 6mm wide. Package of 10. For use with 35mm DIN rail.	\$12.00
<a href="#">DN-QEB35</a>	DINnecter snap-on end bracket, 6mm wide. Package of 50. For use with 35mm DIN rail.	\$42.50
<a href="#">DN-QEB35-10</a>	DINnecter snap-on end bracket, 6mm wide. Package of 10. For use with 35mm DIN rail.	\$11.50

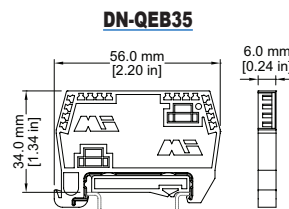
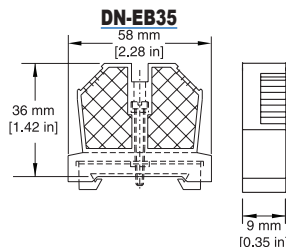
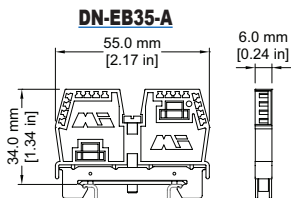
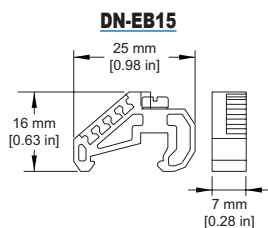

For more information on accessories, see the "DINnectors Accessories" section of this section.

# **DINnectors** Accessories

## End Covers

Certain end covers can be used with multiple terminal block parts to cover and insulate the open side, or to put more space between adjacent blocks.

DINnectors End Covers		
Part Number	Description	Price
<a href="#">DN-EC1210</a>	DINnector terminal block end cover, gray. Package of 100. For use with DN-T12 or DN-T10 series terminal blocks.	\$43.00
<a href="#">DN-EC1210MN</a>	DINnector terminal block end cover, gray. Package of 25. For use with DN-T12 or DN-T10 series terminal blocks.	\$14.50
<a href="#">DN-EC86</a>	DINnector terminal block end cover, gray. Package of 100. For use with DN-T8 or DN-T6 series terminal blocks.	\$47.00
<a href="#">DN-EC86MN</a>	DINnector terminal block end cover, gray. Package of 25. For use with DN-T8 or DN-T6 series terminal blocks.	\$14.50
<a href="#">DN-EC4</a>	DINnector terminal block end cover, gray. Package of 50. For use with DN-T4 series terminal blocks.	\$29.50
<a href="#">DN-EC4MN</a>	DINnector terminal block end cover, gray. Package of 10. For use with DN-T4 series terminal blocks.	\$5.75
<a href="#">DN-EC1/0</a>	DINnector terminal block end cover, gray. Package of 50. For use with DN-T1/0 series terminal blocks.	\$33.50
<a href="#">DN-EC1/0MN</a>	DINnector terminal block end cover, gray. Package of 10. For use with DN-T1/0 series terminal blocks.	\$8.00
<a href="#">DN-DEC10</a>	DINnector terminal block end cover, gray. Package of 50. For use with DN-D10-A series terminal blocks.	\$31.50
<a href="#">DN-DEC10MN</a>	DINnector terminal block end cover, gray. Package of 10. For use with DN-D10-A series terminal blocks.	\$6.00
<a href="#">DN-EC14</a>	DINnector terminal block end cover, gray. Package of 25. For use with DN-TL14 series terminal blocks.	\$18.00
<a href="#">DN-EC14S</a>	DINnector terminal block end cover, gray. Package of 25. For use with DN-TL14S series terminal blocks.	\$15.00
<a href="#">DN-ECM10</a>	DINnector terminal block end cover, gray. Package of 100. For use with DN-M10-A series terminal blocks.	\$43.00
<a href="#">DN-ECM10MN</a>	DINnector terminal block end cover, gray. Package of 25. For use with DN-M10-A series terminal blocks.	\$14.50
<a href="#">DN-ECKBD</a>	DINnector terminal block end cover, gray. Package of 100. For use with DN-KBD12 series terminal blocks.	\$43.00
<a href="#">DN-ECKBDMN</a>	DINnector terminal block end cover, gray. Package of 10. For use with DN-KBD12 series terminal blocks.	\$6.00
<a href="#">DN-EMXM1EC1</a>	DINnector terminal block end cover, gray. Package of 25. For use with DN-EMXM1 series terminal block leftside.	\$15.00
<a href="#">DN-EMXM1EC2</a>	DINnector terminal block end cover, gray. Package of 25. For use with DN-EMXM1 series terminal block rightside.	\$15.00
<a href="#">DN-EMXDVEC1</a>	DINnector terminal block end cover, gray. Package of 25. For use with DN-EMXDV series terminal block leftside.	\$15.00
<a href="#">DN-EMXDVEC2</a>	DINnector terminal block end cover, gray. Package of 25. For use with DN-EMXDV series terminal block rightside.	\$15.00
<a href="#">DN-FESEP</a>	DINnector terminal block end cover, gray. Package of 50. For use with DN-FE and DN-DIS series terminal blocks.	\$26.50
<a href="#">DN-FESEP-10</a>	DINnector terminal block end cover, gray. Package of 10. For use with DN-FE and DN-DIS series terminal blocks.	\$5.25
<a href="#">DN-QEC12</a>	DINnector terminal block end cover, gray. Package of 50. For use with DN-Q12-A or DN-QG12 series terminal blocks.	\$21.50
<a href="#">DN-QEC12MN</a>	DINnector terminal block end cover, gray. Package of 10. For use with DN-Q12-A or DN-QG12 series terminal blocks.	\$5.25
<a href="#">DN-QEC10</a>	DINnector terminal block end cover, gray. Package of 50. For use with DN-Q10-A or DN-QG10 series terminal blocks.	\$21.50
<a href="#">DN-QEC10MN</a>	DINnector terminal block end cover, gray. Package of 10. For use with DN-Q10-A or DN-QG10 series terminal blocks.	\$5.25
<a href="#">DN-QEC8</a>	DINnector terminal block end cover, gray. Package of 50. For use with DN-Q8-A or DN-QG8 series terminal blocks.	\$25.50
<a href="#">DN-QEC8MN</a>	DINnector terminal block end cover, gray. Package of 10. For use with DN-Q8-A or DN-QG8 series terminal blocks.	\$5.75
<a href="#">DN-QEC12-1-2</a>	DINnector terminal block end cover, gray. Package of 25. For use with DN-Q12-1-2-A series terminal blocks.	\$15.00
<a href="#">DN-QEC12-2-2</a>	DINnector terminal block end cover, gray. Package of 25. For use with DN-Q12-2-2-A series terminal blocks.	\$16.50
<a href="#">DN-QDEC12</a>	DINnector terminal block end cover, gray. Package of 25. For use with DN-QD12 series terminal blocks.	\$16.50

## Spacers

Spacers are used to put more space between adjacent blocks.

DINnectors Spacers			
Part Number	Description	Qty	Price
<a href="#">DN-S1210</a>	Spacer for DN-T12-A and DN-T10-A series terminal blocks	100	\$51.00
<a href="#">DN-S1210MN</a>		25	\$16.00
<a href="#">DN-S86</a>	Spacer for DN-T8 and DN-T6 series terminal blocks	100	\$61.00
<a href="#">DN-S86MN</a>		25	\$14.00
<a href="#">DN-EMXM1SPA1</a>	Spacer for DN-EMXM1 and DN-QEMXM1 single-level plug-in terminal blocks	25	\$13.00
<a href="#">DN-EMXDVSPA1</a>	Spacer for DN-EMXDV and DN-QEMXDV double-level plug-in terminal blocks	25	\$14.50
<a href="#">DN-FESPA</a>	Spacer for DN-FE sockets and DN-DIS disconnects	50	\$26.50
<a href="#">DN-FESPA-10</a>		10	\$5.25

## Top Covers

DINnectors Top Covers				
Part Number	Description	For Use With	Qty	Price
<a href="#">DN-C12</a>	Top cover, clear, printed electrical symbol.	DN-T12-A	100	\$62.00
<a href="#">DN-C12MN</a>			25	\$14.00
<a href="#">DN-C10</a>	Top cover, clear, printed electrical symbol.	DN-T10-A	100	\$62.00
<a href="#">DN-C10MN</a>			25	\$14.00
<a href="#">DN-C86</a>	Top cover, clear, printed electrical symbol.	DN-T8 DN-T6	100	\$62.00
<a href="#">DN-C86MN</a>			25	\$14.00
<a href="#">DN-DC10</a>	Top cover, clear, printed electrical symbol.	DN-D10	100	\$60.00
<a href="#">DN-DC10MN</a>			25	\$14.00
<a href="#">DN-MC10</a>	Top cover, clear, printed electrical symbol.	DN-M10	100	\$64.00
<a href="#">DN-MC10MN</a>			25	\$14.00

# DINnectors<sup>®</sup> Accessories

Part Number		Length mm[in]	Height mm [in]	Thickness mm [in]
<a href="#">DN-EC1210</a>	<a href="#">DN-EC1210MN</a>	44 [1.73]	35 [1.38]	1.5 [0.06]
<a href="#">DN-S1210</a>	<a href="#">DN-S1210MN</a>	55 [2.17]	44 [1.73]	
<a href="#">DN-EC86</a>	<a href="#">DN-EC86MN</a>	50 [1.97]	43 [1.69]	
<a href="#">DN-S86</a>	<a href="#">DN-S86MN</a>	55 [2.17]	49 [1.93]	
<a href="#">DN-EC4</a>	<a href="#">DN-EC4MN</a>	56 [2.21]	48 [1.89]	
<a href="#">DN-EC1/0</a>	<a href="#">DN-EC1/0MN</a>	62 [2.44]	60 [2.36]	
<a href="#">DN-DEC10</a>	<a href="#">DN-DEC10MN</a>	72 [2.80]	49 [1.93]	
<a href="#">DN-EC14</a>	-	78 [3.08]	55 [2.17]	
<a href="#">DN-EC14S</a>	-	55 [2.17]	50 [1.97]	
<a href="#">DN-ECM10</a>	<a href="#">DN-ECM10MN</a>	32 [1.26]	27 [1.06]	
<a href="#">DN-ECKBD</a>	<a href="#">DN-ECKBDMN</a>	52 [2.05]	34.5 [1.36]	
<a href="#">DN-EMXM1EC1</a>	<a href="#">DN-EMXM1EC2</a>	as shown on next page		
<a href="#">DN-EMXDVEC1</a>	<a href="#">DN-EMXDVEC2</a>			
<a href="#">DN-EMXDVSPA1</a>	<a href="#">DN-EMXM1SPA1</a>			
<a href="#">DN-FESPA</a>	<a href="#">DN-FESPA-10</a>			
<a href="#">DN-FESEP</a>	<a href="#">DN-FESEP-10</a>			
<a href="#">DN-QEC12</a>	<a href="#">DN-QEC12MN</a>	50 [1.97]	23 [0.9]	1.5 [0.06]
<a href="#">DN-QEC10</a>	<a href="#">DN-QEC10MN</a>	57.4 [2.26]	33.6 [1.32]	
<a href="#">DN-QEC8</a>	<a href="#">DN-QEC8MN</a>	63 [2.48]	38.5 [1.52]	
<a href="#">DN-QEC12-1-2</a>	-	68.5 [2.70]	28.5 [1.12]	
<a href="#">DN-QEC12-2-2</a>	-	87.5 [3.44]	28.5 [1.12]	
<a href="#">DN-QDEC12</a>	-	98 [3.86]	37 [1.46]	

**DN-EC1210 (MN), DN-EC86 (MN), DN-EC4 (MN), DN-EC1/0 (MN), DN-ECKBD (MN), DN-S1210 (MN), DN-S86 (MN)**

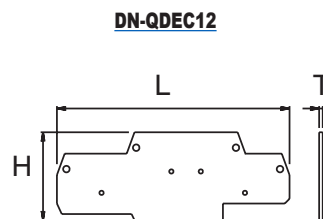
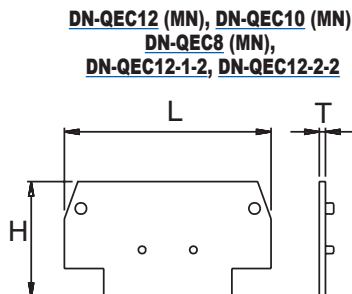
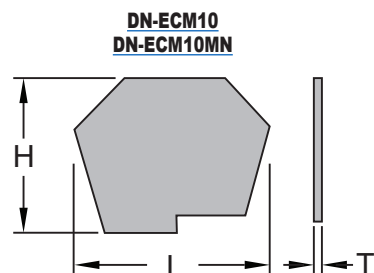
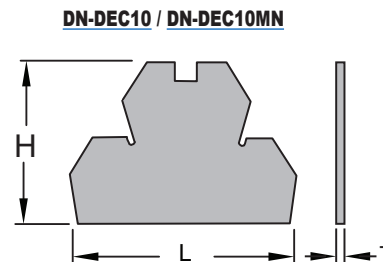
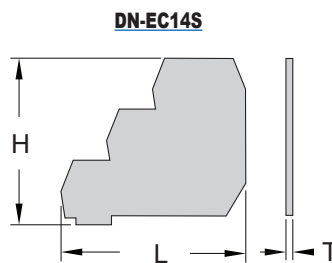
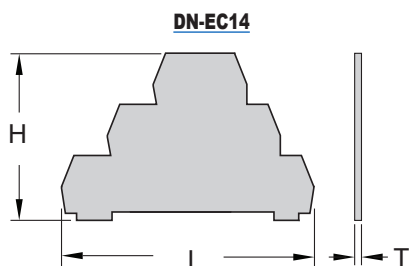
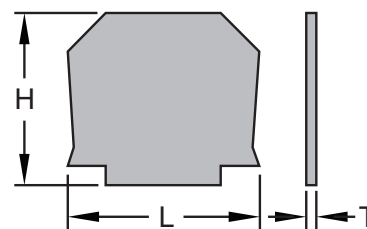

# DINnectors® Accessories

## Dimensional Drawings

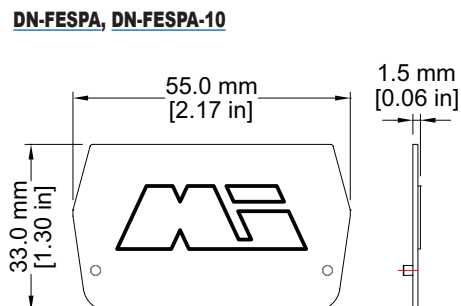
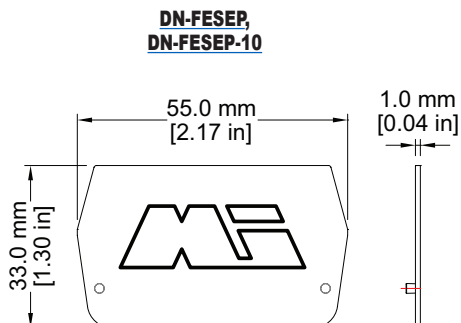
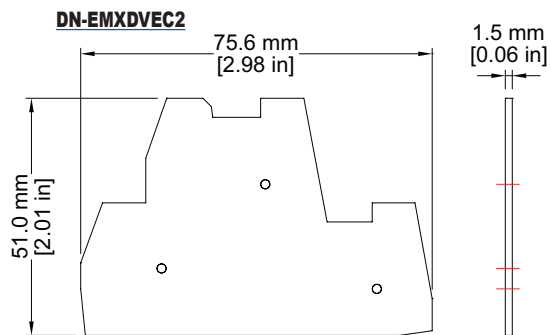
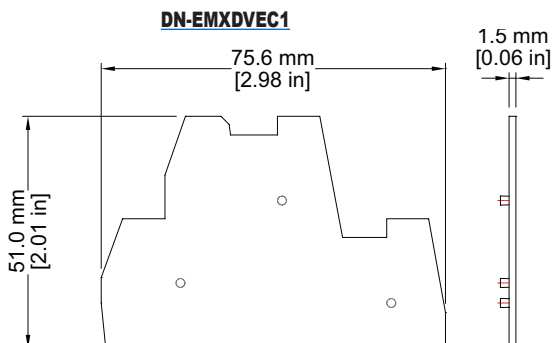
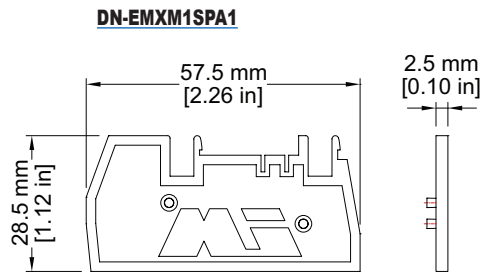
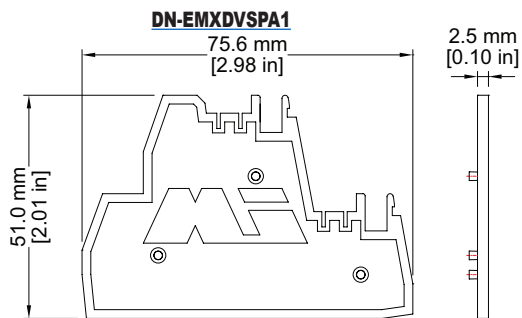
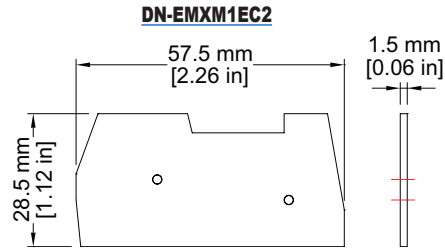
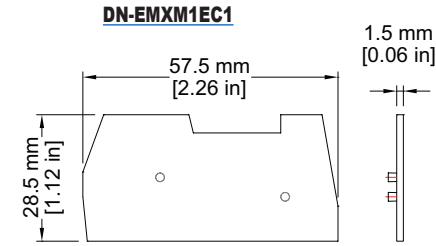

**DINnectors** Accessories

## Marking Tags Cross Reference Charts - Screwless

<b>DINector Marking Tags Cross Reference - Screwless</b>				
<i>Block Type</i>	<i>DN-QL</i>	<i>DN-LA</i>	<i>DN-LT</i>	<i>DN-EMLBL</i>
<i>DN-Q12</i>	X	-	-	-
<i>DN-Q10</i>	X	-	-	-
<i>DN-Q8</i>	X	-	-	-
<i>DN-QD12</i>	X	-	-	-
<i>DN-Q12-1-2</i>	X	-	-	-
<i>DN-Q12-1-2L</i>	X	-	-	-
<i>DN-Q12-1-2D</i>	X	-	-	-
<i>DN-QKBD</i>	X	-	-	-
<i>DN-Q12-2-2</i>	X	-	-	-
<i>DN-Q12-2-2L</i>	X	-	-	-
<i>DN-Q12-2-2D</i>	X	-	-	-
<i>DN-QEMXM1</i>	-	X	X	X
<i>DN-QEMXDV</i>	-	X	X	X
<i>DN-QG12</i>	X	-	-	-
<i>DN-QG10</i>	X	-	-	-
<i>DN-QG8</i>	X	-	-	-
<i>DN-QG12-1-2</i>	X	-	-	-
<i>DN-QG12-2-2</i>	X	-	-	-

## Marking Tags

Marking Tags DN-L Series			
Part Number	Marking Sequence	Qty	Price
<a href="#">DN-L50</a>	1-50	500	\$56.00
<a href="#">DN-L100</a>	51-100	500	\$56.00
<a href="#">DN-L150</a>	101-150	500	\$56.00
<a href="#">DN-L200</a>	151-200	500	\$56.00
<a href="#">DN-L250</a>	201-250	500	\$56.00
<a href="#">DN-L300</a>	251-300	500	\$56.00
<a href="#">DN-L350</a>	301-350	500	\$56.00
<a href="#">DN-L400</a>	351-400	500	\$56.00
<a href="#">DN-L450</a>	401-450	500	\$56.00
<a href="#">DN-LB</a>	Blank	500	\$38.00
<a href="#">DN-LS</a>	L1, L2, L3, L, N, GND, +, -, COM,COM*	500	\$56.00

**Dimensions**

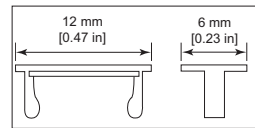

- The marking sequence of 50 tags (i.e. 101-150) is printed 10 times in each package of 500.
- The DN-L tags fit all DINnectors 6mm wide and wider.
- There will be a gap between tags on blocks wider than 6mm.
- Material: Thermoplastic with heat embossed black print.

Marking Tags DN-LA Series			
Part Number	Marking Sequence	Qty	Price
<a href="#">DN-LA100</a>	1-100	500	\$56.00
<a href="#">DN-LA200</a>	101-200	500	\$56.00
<a href="#">DN-LA300</a>	201-300	500	\$56.00
<a href="#">DN-LA400</a>	301-400	500	\$56.00
<a href="#">DN-LAB</a>	Blank Tags	500	\$56.00
<a href="#">DN-LAS</a>	L1, L2, L3, L, N, GND, +, -, COM,COM*	500	\$56.00

**Dimensions**

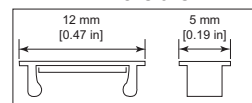

- The marking sequence of 100 tags (i.e. 1-100) is printed five times in each package of 500.
- The DN-LA tags fit all DINnectors 5mm wide and wider. There will be a gap between tags on blocks wider than 5mm.
- Material: Thermoplastic with heat embossed black print.

Marking Tags DN-LAT Series			
Part Number	Marking Sequence	Qty	Price
<a href="#">DN-LAT100-A</a>	1-100	500	\$49.00
<a href="#">DN-LAT200-A</a>	101-200	500	\$49.00
<a href="#">DN-LAT300-A</a>	201-300	500	\$49.00
<a href="#">DN-LAT400-A</a>	301-400	500	\$49.00
<a href="#">DN-LAT500-A</a>	401-500	500	\$49.00
<a href="#">DN-LAT600-A</a>	501-600	500	\$49.00
<a href="#">DN-LATB-A</a>	Blank Tags	500	\$35.50
<a href="#">DN-LATS-A</a>	L1, L2, L3, L, N, +, -, COM,COM*	500	\$49.00

**Dimensions**

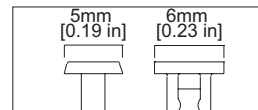

- The marking sequence of 500 tags (i.e. 1-100) is printed five times in each package of 500.
- Material: Thermoplastic with heat embossed black print.

Marking Tags DN-QL Series			
Part Number	Marking Sequence	Qty	Price
<a href="#">DN-QL100</a>	1-100	500	\$42.50
<a href="#">DN-QL200</a>	101-200	500	\$42.50
<a href="#">DN-QL300</a>	201-300	500	\$42.50
<a href="#">DN-QL400</a>	301-400	500	\$42.50
<a href="#">DN-QL500</a>	401-500	500	\$42.50
<a href="#">DN-QLB</a>	Blank Tags	500	\$36.00
<a href="#">DN-QLS</a>	L1, L2, L3, L, N, +, -, COM,COM*	500	\$49.00

**Dimensions**

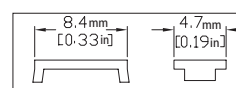

- The marking sequence of 500 (i.e. 1-100) is printed five times in each package of 500.
- Material: Thermoplastic with heat embossed black print.

# DINnectors® Accessories

## Marking Tags continued

Marking Tags DN-LT Series			
Part Number	Marking Sequence	Qty	Price
<a href="#">DN-LT15</a>	1-5	100	\$10.00
<a href="#">DN-LT60</a>	6-0	100	\$10.00
<a href="#">DN-LT1</a>	1	100	\$10.00
<a href="#">DN-LT2</a>	2	100	\$10.00
<a href="#">DN-LT3</a>	3	100	\$10.00
<a href="#">DN-LT4</a>	4	100	\$10.00
<a href="#">DN-LT5</a>	5	100	\$10.00
<a href="#">DN-LT6</a>	6	100	\$10.00
<a href="#">DN-LT7</a>	7	100	\$10.00
<a href="#">DN-LT8</a>	8	100	\$10.00
<a href="#">DN-LT9</a>	9	100	\$10.00
<a href="#">DN-LT0</a>	0	100	\$10.00
<a href="#">DN-LTBLNK</a>	Unprinted	100	\$10.00
<a href="#">DN-LTA</a>	A	100	\$10.00
<a href="#">DN-LTB</a>	B	100	\$10.00
<a href="#">DN-LTC</a>	C	100	\$10.00
<a href="#">DN-LTD</a>	D	100	\$10.00
<a href="#">DN-LTE</a>	E	100	\$10.00
<a href="#">DN-LTF</a>	F	100	\$10.00
<a href="#">DN-LTG</a>	G	100	\$10.00
<a href="#">DN-LTH</a>	H	100	\$10.00
<a href="#">DN-LTI</a>	I	100	\$10.00
<a href="#">DN-LTJ</a>	J	100	\$10.00
<a href="#">DN-LTK</a>	K	100	\$10.00
<a href="#">DN-LTL</a>	L	100	\$10.00
<a href="#">DN-LTM</a>	M	100	\$10.00
<a href="#">DN-LTN</a>	N	100	\$10.00
-	-	-	-
<a href="#">DN-LTP</a>	P	100	\$10.00
<a href="#">DN-LTQ</a>	Q	100	\$10.00
<a href="#">DN-LTR</a>	R	100	\$10.00
<a href="#">DN-LTS</a>	S	100	\$10.00
<a href="#">DN-LTT</a>	T	100	\$10.00
<a href="#">DN-LTU</a>	U	100	\$10.00
<a href="#">DN-LTV</a>	V	100	\$10.00
<a href="#">DN-LTW</a>	W	100	\$10.00
<a href="#">DN-LTX</a>	X	100	\$10.00
<a href="#">DN-LTY</a>	Y	100	\$10.00
<a href="#">DN-LTZ</a>	Z	100	\$10.00
<a href="#">DN-LTGND</a>	⊕	100	\$10.00
<a href="#">DN-LTPOS</a>	+	100	\$10.00
<a href="#">DN-LTNEG</a>	-	100	\$10.00
<a href="#">DN-LTAC</a>	~	100	\$10.00
<a href="#">DN-LTDC</a>	=	100	\$10.00

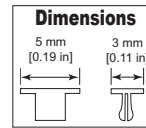

- These marking tags allow the flexibility of creating custom marking sequences on site.
- The DN-M series supports a maximum of three digits (tags), while other DINnectors support up to four digits (tags).
- Material: Thermoplastic with heat embossed black print.

### DN-MTA marking tag adapter

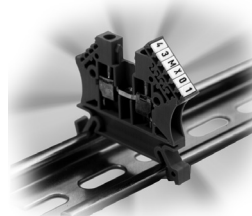

### DN-MTA dimensions

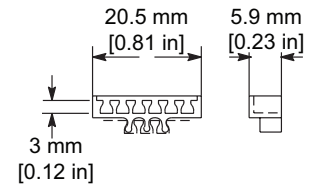

Part Number	Description	Qty	Price
<a href="#">DN-MTA</a>	Marking tag adapter holds up to six DN-LT tags	50	\$14.50

Note: [DN-MTA](#) adapter does not fit [DN-T12-A](#) terminal blocks.

# DINnectors® Accessories

## Terminal Marking Accessories



**DN-EMLBL1**



**DN-EMLBL2**



**DN-EMLBL3**

Part Number	Description	For Use With	Qty	Price
<b>DN-EMLBL1</b>	Blank labels	DN-EMPEG1 pin protectors for DN-xEMxx plug-in terminal blocks	100	\$9.25
<b>DN-EMLBL2</b>	Labels printed 1 – 12		100	\$13.00
<b>DN-EMLBL3</b>	Labels printed 13 – 24		100	\$13.00

## Marking Pen – for terminal and wire marking tags

- Permanent
- Smudge-proof
- Waterproof
- Weatherproof
- Lightfast (won't fade)
- Dries in seconds (excellent for left-handed users)
- Dry-safe (pen can be left uncapped for days without drying out)
- Low odor ink

Part Number	Description	Qty	Price
<b>DN-MP</b>	Staedtler-Mars marking pen, for use with blank marking tags. Permanent Ink, fine tip.	1	\$4.50

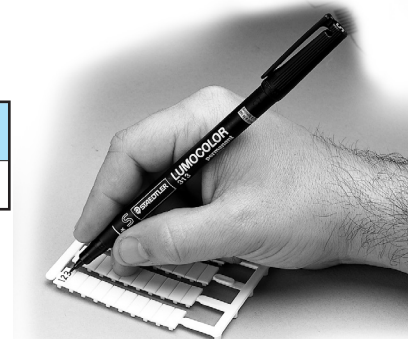

**Marking pen**

## Wire Marking Accessories



**DN-WMTAG1 wire tags & DN-WM-x wire tag holders**

Part Number	Description	For Use With	Qty	Price
<b>DN-WMTAG1</b>	Wire tag – blank	all DN-WM-x wire tag holders	525	\$60.00
<b>DN-WM-1</b>	Wire tag holder, clear, 12mm length, 0.051–0.118 in diameter; for 22–16 AWG wire	<b>DN-WMTAG1</b>	200	\$12.50
<b>DN-WM-2</b>	Wire tag holder, clear, 12mm length, 0.098–0.196 in diameter; for 16–11 AWG wire		200	\$12.50
<b>DN-WM-3</b>	Wire tag holder, clear, 12mm length, 0.157–0.393 in diameter; for 13–5 AWG wire		100	\$8.25
<b>DN-WM-4</b>	Wire tag holder, clear, 12mm length, 0.314–0.629 in diameter; for 5AWG wire		100	\$7.75