

ASO Safety Solutions

SENTIR Diamond Plate

Straight Edge Safety Contact Mats

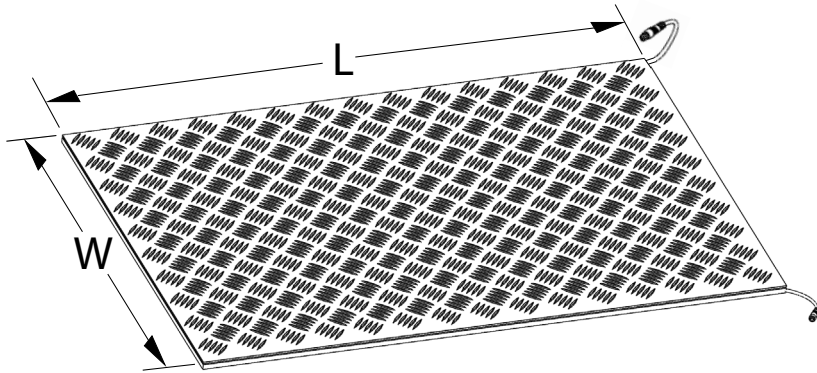

SENTIR safety contact mats are rectangular sections which are used to safeguard dangerous areas in industrial and production automation settings. Stepping on the mat triggers an immediate "stop" signal in order to prevent endangering movements.

SENTIR Straight Edge mats are designed with flexibility in mind. Two quick-disconnect ends allow for easy single or multi-mat wiring in either 2-wire or 4-wire circuits with optional terminating resistor. The straight edge allows butting of additional mats and use of optional metal trim kits for securing to the floor.

Features

- Diamond plate sheet included to protect in harsh conditions
- Straight edge ideal for trim kits and multi-mat configurations
- Ideal for 2-wire circuits with optional terminating resistor
- Can wire in 2-wire or 4-wire circuits
- Male and female quick disconnect
- Two sizes available
- Resistant to most contaminants and moisture up to IP65

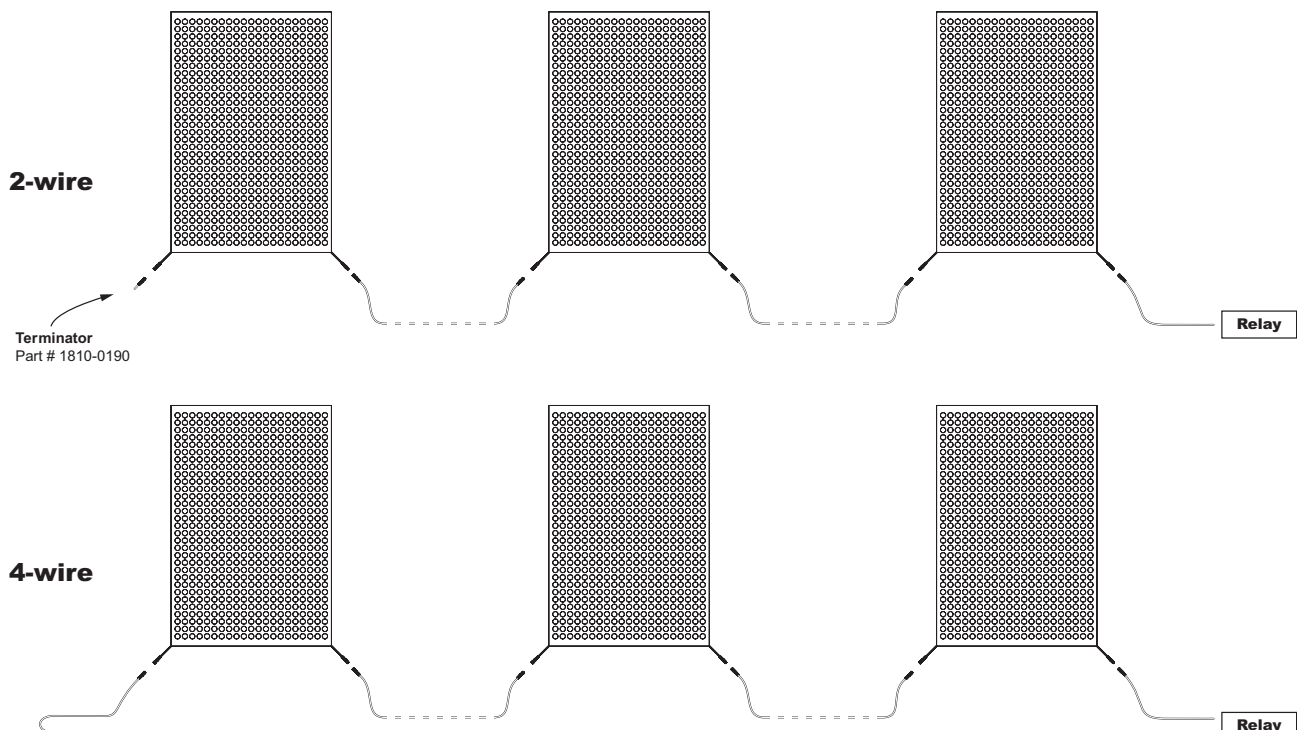

ASO Safety Solutions SENTIR Diamond Plate Straight Edge Safety Contact Mats

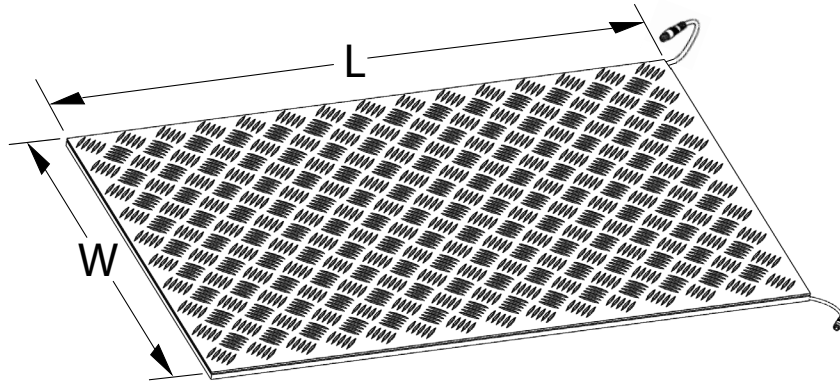

M8 Connector

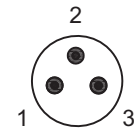

Use pins 1 and 3 for continuity.
(See safety relay for wiring)

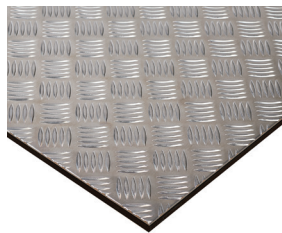

1602-4540

ASO Safety Solutions Contact Mats - Straight Edge Style							
Part Number	Price	Width (W)	Length (L)	Operating Voltage	Cable Length	Connection Cables	Drawing
1602-4540	\$574.00	24in [609.6 mm]	36in [914.4 mm]	24VDC, 100mA	There are two cables; each is 4.7 inches [120mm] in length	One cable has a 3-pin male M8 connector, and the other cable has a 3-pin female M8 connector	PDF
1602-4550	\$695.00	24in [609.6 mm]	48in [1219.2 mm]				PDF



1810-0190

ASO Safety Solutions Terminating Resistors					
Part Number	Price	Description	Use With	Contents	Drawing
1810-0190	\$8.75	Terminating resistor, 8.2 k ohm, 3-pin male M8 connector	Safety contact mats and bumpers	1 resistor	PDF

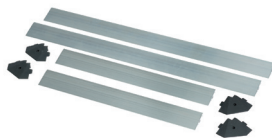

2010-0080

ASO Safety Contact Mat Trim Kits and Corners						
Part Number	Price	Description	Material	Use With	Contents	Drawing
2010-0080	\$97.00	Trim kit	Aluminum	24 x 36 in safety mats	4 trim corners and 4 mat trim pieces	PDF
2010-0081	\$107.00	Trim kit	Aluminum	24 x 48 in safety mats	4 trim corners and 4 mat trim pieces	PDF
2010-0086	\$56.00	Mat trim	Aluminum	Safety contact mats	1 mat trim, 5ft [1524mm] length	PDF
2010-0087	\$3.75	Trim corner	Polyamide	Safety contact mats	1 corner	PDF



2010-0086



2010-0087

Straight Edge Safety Contact Mats	
	General Specifications
Height	14mm [0.55 in] with covering
Material	Polyurethane and aluminum diamond plate surface
Weight	31.5 kg/m ² [6.45 lb/ft ²]
Switching Pressure	Test piece Ø 80mm [3.15 in] = approximately 150N
Inactive Edge	30mm [1.18 in] without optional trim installed 40mm [1.57 in] with optional trim installed
Static Load	Max. 2,000N on Ø 80mm [3.15 in], tested according to DIN EN ISO 13856-1
Response Time	< 25ms, tested according to DIN EN ISO 13856-1
Electrical Capacity	24VDC, 100mA
Mechanical Life	>1,000,000 cycles
Protection Class	IP65
Temperature Range	-20° to +55°C [-4° to +131°F]
Agency Approvals	CE, cULus file E329422

ASO Safety Solutions SENTIR Diamond Plate Straight Edge Safety Contact Mats

Dimensions

mm [in]

Contact Mats - Straight Edge (1602-41XX)

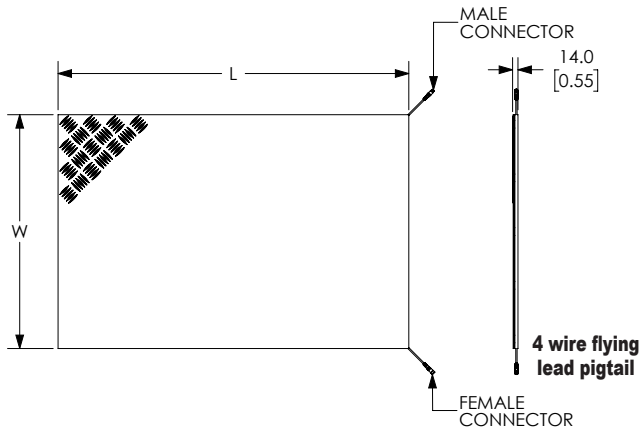

Trim Kits (2010-008X)

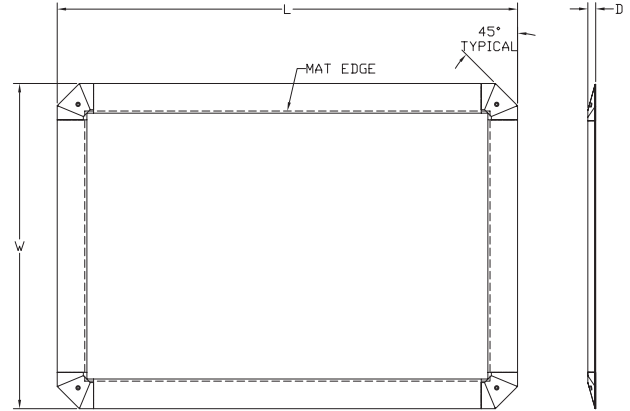

Part Information – Contact Mats (Straight Edge)

Part number	W mm (in)	L mm (in)	D mm (in)
1602-4540	609.6 (24)	914.4 (36)	14 (0.55)
1602-4550		1219.2 (48)	

Part Information – Trim Kits

Part number	W mm (in)	L mm (in)	D mm (in)
2010-0080	733.5 (28.88)	1038.3 (40.88)	17.8 (0.70)
2010-0081		1343.1 (52.88)	

Mat Trim (2010-0086)

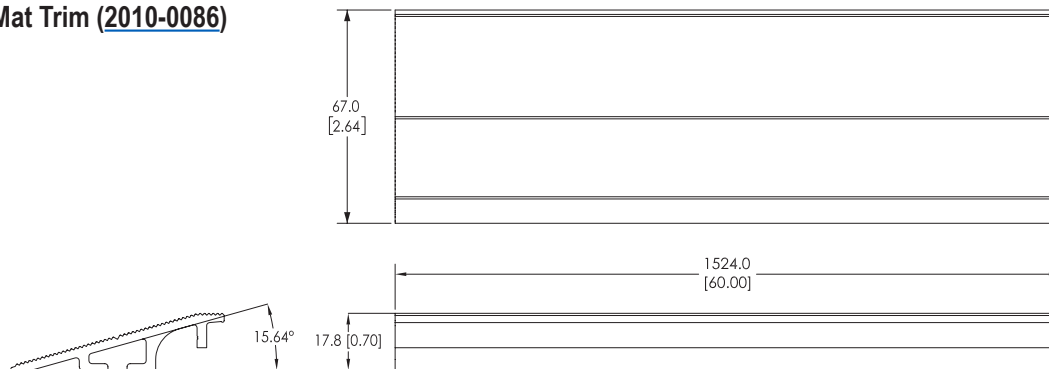

Trim Corner (2010-0087)

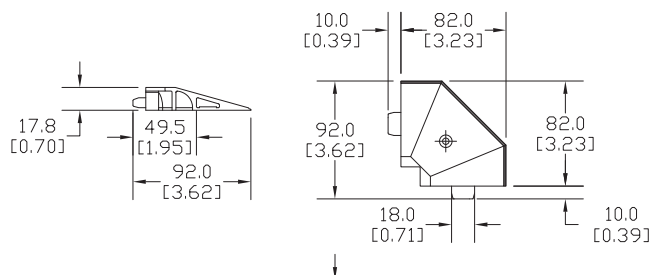

Terminating Resistor (1810-0190)

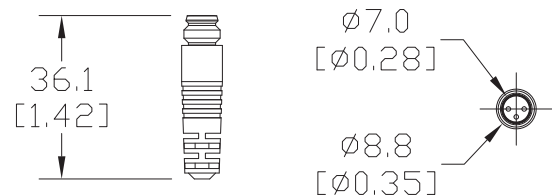

See our website: www.AutomationDirect.com for complete Engineering Drawings.

Safety Products



Warning: Safety products sold by AutomationDirect are Safety components only. The purchaser/installer is solely responsible for the application of these components and ensuring all necessary steps have been taken to assure each application and use meets all performance and applicable safety requirements and/or local, national and/or international safety codes as required by the application. AutomationDirect cannot certify that our products, used solely or in conjunction with other AutomationDirect or other vendors' products, will assure safety for any application. Any person using or applying any products sold by AutomationDirect is responsible for learning the safety requirements for their individual application and applying them, and therefore assumes all risks, and accepts full and complete responsibility, for the selection and suitability of the product for their respective application.

AutomationDirect does not provide design or consulting services, and cannot advise whether any specific application or use of our products would ensure compliance with the safety requirements for any application.