



STAINLESS STEEL
REGALINE
CORNER SINKS

NEW *Tile Edge Design*



Item #: _____ *Qty #:* _____
Model #: _____
Project #: _____

All units furnished with 2 integral drainboards



Optional Poly-Vance Cutting Boards Available

FEATURES:

- Tile edge for ease of installation.
- One piece **Deep Drawn** sink bowls with integral drainboards with splash.
- Featuring the single bowl unit design.
- All sink bowls have a large liberal 3" radius (10"x14" bowls have 2" Radius).
- Placement of the welded leg assembly ensures stability and furnishes direct support of the column load requirement for the entire sink unit.

CONSTRUCTION:

- All TIG welded.
- Welded areas blended to match adjacent surfaces and to a satin finish.
- Gussets welded to a die-embossed reinforcing channel.

MATERIAL:

- Unit is 16 gauge, type "304" stainless steel.
- Legs are 1 5/8" diameter heavy gauge tubular stainless steel with stainless steel gussets.
- 1" adjustable stainless steel bullet feet.

YES! It's SeaLess!

MODEL #	# of Comp.	Wall Dimension	Optional Poly-Vance Cutting Board
94-K2-24D	3	71" x 71"	K-2E
94-K4-24D	3	79" x 79"	K-2F
94-K5-18D	4	79 1/2" x 61"	K-2E
94-K6-18D	3	61" x 61"	K-2E
94-K8-30D	3	85" x 85"	K-2E
94-K3-11D	3	54" x 54"	K-2H
94-K5-11D	3	42" x 42"	K-2H

ACCESSORIES	Model #	Qty
FAUCETS		

All Units Require 2 Sets of Faucets



Customer Service Available To Assist You 1-800-645-3166 8:30 am - 8:00 pm E.S.T.
 Email Orders To: customer@advancetabco.com. For Smart Fabrication™ Quotes, Email To: smartfab@advancetabco.com or Fax To: 631-586-2933

NEW YORK
 Fax: (631) 242-6900

GEORGIA
 Fax: (770) 775-5625

TEXAS
 Fax: (972) 932-4795

NEVADA
 Fax: (775) 972-1578

DIMENSIONS and SPECIFICATIONS

TOL Overall: ± .500"
Interior: ± .250"

ALL DIMENSIONS ARE TYPICAL

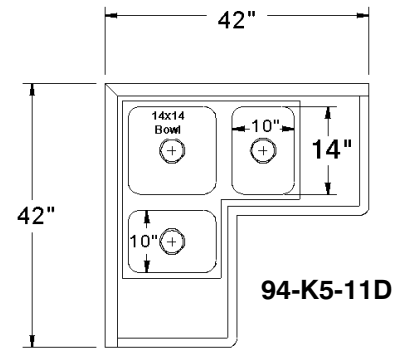
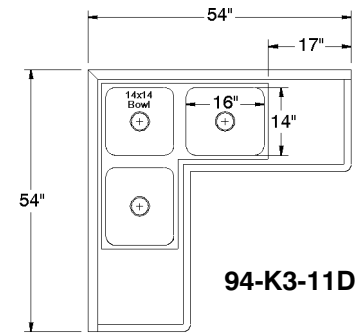
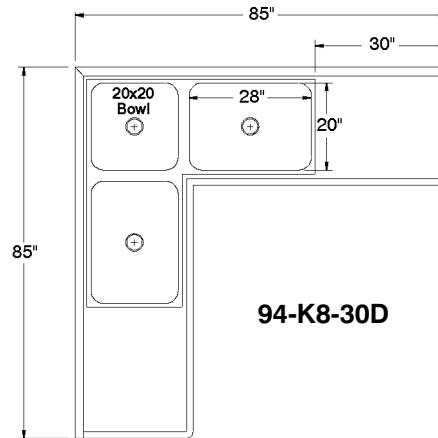
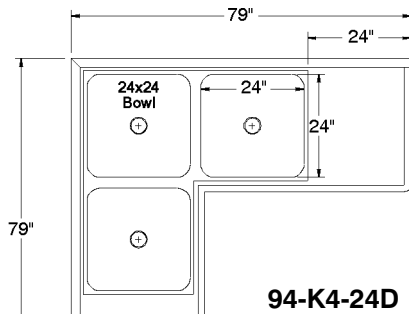
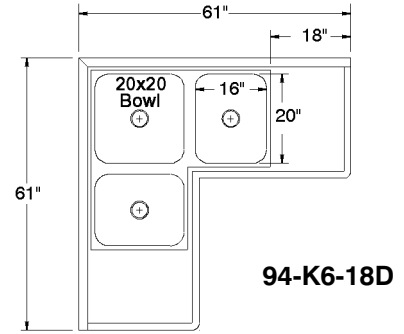
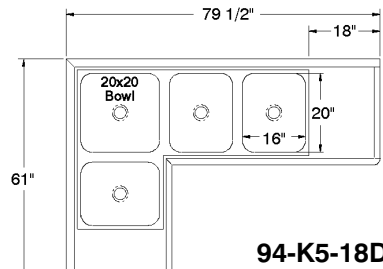
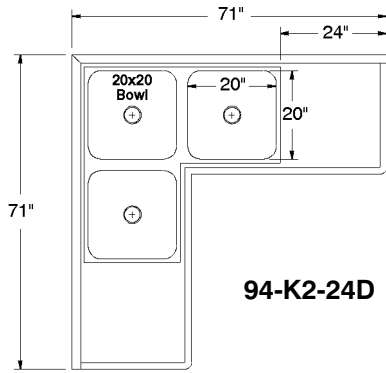

MECHANICAL:

- Supply is 1/2" IPS hot & cold.
- Faucet holes on 8" centers.
- Faucets are not included (**see accessories**).
- Waste drains are 1 1/2" IPS S/S basket type, located in center of sink bowl, and are included.

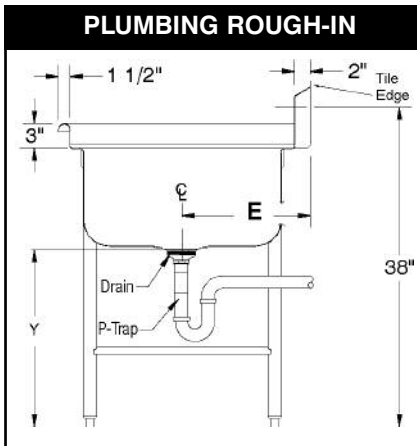

Model #	A	B	C	D	E	Y
94-K2-24D	15"		27"	20"	13 5/8"	22"
94-K4-24D	15"	12"	31"	24"	15 5/8"	22"
94-K5-18D	15"	12"	27"	20"	13 5/8"	22"
94-K6-18D	15"	12"	27"	20"	13 5/8"	22"
94-K8-30D	15"	12"	27"	20"	13 5/8"	22"
94-K3-11D	15"	12"	21"	14"	10 5/8"	22"
94-K5-11D	13"	10"	21"	14"	10 5/8"	24"

